

**THE 2016 COUNTER BOOK**  
***Central Supply*** & Rubber  
***Company***

*109 North 9th Street \* Omaha, Nebraska 68102*

**Telephone (402) 341-6977 or Fax (402) 341-0860**

*Wholesale Farm & Industrial Parts & Supplies Since 1944!*

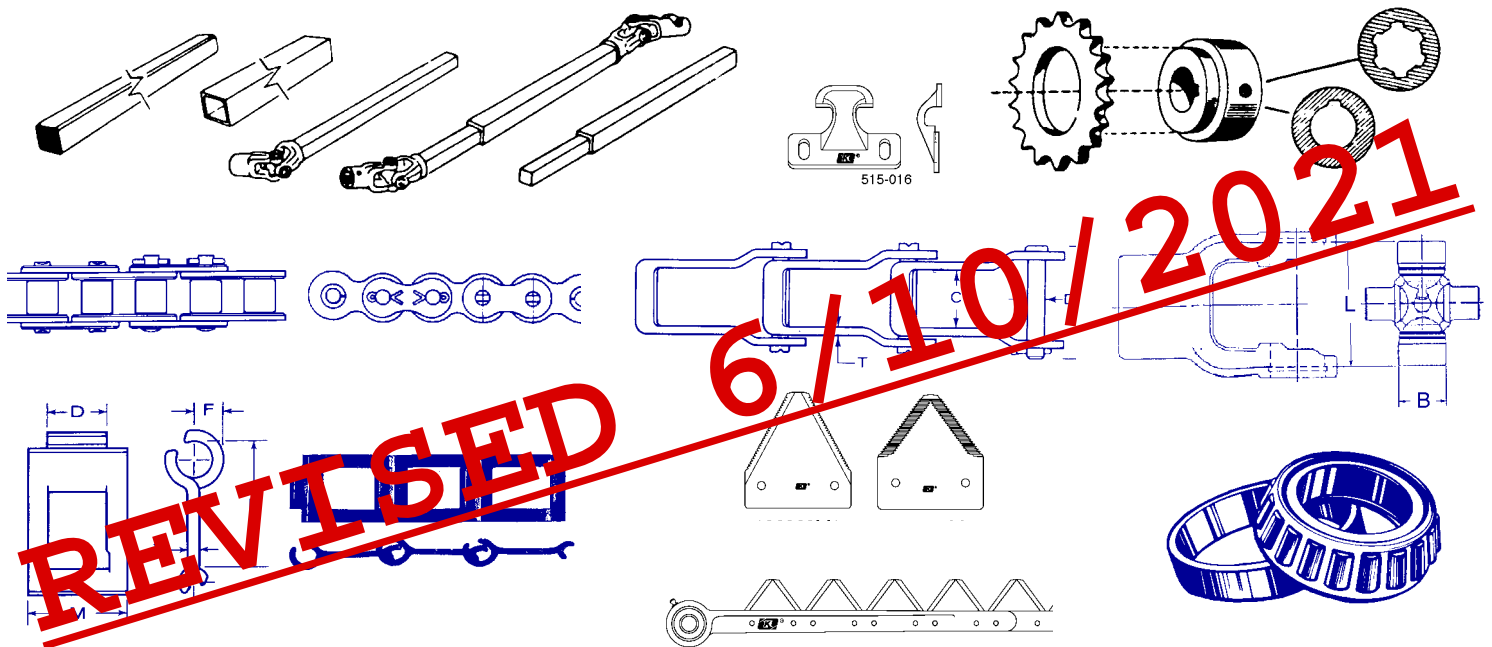

*We Ship Over 98% Of Our Orders The Same Day!*

**To Order Call Toll-Free**  
**1-800-444-8666**

**Or Fax Toll-Free 1-800-342-7252**

Visit Our Web Site at: [www.centuralsupplyandrubber.com](http://www.centuralsupplyandrubber.com)

# *The Policy of Central Supply & Rubber Company*

is to conduct our business in an honest straight forward manner, distribute well known quality merchandise at legitimate prices and render the best possible service at all times.

You can expedite shipment of your order by using the order number and description of merchandise shown on the pages of this book. Avoid delays and shortages by checking your bills against merchandise received at the time the carrier makes delivery. Insist that the carrier's representative makes a notation on the freight bill of all shortages at time of delivery.

There will be a handling charge made against all goods returned for credit when order for the same has been filled correctly by us. We will not accept merchandise returned for credit without first obtaining our consent. All merchandise sold by us is guaranteed to the degree as specified in the manufacture's warranty. We do not assume responsibility for merchandise damaged by accident or misuse.

For open account customers, payment on standard invoices is due by the tenth of the following month. A discount may be allowed for early payment when noted on your invoice. Invoices not paid by the twentieth of the following month are subject to finance charges of 1-1/2% per month (18% per annum), with a \$2.00 minimum charge. A fee of \$25.00 will be charged for any check submitted for payment that is returned to us due to insufficient funds.

Unless otherwise noted all items are shipped FOB Omaha, Nebraska. Due to market conditions all prices in this catalog and otherwise published by our company are subject to change without notice.

*Centralize* your buying with *Central Supply & Rubber Company* and you'll see why we've been in business serving agriculture and industry since 1944. Your business is appreciated.

Yours Truly,

*Jack Swanson*

Jack Swanson II  
President



In memory of  
Jack William Swanson, Sr.  
1913 - 1998  
*We All Miss You Greatly!*

Central Supply & Rubber Company was founded by E.E. Thomas, Orville Goecker, Harry Goecker, George McPherson, Victor Enholm, Harry Schropp, and Jack Swanson, on June 30, 1944.

## How To Get To *Central Supply*

**109 North 9th St.  
Omaha, Ne. 68102**

**From I-480 East Bound:** Take the 14th Street exit and turn left at the first set of traffic lights (Capitol Ave.). Go 5 Blocks to 9th Street and turn right.

**From I-480 West Bound:** Take the Dodge Street exit (1st exit after crossing the Missouri River). Turn right at the first set of traffic lights (10th Street). Go 1 block to Capitol Ave. and turn right. Go 1 block to 9th Street and turn right.

We are directly south across the street from the Century Link Arena.

**If you need further directions  
feel free to call us at:**

**(402) 341-6977 or Toll-Free: 1-800-444-8666**

**Accepting  
MasterCard & Visa**

**Catalog Index**

## A

ABM Milo Guards .....	47-49
Abrasive - - Discs .....	140
Roll .....	141
Ace Centrifugal Pump .....	263
Acme - - Nuts .....	142
Threaded Rod .....	142
Acreage Counter .....	50-51
Adapter - - Hydraulic .....	67-86
PTO .....	173-176
Pump .....	175-177, 262
Spline .....	173-177
Swivel - Hydraulic .....	80-86
Aetna - - Belt Idler .....	221
Adapter Bearings .....	221
Idler Sprocket .....	220
Agitator .....	266
Air - - Chuck .....	242
Coupler .....	242
Filter - Furnace .....	261
Hose .....	242
Air Craft Cable .....	163
Allen Wrenches .....	155
Anti - - Seize Compound .....	238
Spatter (Welder's) .....	236
Attachment Links .....	168-172
Auger - - Bearing .....	98, 221
Hopper Strapes .....	51
Automotive U-Joint Kits .....	181
Aviation Snips .....	136

## B

Back-Up Washers .....	87
Bags - - Brown Kraft .....	240
Poly .....	241
Bait - Gopher .....	52
Baler - Chain .....	171
Ball Bearings .....	92-110
Ball Sockets - - 3 Pt. ....	116-117
Trailer .....	125
Valves .....	269
Band Saw Blades .....	128
Bandana - Cool Care .....	129
Banjo Fittings .....	274
Barrel Pumps .....	244, 246
Batteries - Fencer .....	249
Flashlight .....	139
Battery - - Bolt .....	148, 232
Cable .....	232
Clamp .....	232
Cleaner .....	232-233
Heater .....	254
Sealant .....	233
Terminal .....	232
Bead Breaker - Tire .....	259
Beal - Flail Shredder Components ...	46
Bearing - - Adapter .....	221
Angular, Ball, Bronze,	
Disc, Flange, Housing, Pillow	
Block, Radial, Tapered .....	92-110
Gage Wheel/Water Pump .....	11, 95
Kit - - U-Joint .....	181-196, 200
Packer .....	108

## B (continued)

Bearing (continued)	
Shield Kit .....	181-196, 199
Belt - - Dressing .....	223
Pulley-V .....	221-226
V .....	227-229
Bent Pins .....	120
Big Orange .....	121-122
Bin - - Boxes .....	240-241
Parts .....	240-241
Bits - Drill .....	130-132
Black Pipe Fittings .....	90-91
Blades - - Band Saw .....	127
Hacksaw .....	127
Sawzall .....	126
Blow Guns .....	242
Bolster Hoist .....	62
Bolt Cutter .....	136
Bolts .....	142-148
Guard - Kondex .....	32
Bolt-On - - Section Bolts-Kondex ....	32
Sickles-Kondex .....	12-40
Sickle Tool .....	41
Booster Cables .....	232
Boxes - - Bin .....	240
Mail .....	261
Parts .....	240-241
Tool .....	242
Brake Cleaner .....	237
Breakaway Couplings .....	67.72
Breakout Punch .....	139
Breather Filter .....	66
Bronze Bushings .....	98
Brush - - Parts .....	141
Scratch .....	140
Wire .....	140-141
Buchanan - - Guards .....	42-44
Buggy Tops .....	247-248
Bull Dog Jacks .....	124
Bushings - - Bronze .....	98
Machinery .....	152
Stock .....	198
Three Point .....	116, 118
Weld-A-Joint .....	207-208

## C

C-Clamp .....	135
Vise Grip .....	133
Cable - - Aircraft .....	163
Booster .....	232
Clamp .....	163
Farm .....	163
Loom .....	232
Thimbles .....	163
Ties .....	233
Wire Rope .....	163
Cabinets - - Parts .....	240-241
Cab Heaters .....	253
Calipers .....	129
Canopy - - Buggy .....	247-248
Cap - - Screws - Hex Hd. ....	145-147
Screws - Socket Hd. ....	155
Weather .....	246

## C (continued)

Carriage Bolts .....	148
Castle Nuts .....	150
Centrifugal Pumps .....	263
Chain - - Attachment Links .....	168-172
Baler .....	171
Binder .....	166
Breaker .....	167
Coupler .....	211
Detacher .....	167, 169
Drives .....	168
Feed Wagon .....	171
Hi-Test .....	165
Hooks - - Grab .....	164-165
Implement .....	170
Log .....	166
Lubricant .....	169
Missing Links .....	164
Pintle .....	172
Proof Coil .....	165
Quick Tach .....	171
Repair Tool .....	167
Roller .....	168-170
Roller Links .....	168-170
Side .....	260
Spreader Conveyor .....	171-172
Steel Detachable .....	170
T Bar .....	171
Tighteners .....	166
Tire .....	258-260
Tool .....	167
Tow .....	165-166
Twist Link .....	260
Wrench .....	133
Check Valve .....	266
Chisel .....	137-138
Chuck-Air .....	242
Clamps - - C .....	133, 136
Cable .....	163
Hose .....	253
Welders .....	133-134
Cleaner - - Brake .....	237
General Purpose .....	237
Mean Green .....	239
Parts .....	237
Sprayer-Golden Rod .....	242
Clevis .....	121-122
Cylinder .....	65
Pins .....	66, 156
Coiled Spring Pins .....	156
Cold Shuts .....	164
Collars - - Bearing .....	96
Hexagon .....	208
Solid Shaft .....	153
Split Shaft .....	153
Combination Wrenches .....	135
Compression - - Springs .....	160-161
Stop Valve .....	269
Connecting Links .....	168-170
Contact Cleaner - Spray-On .....	233
Control - - Sprayer-Electric .....	264
Conversion System - 3 Point .....	115
Conveyor Chain .....	172

## Catalog Index

C (continued)	E	G (continued)
Cool Gel ..... 238	E Rings ..... 157	Gate - - Grain ..... 51
CoolCare Bandana ..... 129	Elbows - - Nylon ..... 272	Handles - Dare ..... 251
Corn Picker Pins ..... 156	Pipe ..... 90	Valves ..... 269
Cotter - - Hair Pin ..... 159	Electrical - - Cleaner-Lubricant ..... 233	Gauge - - Bolt & Nut ..... 151
Keys ..... 159	Tape ..... 239	Rain ..... 261
Coupler - - Air ..... 242	Terminals ..... 231-232	Screw Pitch ..... 129
Hubs ..... 216	Elevator Bolts ..... 148	Sprayer ..... 263
Hydraulic ..... 67-72	Elliptic Head Bolt ..... 47, 144	Thread ..... 129, 151
Overrunning ..... 174	Elston Gopher Getter ..... 52-55	G & G Merchandise 123, 177, 197-223
Shaft ..... 209	Emblems-Vehicle ..... 234	Gib Keys ..... 160
Coupling-Air-Water-Steam ..... 91	Emery Cloth ..... 141	Glasses - Safety ..... 129
Flexible-G & G ..... 209-211	End Section ..... 33	Goggles ..... 129
Hydraulic ..... 67-72	Engine - - Degreaser ..... 237, 239	Golden Rod - - Blow Gun ..... 242
Jaw ..... 210	Heaters ..... 253-254	Fuel Filter ..... 246
Nuts ..... 142	Hour Meter ..... 234	Oil Cans ..... 245
Sprayer - Nylon ..... 272	EVA Tubing ..... 274	Spray Cleaner ..... 242
Sprockets ..... 211	Exhaust - - Caps ..... 246	Winches ..... 125
Cross & Bearing Kits ..... 181-196, 200	Clamps ..... 246	Gopher - - Bait ..... 52
Cross Chains-Tractor Tire ..... 258-260	Expan Pins ..... 156-157	Getter-Elston ..... 52-55
CTC Pliers ..... 135	Extension Springs ..... 160-161	Grab Hooks ..... 122, 164-165
Cultivator - - Gauge Wheel ..... 11	Extractor - Screw & Pipe ..... 130	Grader Tire Chains ..... 259
Shovels ..... 47	F	Grain - - Gate ..... 51
Spring Devil ..... 10-11	Farm - - Cable ..... 163	Guards ..... 42-44
Sweeps ..... 47	Jacks ..... 123-125	Hopper Straps ..... 51
Cup Brush ..... 140	Feed Wagon Lift Chain ..... 171	Thermometer ..... 51
Cutter - Hose ..... 275	Femco Weatherbrake ..... 255-257	Graphite - Powdered ..... 235
Cutting - - Oil ..... 128-129	Fence - Controller-Electric ..... 249-252	Spray ..... 235
Wheel ..... 140	Pliers ..... 251-252	Grass Boards ..... 45
Cylinders-Hydraulic ..... 62, 64-65	Post ..... 248	Grease - - Cartridge ..... 244
Pins ..... 66	Stretcher ..... 248	Coupler ..... 244
Repair Kit ..... 62, 65-66	Wire ..... 248	Fittings ..... 243
D	Fender Washers ..... 151	Guns ..... 244
Dare Fencing Products ..... 250-252	Filter - - Breather-Hydraulic ..... 66	Gun Fillers ..... 244
Degreaser Compound ..... 237, 239	Fuel ..... 246	Gun Holders ..... 245
Delevan - - Pump ..... 263	Furnace-Purolator ..... 261	Hose ..... 244
Relief Valve ..... 265	Fittings - - Grease ..... 243	Loader Nipple ..... 244
Spray Valve ..... 265	Hydraulic ..... 73-86	Needle ..... 244
Depressed Center Wheel ..... 140	Nylon ..... 272-273	Packer ..... 108
Detacher -Chain ..... 167, 169	Pipe ..... 90-91	Pipe-Curved ..... 244
Detent Pins ..... 120	Flail Shredder Components ..... 46	Grinding Wheels ..... 140
Diaphragm - - Hand Pump ..... 246	Flange - - Bolts ..... 146	Guard - - Bolts ..... 34
Check Valve ..... 266	Nuts ..... 150	Buchanan ..... 42-44
Directo Valve ..... 265	Flanges-Bearing ..... 102-105	Kondex ..... 34
Disc - - Abrasive ..... 140	Flashlights & Batteries ..... 139	Milo ..... 47-49
Bearings ..... 92-95, 108	Float Valves ..... 252	Trash - John Deere ..... 45
Sanding ..... 140	Flood - - Jet Nozzles ..... 268	Guide Coulter ..... 11
Drawbar - - Lock ..... 116	Tip Adapter ..... 268	Guns - - Blow ..... 242
Three Point ..... 117	Fuel - - Filter ..... 246	Grease ..... 244
Pins ..... 118	Nozzle ..... 245	Grease Gun Holders ..... 245
Drill - - Bits ..... 130, 132	Furnace Filters ..... 261	Spray ..... 276
Cases ..... 130, 132	G	H
Grinder ..... 130	Gage - - Wheel Bearings ..... 11, 95	Hack Saw - - Blades ..... 127
Driveline Components ..... 173-208	Wheels & Tires ..... 11	Frames ..... 127
Drives Chain ..... 168	Galvanizing Compound ..... 235	Hair Pin Cotters ..... 159
Duct Tape ..... 239	Gasket - - Compound ..... 238	Halogen Lights ..... 230-231
Dust - - Cap ..... 69, 71	Remover ..... 235	Hammers ..... 132
Plug ..... 72, 74	Gasoline - - Filters ..... 246	Hand Gun - Sprayer ..... 276
Dye Bearings ..... 98	Hose ..... 245	Handy Roll ..... 141
	Nozzles ..... 245	Hanger Housing - Bearing ..... 102

## Catalog Index

H (continued)	I	L (continued)
Heat - - Barrier Spray ..... 238	Idler - - Hubs ..... 219	Load Binders ..... 166
Magnet ..... 254	Pulleys ..... 221-222	Lock Nuts ..... 149-150
Pad ..... 254	Sprockets ..... 219-220	Lock Washers ..... 151
Heater - - Battery ..... 254	Implement Chain ..... 170	Locking - - Collars-Eccentric ..... 96
Engine ..... 253-254	Incorporators ..... 9	Hitch Pins ..... 120
Hose ..... 253	Insect Spray ..... 236	Log Chain ..... 166
Tractor Cab ..... 253	Insulators - Electric Fence ..... 250-251	Lubricant - Compounds ..... 235-236
Hex - - Bearings ..... 99	Inverter - Electric Power ..... 233	Chain ..... 169
Bolts ..... 143, 145-147	IPTCI Bearings ..... 99-103	Electrical ..... 233
Keys ..... 155		Wire Rope ..... 162
Nuts ..... 144-145, 149-150	J	Lubricating Graphite ..... 235
Shaft ..... 199	Jacks - - Bull Dog ..... 124	Lynch Pins ..... 118
Hi Lift Jack ..... 125	Farm ..... 123-125	
Hinges ..... 162	G&G ..... 123	M
Hinson - Buggy Top & Umbrella .... 248	Hi-Lift ..... 125	Machine Screws ..... 144-145
Weatherbrakes ..... 255-257	Ratchet ..... 119	Machinery Bushings ..... 152
Hitch - - Balls ..... 125	Jam Nuts ..... 149	Magnetic - - Heater ..... 254
Pins ..... 120-122	Jaw Coupling ..... 210	Light ..... 231
Quick-Speeco ..... 115	J-B Weld ..... 238	Pick-Up Tool ..... 139
Shock ..... 124	Jet Agitator ..... 266	Mail Box ..... 261
Hobbs - Lights ..... 230-231	Journal Assemblies ..... 178-196, 200	Makita Cutting Wheel ..... 140
Hoists-Midwest ..... 62	Jumper Cables ..... 232	Mankato Stroke Control Set ..... 63
Hold Down - - Clips ..... 41		Marking - - Paint ..... 237
Straps ..... 126	K	Pen ..... 141
Hook - - Grab ..... 122, 164-165	Kan-Am Chain Breaker - Parts ..... 167	Mayhew ..... 137-138, 156
Slip ..... 164-165	Kats Engine Heater ..... 253-254	Mean Green Cleaner ..... 238
Hook & Pick Set ..... 137	Keys - - Allen Hex ..... 155	Measuring Wheel-Meter Man ..... 51
Hopper Straps-Grain ..... 51	Cotter ..... 159	Meter Man - Acre Counter ..... 50-51
Hornet Killer ..... 236	Gib ..... 160	Measuring Wheel ..... 51
Hose - - Air ..... 242	Woodruff ..... 158	Metric - Calipers ..... 129
Air Fittings ..... 242	Key Stock ..... 153	Cap Screws ..... 145
Barbs - Nylon ..... 272-273	Keyed Shafting ..... 199	Drive Line Components ..... 182-196
Clamps ..... 253	Klik Pins ..... 118	Hex Nuts ..... 145
Coupling - Hydraulic ..... 67-79	Knifebacks-Kondex ..... 35	Kay Stock ..... 152
Cutter ..... 275	Knife - - Clips-Kondex ..... 33	Washers ..... 145
EVA ..... 274	Utility ..... 127	Zerks ..... 243
Fuel Line ..... 89	Knock 'er Loose ..... 238	Mid Links ..... 122
Gasoline ..... 245	Kondex - - Big Tooth Section ..... 31	Midstates Cultivator ..... 10-11
Grease Gun ..... 244	Lickity Split Repair Kit ..... 31	Midwest - - Harrow Parts ..... 62
Heater ..... 253	Sickle Sections ..... 12-39	Hydraulic Hoists ..... 62
Holder-Hydraulic ..... 88	Kosch - Grass Boards ..... 45	MIG Welding Pliers ..... 134
Hydraulic ..... 88-89	Kovar - - Harrow Teeth ..... 9	Mildew Destroyer ..... 238
PVC ..... 274	Incorporators ..... 9	Miller Hitch Pins ..... 120
Return - Hydraulic ..... 88		Milo Guards ..... 47-49
Sprayer ..... 274	L	Missing Links ..... 164
Suction ..... 88	Lag Screws ..... 143	Mower - End Sections ..... 33
Whip ..... 244	Lap Repair Links ..... 164	Muffler Clamps ..... 246
Hot Pad Heater ..... 254	Layout Fluid ..... 237	
Hour Meter ..... 234	Ledger Plates-Kondex ..... 34	N
Howse Mower U-Joint Kit ..... 181	Lift Arm Parts ..... 117-119	National Oil Seals ..... 111-114
Hub City ..... 63, 173-176	Lights - Flash ..... 139	Neapco ..... 178-196
Hubs - - Caps ..... 61	Safety ..... 231	Needle - Grease Injector ..... 244
Coupler ..... 216	Tractor ..... 230-231	Nipple - - Loader ..... 244
Weld-On ..... 215-216, 222	Warning ..... 231, 233	Pipe ..... 91
Wheel ..... 56-59	Line Strainer ..... 275	Nozzle - - Gasoline ..... 245
Hydraulic - - Adapters ..... 67-72, 81-86	Links - - Implement Chain ..... 170	Tee Jet Spray ..... 266-271
Couplers-Pioneer ..... 67-72	Lap ..... 164	Nuts ..... 144-145, 149-150
Cylinders ..... 64-65	Missing ..... 164	Lock ..... 149-150
Hoist Parts-Midwest ..... 62	Quick ..... 164	Nylon Fittings-Sprayer ..... 272-273
Hose ..... 88-89	Roller Chain ..... 168-171	
Hose Couplings ..... 73-80		
Multiplier ..... 72		
Hypro Pumps ..... 262		

## Catalog Index

N (continued)	P (continued)	R (continued)
Nuts ..... 144-145, 149-150	Polar Starting Fluid ..... 245	Rings - Wheel Reinforcing ..... 61
Lock ..... 149-150	Pressure - - Gauge ..... 263	Rivet - - Buster ..... 137
Nylon Fittings-Sprayer ..... 272-273	Relief Valve ..... 265	Flat Head ..... 170
O	Prince Cylinder Repair Kits ..... 66	Set ..... 137
Offset Links ..... 168-170	Proof Coil Chain ..... 165	Sickle Section ..... 32
Oil - - Cans ..... 245	Pry Bar ..... 138	Tool ..... 41
Cutting ..... 128-129	PTO - - Adapters ..... 173-177	Rockford Hydraulic Cylinders ..... 65
Seals ..... 111-114	Cross Reference ..... 200	Roll Pins ..... 156-157
O Rings ..... 87	Displays ..... 197	Pin Punch ..... 156
Over Running Couplers ..... 174	Shaft ..... 198-199, 202	Roller - - Bearings ..... 106-108
Over Size Load Sign ..... 234	Shields ..... 181, 199	Chain ..... 168-170
P	Pulley - - Cast Iron ..... 223-226	Chain Detacher ..... 169
Packaging Tape ..... 239	Hubs-Double ..... 222	Rope - - Lubricant ..... 162
Paint- - Marker ..... 141	Idler ..... 221-222	Wire ..... 163
Remover ..... 235	Steel ..... 222-223	Row Crop Sweeps ..... 47
Spray On ..... 237	V-Belt ..... 222-226	Rubber Reel Teeth ..... 45
Pans - Utility ..... 245	Weld On ..... 222	Rust Preventative ..... 236
Paper - Sacks ..... 240	Pump - - Ace ..... 263	S
Parmak - - Electric Fencer ..... 249	Adapter ..... 177, 262	Sacks-Paper ..... 240
Warning Light ..... 233	Barrel ..... 244, 246	Safety - - Glasses ..... 129
Parts - - Bags ..... 241	Bearings-Water ..... 11, 95	Light ..... 231
Brush ..... 141	Centrifugal ..... 263	Shield-PTO ..... 181, 199
Bins ..... 240-241	Delevan ..... 263	Warning Reflector Kit ..... 234
Cabinet ..... 241	Diaphragm - Hand ..... 246	Satchel Case ..... 241
Cleaner ..... 237	Hand Pump ..... 244, 246	Sanding - - Discs ..... 140
PB Blaster ..... 238	Hypro ..... 262	Roll ..... 141
Penetrating Oil ..... 236, 238	Oiler ..... 245	Saw - - Blades ..... 126-128
Permatex ..... 238	Sprayer ..... 262-263	Combination-Jack ..... 127
Pick & Hook Set ..... 137	Punch ..... 137-138, 156	Frames ..... 127
Pillow Blocks ..... 97, 103, 105	Pilot ..... 156	Sawzall Blades ..... 126
Pinch Bar ..... 137	PVC - - Hose Cutter ..... 275	Scratch Brush ..... 140
Pins - - Bent ..... 120	Tubing ..... 274	Screw - - Driver ..... 139
Clevis ..... 66, 121, 156	Q	Extractor ..... 130
Coiled ..... 156	Quick - - Couplers-Air ..... 242	Pitch Gauge ..... 129
Corn Picker ..... 156	Couplers-Hydraulic ..... 67-72	Screws - - Cap ..... 145-147, 155
Cotter ..... 159	Hitch-Speeeco ..... 115	Carriage ..... 148
Detent ..... 120	Links ..... 164	Lag ..... 143
Expan ..... 157	Repair Washers ..... 151	Machine ..... 144, 145
Hair ..... 159	Quick Grip Welding Clamp ..... 134	Plow ..... 144
Hitch ..... 120, 122	Quick Stick Marker ..... 141	Set ..... 154-155
Klik ..... 118	Quick Tach Chain ..... 171	Sheet Metal ..... 143
Three Point Linkage ..... 116-119	R	Tek ..... 143
Pintle Chain ..... 172	Radial Bearings ..... 109-110	Seals - - Oil ..... 111-114
Pioneer ..... 67-72	Rags In A Box ..... 239	O-Ring ..... 87
Pipe - - Extractors ..... 130	Rain - - Caps ..... 246	Section - - Kondex ..... 12-40
Fittings ..... 90-91	Gauge ..... 261	Replacement Tool ..... 41
Wrench ..... 134	Rake Teeth-Rubber ..... 45	Rivets ..... 32
Pitman-Wood ..... 33	Rapid Tap Cutting Oil ..... 128	Sickle ..... 12-42
Plastic - - Ties ..... 233	Ratchet - - Jack ..... 119	Set Screws ..... 154-155
Tubing ..... 274	Screwdriver ..... 139	Set Screw Keys ..... 155
Pliers - - Fence ..... 251-252	Redi-Bolt ..... 142	Shaft - - Collars ..... 153, 208
Locking ..... 133-134	Coupler Nut ..... 142	Couplers ..... 209
Multi-Groove ..... 136	Reel Tine-Flexible ..... 35	Keyed ..... 199
Slip Joint ..... 135	Relief Valve ..... 265	PTO ..... 202
Snap Ring ..... 158	Repair - - Lap Links ..... 164	Splined ..... 176-177
Tire Chain ..... 260	Kits - Hydraulic Cylinder ..... 65-66	Shafting ..... 198-199
Vise-Grip ..... 133-134	Washers ..... 151-152	Sheaves - V-Belt ..... 221-226
Welding ..... 134	Retaining Ring Plier ..... 158	Sheet Metal Screws ..... 143
Plow Screws ..... 144		Shield - PTO ..... 181, 199
		Shim - Kondex ..... 33
		Shock Hitch ..... 124

## Catalog Index

S (continued)	S (continued)	T (continued)
Shop - - Cloth ..... 141	Straps - - Hold Down ..... 126	Tubing (continued)
Rags ..... 239	Ratchet ..... 126	Metal Repair ..... 198-199
Shovels-Cultivator ..... 47	Stroke Control Segments ..... 63	Plastic EVA ..... 274
Shredder Components - Flail ..... 46	Suction - - Gun ..... 245	Torque ..... 199
Sickle - - Sections ..... 12-40	Hose ..... 88	Turnbuckles ..... 162
Twin Point ..... 35	Strainer ..... 275	Jack ..... 119
Side - - Chain Fasteners ..... 260	Sun Shade ..... 247-248	Turbo 90 Pump ..... 263
Chain-Tire ..... 260	S/V Tools ..... 41, 167	Twin Point - Sickle Sections ..... 35
Silicon Spray Lubricant ..... 236	Sweeps - - Cultivator ..... 47	Twist Clip ..... 121
Slic-Tite Paste ..... 91	Swivel Adapter-Hydraulic ..... 81-85	Twist Link Chain ..... 260
Slip - - Hooks ..... 164-165	Jacks ..... 123-124	
Plate ..... 235		U
Sleeve ..... 203		Unions - - Pipe ..... 91
Slotted Nuts ..... 150	T	U-Joints ..... 206-207
Slow Moving Vehicle Emblem ..... 234	T Bar Chain ..... 171	Kits-Howse Mower ..... 181
Snap - - Hitch Repair Kit ..... 201-202	Tachometer ..... 234	Repair Kits ..... 181-196, 200
Hitch Yoke ..... 178-196, 204-205	Take-Up Housings - Bearing ..... 102	Umbrellas ..... 247-248
Hitch Adapters .. 175, 177, 204, 262	Talc ..... 235	Utility - - Box ..... 240-241
Rings ..... 158	Tape - - Duct ..... 239	Knife ..... 127
Snips -Tin ..... 136	Electrical ..... 239	Pans ..... 245
Snowco - - Buggy Top ..... 247	Gummed Packaging ..... 239	
Umbrella ..... 247	Measure ..... 136	V
Socket Head - - Cap Screws ..... 155	Strapping ..... 239	V-Belts ..... 227-229
Set Screws ..... 154-155	Thread ..... 91	Pulleys ..... 221-226
Solar Panel ..... 249	Tapered Bearings ..... 106-108	Valves- - Ball ..... 269
Solenoid Valve-Electric ..... 264	Taps -Thread ..... 131-132	Check ..... 266
Speeco - - Quick Hitch ..... 115	Tarps ..... 126	Compression Stop ..... 269
3-Point Conversion ..... 115	Straps ..... 126	Directo ..... 265
3-Point Linkage ..... 115-119	Tee Jet - - Nozzles & Tips ..... 266-271	Float ..... 252
Spindles-Wheel ..... 60	Valves ..... 265	Gate ..... 269
Spinner-Wheel ..... 125	Teeth - - Harrow - Kovar ..... 9	Relief ..... 265
Splined - - Adapter ..... 173-177	Rubber Rake ..... 45	Solenoid-Electric ..... 264
Bore Yoke ..... 204-206	Tek Screws ..... 143	Sprayer Control ..... 264-265
Couplings ..... 173-177	Tep Tape ..... 91	Tee ..... 265
Shaft ..... 176-177	Thermometer-Grain ..... 51	Vehicle Emblems ..... 234
Spray On Products . 129, 162, 169, 223	Thimbles-Wire Rope ..... 163	Lights ..... 230-231, 233
233, 235-237	Thread - Cutting Oil ..... 128-129	Vise Grip Tools ..... 133-134
Sprayer - Cleaner-Golden Rod ..... 242	Gauge ..... 129, 151	
Control Valve ..... 265	Locker Gel ..... 238	W
Fittings-Nylon ..... 272-273	Sealant ..... 91	Wagon Hoists-Midwest ..... 62
Guns ..... 276	Tape ..... 91	Warning - - Light ..... 231, 233
Hose ..... 274	Threaded Rod ..... 142	Reflector Kit ..... 234
Monitor ..... 264	Three Point - - Conversion ..... 115	Washers - - Back Up ..... 87
Nozzles ..... 266-271	Linkage Equipment ..... 115-119	Fender ..... 151
Pumps ..... 262-263	Tie Down - Straps ..... 126	Lock ..... 151
Spreader Conveyor Chain ..... 172	Ties-Plastic ..... 233	Machinery ..... 152
Spring Pins ..... 156-157	Tightener - - Chain ..... 166	Quick Repair ..... 151
Spring - Devil Cultivators ..... 10-11	Tines - - Cultivator ..... 9-10	S.A.E. .... 151
Tooth Harrow-Kovar ..... 9	Flexible Reel ..... 35	Wrought ..... 151
Springs ..... 160-161	Tire - - Cleaner ..... 239	Wasp & Hornet Killer ..... 236
Sprocket - - Aetna ..... 220	Chains ..... 258-259	Water Pump Bearings ..... 11, 95
Coupling ..... 211	Gage Wheel ..... 11	Wear Plate - Kondex ..... 33
Finished Bore ..... 217-218	Tool Box ..... 242	Weather - - Brake ..... 255-257
G & G ..... 211-219, 222	Top Link ..... 116-118	Cap ..... 246
Idler ..... 219-220	Ball Sockets ..... 116	Station ..... 261
Weld-A ..... 212-214	Bushing ..... 116, 118	Weld-A-Bushing ..... 207-208
Stabilizer Kit ..... 119	Pins ..... 117	Weld-A-Hub ..... 215-216
Starting Fluid ..... 245	Repair Ends ..... 116	Weld-A-Joint ..... 206
Stay Strap - 3-Point ..... 119	Tow Chain ..... 165-166	Weld-A-Sprocket ..... 212-214
Stern Hold Down Clip ..... 41	Tractor Chains-Laclede ..... 258-260	Weld-A-Pulley ..... 222
Stove Bolts ..... 144	Trailer - - Hitch Ball ..... 125	
Strainer-Line ..... 275	Trash Guard - John Deere ..... 45	
Strapping Tape ..... 239	Tubing - - Clear PVC ..... 274	

**Catalog Index**

W (continued)

- Weld-On Ball Socket ..... 116-117
- Welding - Clamp ..... 133-134
  - Compound ..... 238
  - Pliers ..... 134
- Wheel - Bearings ..... 105-107
  - Bolts ..... 60-61
  - Bolt Nuts ..... 60-61
  - Gage ..... 11
  - Hubs ..... 56-59
  - Hub Caps ..... 61
  - Reinforcing Rings ..... 61
  - Spindles ..... 60
  - Spinners ..... 125
- Whip Hose ..... 244
- Whiz - Bolts ..... 146
  - Nuts ..... 150
- Wide - Load Signs ..... 234

W (continued)

- Winches ..... 125
- Windbreakers ..... 255-257
- Wing Nuts ..... 150
- Wire - - Brush ..... 140
  - Loom ..... 232
  - Rope Clamps ..... 163
  - Rope-Farm Cable ..... 163
  - Rope Lubricant ..... 162
  - Rope Thimbles ..... 163
  - Stretcher ..... 134, 248
  - Stripper ..... 231
  - Terminals ..... 231-232
- Woodruff Keys ..... 158
- Work Bench - Flambeau ..... 241
- Wrench - - Adjustable ..... 136
  - Chain ..... 134
  - Combination ..... 135

W (continued)

Wrench (continued)

- Pipe ..... 134
- Sets ..... 135
- Vise Grip ..... 133-134
- Wrought Washers ..... 151

Y

- Yokes - PTO ..... 178-197, 202-207
- Yoke & Bar Assemblies ..... 202
- Yoke & Tube Assemblies ..... 202

Z

- Zerk - - Drive In Tool ..... 243
- Grease Fittings ..... 243

DUE TO MARKET CONDITIONS ALL PRICES IN THIS CATALOG ARE SUBJECT TO CHANGE WITHOUT NOTICE.

**CALL 1-800-444-8666 or FAX 1-800-342-5272**

Visit our website at: [www.centralsupplyandrubber.com](http://www.centralsupplyandrubber.com)

**Fraction/Decimal/Metric Chart**

Fraction	Decimal	Millimeter	Fraction	Decimal	Millimeter	Fraction	Decimal	Millimeter	Fraction	Decimal	Millimeter
1/64	.015625	0.397	11/64	.171875	4.366	29/64	.453125	11.509	47/64	.734375	18.653
1/32	.03125	0.794	3/16	.1875	4.763	15/32	.46875	11.906		.7480	19.
	.0394	1.000		.1969	5.		.4724	12.	3/4	.75	19.053
3/64	.046875	1.191	13/64	.203125	5.159	31/64	.484375	12.3b3	49/64	.765625	19.447
1/16	.0625	1.587	7/32	.21875	5.556	1/2	.5	12.700	25/32	.78125	19.844
5/64	.078125	1.984	15/64	.234375	5.953		.5118	13.		.7874	20.
	.0787	2.000		.2362	6.	33/64	.515625	13.097	51/64	.796875	20.241
3/32	.09375	2.381	1/4	.25	6.350	17/32	.53125	13.494	13/16	.8125	20.638
7/64	.109375	2.778	17/64	.265625	6.747	35/64	.546875	13.891		.8268	21.
	.1181	3.000		.2756	7.		.5512	14.	53/64	.828125	21.034
1/8	.125	3.175	9/32	.28125	7.144	9/16	.5625	14.288	27/32	.84375	21.431
1/64	.015625	0.397	19/64	.296875	7.541	37/64	.578125	14.684	55/64	.859-75	21.828
1/3 2	.03125	0.794	5/16	.3125	7.938		.5906	15.		.8661	22.
	.0394	1.		.3150	8.	19/32	.59375	15.081	7/8	.875	22.225
3/64	.046875	1.191	29/64	.328125	8.334	39/64	.609375	15.478	57/64	.890625	22.622
1/16	.0625	1.587	11/32	.34375	8.731	5/8	.625	15.875		.9055	23.
5/6 4	.078125	1.984		.3543	9.		.6299	16.	29/32	.90625	23.019
	.0787	2.	23/64	.359375	9.128	41/64	.640625	16.272	59/64	.921875	23.416
3/32	.09375	2.381	3/8	.375	9.525	21/32	.65625	16.669	15/16	.9375	23.813
7/64	.109375	2.778	25/64	.390625	9.922		.6693	17.		.9449	24.
	.1181	3.		.3937	10.	43/64	.671875	17.066	61/64	.953125	24.209
1/8	.125	3.175	13/32	.40625	10.319	11/16	.6875	17.463	31/32	.96875	24.6
9/6 4	.140625	3.572	27/64	.421875	10.716	45/64	.703125	17.859		.9843	25.
5/3 2	.15625	3.969		.4331	11.		.7087	18.	63/64	.94375	25.003
	.1575	4.	7/16	.4375	11.113	23/32	.71875	18.256	1	1.	25.4



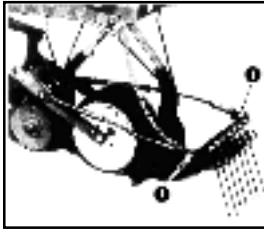

IHC - 27" CABLES - 15" WIDE  
 WHITE - 33" CABLES - 15" WIDE  
 LIFT CHAINS FASTEN TO #1 ABOVE

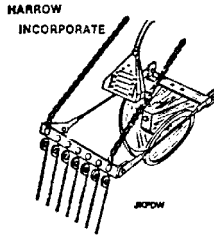

MARROW INCORPORATE  
 JD 7000 - 7100 PLANTER

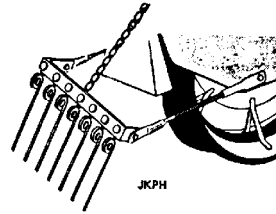

JKPH  
 DESIGNED TO FIT MOST PLANTERS  
 17" CABLES - 12" WIDE

## KOVAR PLANTER INCORPORATOR

### DESIGNED TO FIT MOST PLANTERS

1/2" cables allow teeth to follow contour without digging in. Spring teeth allow mixing action in the field. Chain lift depth control and transporting. All cables have a "Fiber Core Center". This lets you put pressure on teeth. All bolts and chains plated.

Model	Type	Color	Wt.	Price
JKWHI .....	For Older White 5100, 33" Cables, 15" Wide .....	Red .....	7 lbs. ....	\$39.00
JKINC72 .....	Repair Teeth .....			1.20

### REPAIR PARTS - DEERE

JKCAD .....	Cable Complete .....			9.50
JKLCD .....	Lift Chain .....			1.95
JKEBD .....	Eye Bolt w/nut .....			.85

*Centralize with Central*  
 Call Toll-Free:  
**1-800-444-8666**  
 or Fax Toll-Free:  
**1-800-342-7252**



## KOVAR SPIKE TEETH & PARTS

### SPIKE TEETH

Heat Treated - - - 5/8" x 7/8" Diamond

Model	Type	Price
JKSP8 .....	7/16" x 2" Neck For Regular 1-3/8" Tube .....	\$4.20
JKSP8L ...	7/16" x 2-1/2" Neck Where Clamp Is OnTube .	5.00
JKSP9 .....	1/2" x 2-1/4" Neck for Heavy Duty 1-5/8"Tube .	4.20
JKSP9L ...	1/2" x 2-3/4" Neck Where Clamp Is OnTube ...	5.00

DEALER SCHEDULE.....102

ALL ARE PRICES SUBJECT TO CHANGE WITHOUT NOTICE!

You Can *Rely* On  
*Central Supply!*

Over 95% Of All Orders Ship The Same Day!



# Spring Devil CULTIVATOR

1978 And After



ASSEMBLY DIAGRAM FOR  
SPRING TINE CULTIVATOR

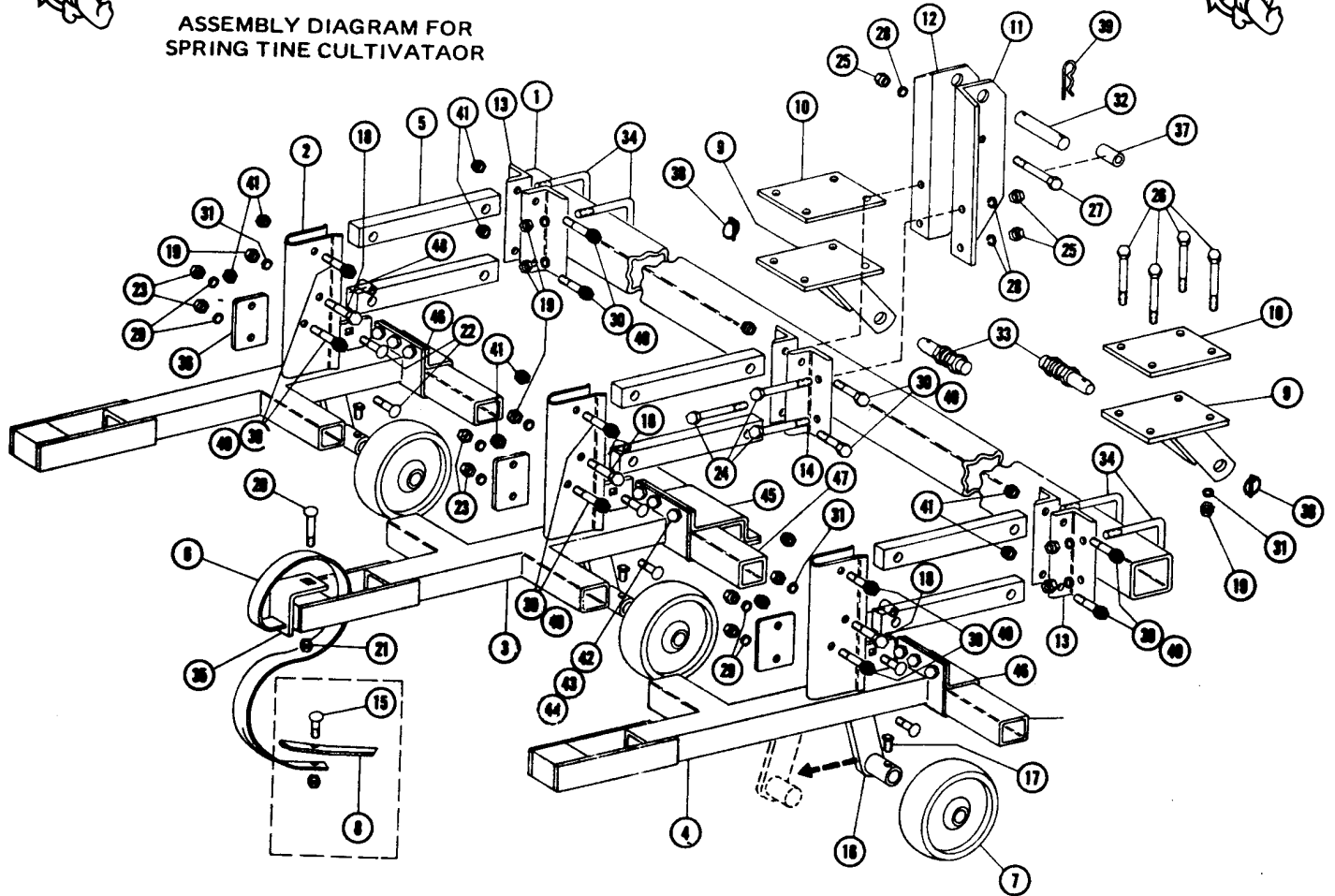

PLEASE NOTE: BEFORE MOUNTING STABILIZER COULTER  
REVERSE GAUGE WHEEL BRACKET TO REAR (SOLID ARROW)

No.	Ref.	Description	Quantity Required Per Model				Price
			C-2A	C-4A	C-6-30A C-6-40A	C-8-30A C-8-30A-H	
SD-03	3	Center Gang	1	3	5	7	\$117.39
SD-13	13	Outside Mounting Angle (Threaded)	2	4	6	8	10.45
SD-13A	13A	Outside Mounting Angle (No Threads)	2	4	6	8	9.87
SD-14	14	Center Mounting Angle (Threaded)	1	1	1	1	12.18
SD-14A	14A	Center Mounting Angle (No Threads)	1	1	1	1	11.50
SD-16	16	Gauge Wheel Bracket	3	5	7	9	13.86
SD-20	20	7/16"x3-1/4" Carriage Bolt	11	21	31	41	1.05
SD-30	30	Adjustment Bolt (7/8" S.A.E.)	12	20	28	36	6.72
SD-34	34	U-Clamp (5/8") Plated	4	8	12	16	4.99
SD-35	35	Tine Clamp	11	21	31	41	3.26
SD-36	36	Hold Plate	3	5	7	9	2.84
SD-45	45	Center Front Bar Clamp	1	3	5	7	9.87
SD-48	48	1"x1" Bushing (Prior to 1980)					2.42
SD-49	49	U-Clamp (3/4") For Hitch Pin Bracket					8.82



# Spring Devil CULTIVATOR



## SPRING LOADED GUIDE COULTER ASSEMBLY

Part No.	Ref.	Description	Qty.	Price
SD-COL001	6	Collar with Set Screw	4	\$2.00
SD-SHUA001	13	Hub Assembly (Complete)	1	59.22
SD-SPC001		Spacer	2	1.42
SD-SAXL001		Axle (3/4"x8")	1	4.73

## STANDARD RIGID GUIDE COULTER ASSEMBLY

Part No.	Ref.	Description	Qty.	Price
SD-SPC001		Spacer	4	\$1.42

## SDGW GAUGE WHEEL WITH 15 INCH RIM

Part No.	Ref.	Description	Qty.	Price
SD-HUB002	9	Hub w/Inner & Outer Bearing Cup Pressed In	1	\$32.76
SD-DCA001	14	Dust Cap	1	1.94

Dealer Schedule.....102

ALL PRICES ARE SUBJECT TO CHANGE WITHOUT NOTICE

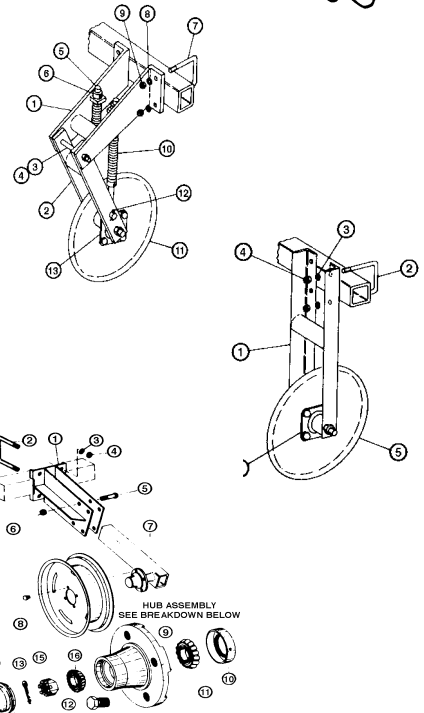

## CULTIVATOR GAGE WHEELS, TIRES, AND BEARINGS

### SMOOTH CROWN GAGE TIRE (4" X 12")

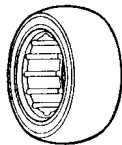

### GAGE WHEEL HALF (4" X 12") (Sold In Pairs Only)



No.	Description	Each
4005-17	4" x 12" Smooth Cultivator Gage Tire	\$21.50

Order No.	Description	Pair
GW412-10-2	Standard White 4" x 12" Gage Wheel Half. Center Hole Extruded for No. 885154B and No. 203001	
	Water Pump Bearing	\$16.00

Dealer Schedule.....152

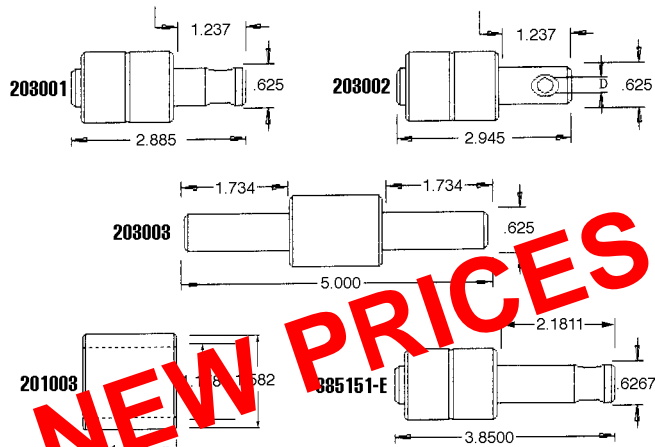

## GAGE WHEEL/WATER PUMP BEARINGS

No.	Description	Price
203001	(885154B) Water Pump Bearing with under-cut shaft. For A.C., J.D, MF, Nobel and Spring Devil	\$18.93
203002	(1B0732RSP) Water Pump Bearing with Cross-Hole. For J.D. & Kinze	20.52
201003	Powdered Metal Sleeve for 4x16 gage wheel, fits 203001 & 203002 Brgs.	2.88
203003	(885151B0S2) Water Pump Bearing with Double End Shaft. for Noble H.D. and Lilliston	20.08
885151-E	IHC #526769R91 Water Pump Brg. with Long Shaft	20.52

Dealer Schedule.....152

NEW PRICES AS OF 4/15/2020

(NOTE: FOR AGCO-GLEANER, SEE DEUTZ-ALLIS)

**KONDEX**

**CASE/IH**

(Formerly IHC)

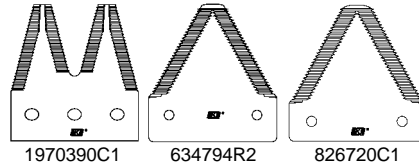

**SICKLE SECTIONS**

Order No.	Replacement For OEM No.	Section Size	Section Type	Section Thickness	Section Finish	Machine	Rivet Size
211-003	826723C1	Shape #2	US	R		Mowers,	9/16 OH
212-063	457606R2	Shape #2	US	R	PL	Mower/Conditioners,	9/16 OH
211-011	826724C1	Shape #2	SM	XH		Windrowers	5/8 OH
212-131	457605R2	Shape #2	SM	XH	PL		5/8 OH
211-001	826722C1	Shape #2	US	XH			5/8 OH
212-061	457607R2	Shape #2	US	XH	PL		5/8 OH
211-211	826720C2	Shape #2	TS	XH			5/8 OH
212-001	596321R3, 700705300	Shape #2	TS	XH	PL		5/8 OH
<b>NOTE: M22831 - Order 211-001, ME333 - Order 211-003, M333-1/2 - Order 211-011</b>							
612-140	148200C1	End Section	TS	XH	PL	Right Hand - 2 Hole	5/8 OH
612-050	700705463	End Section	TS	XH	PL	Right Hand - 3 Hole	5/8 OH
612-090	700705462	End Section	TS	XH	PL	Left Hand - 3 Hole	5/8 OH
411-091	634793R2	Shape #10	TS	XH		Combines <b>except</b> H-C Header and #820 Floating Header	5/8 OH
412-071	634794R2	Shape #10	TS	XH	PL		5/8 OH
112-001	179736C2	Shape #9	TS	XH	PL	Combines w/H-C Floating Bar	5/8 CTSK
211-211	826720C2	Shape #2	TS	XH		820 Header, 1010, 1020 w/3" Cut ( 2 Holes)	5/8 OH
622-251	1970390C1, 1305239C1	Twin Point	TS	XH	PL	1010, 1020 w/1-1/2" Cut ( 3 Slotted Holes)	Bolt w/Oval Neck

Note: For Overlap Sections see page 34

**SICKLE ASSEMBLIES**

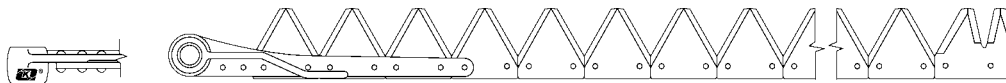

**Mowers, Series "100", Balanced Head, New Idea #521, 522, Ford #505, Case/IH #1100, 1300**

Bolt-On Order No.	Riveted Order No.	Replacement For OEM No.	Sickle Length	Number Of Sections	OEM Section Part Number	Type Of Section	Rivet Size	OEM Head Number
	800-066	462380R93	7 FT.	28	826722C1	XH US	5/8 OH	56692C91
	800-067	463159R93	9 FT.	36	826722C1	XH US	5/8 OH	56692C91



**Combines #810 Floating Header, Serial #19000 and below (H-C GEN I)**

Bolt-On Order No.	Riveted Order No.	Replacement For OEM No.	Sickle Length	Number Of Sections	OEM Section Part Number	Type Of Section	Rivet Size	OEM Head Number
	800-325	179761C92	13 FT.	52	179736C2	XH TS PL	5/8 CTSK	179765C1

Continued On Next Page. See Page 36-37 For Abbreviation Explanations. See Page 39 For Complete Price List.

(NOTE: Items not shown are available on a special order basis, Non-Stock Dealer Schedule - 202 F.O.B. Factory) Copyright 1994 Kondex

**KONDEX  
SICKLE ASSEMBLIES**

**CASE/IH**  
(Formerly IHC)

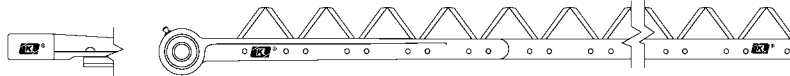

**Combines #810 Floating Header, Serial #26001 and above (H-C GEN III)**

Bolt-On Order No.	Riveted Order No.	Replacement For OEM No.	Sickle Length	Number Of Sections	OEM Section Part Number	Type Of Section	Rivet Size	OEM Head Number
800-127	180853C92	180853C92	13 FT.	52	179736C2	XH TS PL	5/8 CTSK	180859C91
800-131	180857C92	180857C92	20 FT.	80	179736C2	XH TS PL	5/8 CTSK	180859C91

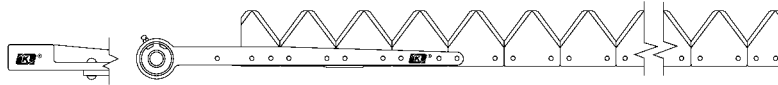

**Combines/Model 810 Header, Non-Floating Bar**

Bolt-On Order No.	Riveted Order No.	Replacement For OEM No.	Sickle Length	Number Of Sections	OEM Section Part Number	Type Of Section	Rivet Size	OEM Head Number
800-425	176718C92	176718C92	15 FT.	58	634794R2	XH TS PL	5/8 OH	178466C91

Continued On Next Page. See Page 36-37 For Abbreviation Explanations. See Page 39 For Complete Price List.

(NOTE: Items not shown are available on a special order basis, Non-Stock Dealer Schedule - 202 F.O.B. Factory) Copyright 1994 Kondex

***You Can Rely On  
Central Supply!  
Call: 1-800-444-8666***

***Centralize  
with  
Central Supply!***

**Call Toll-Free  
1-800-444-8666  
Fax Toll-Free  
1-800-342-7252**

# CASE/IH

(Formerly IHC)

# KONDEX

## MISCELLANEOUS ITEMS

Order No.	Replacement For OEM No.	Description	Machine
901-041	197230C91	Sickle Head	Combine/Model 830
920-223	176699C91	Bearing	Models 810, 820
529-056	MC468 179759C1	Wear Plate	All Mowers, Windrowers, Combines
920-126	455634R1 MA990	Ledger Plate	Mowers
920-127	MA330	Outer Shoe Plate	Mowers
920-343	458965R1	Inner Shoe Plate	Mowers
920-128	MA1577	Pitman Strap (front)	Mowers
920-129	M1578	Pitman Strap (rear)	Mowers
901-012	MA999	Sickle Head	Mowers
920-130	458971R1	Bronze Bushing	
920-136	458972R1	Head Plug	
920-314	458973R4	Knifehead Pin	
901-042	824594C91	Sickle Head	Windrowers #4000, 5000
920-146	MC465	Inner Sole	Mowers
920-152	M22184	Pitman Wood	Mowers

## MISCELLANEOUS ITEMS

Order No.	Replacement For OEM No.	Description	Machine
920-159	MB22863	Head Wear Plate	Mowers
515-046	MA812	Malleable Low Knife Clip for Riveted Sickles Only	All Mowers
515-026	MB812	Malleable High Knife Clip for Riveted Sickles Only	All Mowers
515-126	611759R1 595648R1	Extra High for Knifehead Area for Bolted or Riveted Sickles	Mower/Conditioners  Windrowers
515-016	179757C1	Low Knife Clip	Floating Headers Gen II & III H-C
515-066	176722C1 544274R1	Low Knife Clip for Bolted or Riveted Sickles	Mower/Conditioner Windrowers Combines/820
515-116	613842R2 1307280C1	Low Knife Clip for Bolted or Riveted Sickles	810 Header - Non-Floating
904-526	1970505C1 1970507C1	17/32" Bolt & Nut (50 pcs.)	#1010, 1020 Headers (TJ50BN)
904-527	1970506C1	1-1/8" Bolt & Nut (25 pcs.)	#1010, 1020 Headers (TJ60BN)

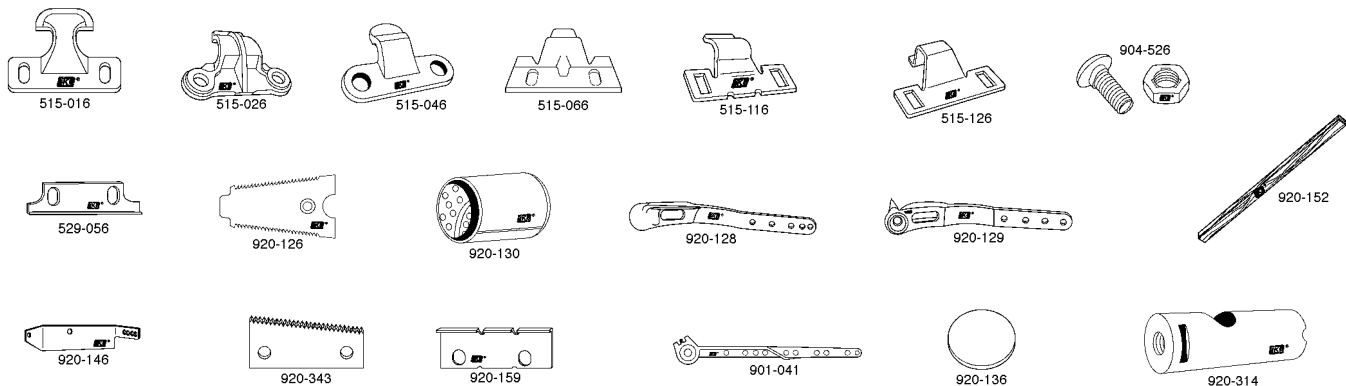

Continued On Next Page. See Page 36-37 For Abbreviation Explanations. See Page 39 For Complete Price List.

(NOTE: Items not shown are available on a special order basis, Non-Stock Dealer Schedule - 202 F.O.B. Factory) Copyright 1994 Kondex

*Centralize  
with  
Central Supply!*

**Call Toll-Free  
1-800-444-8666  
Fax Toll-Free  
1-800-342-7252**

# KONDEX

# JOHN DEERE

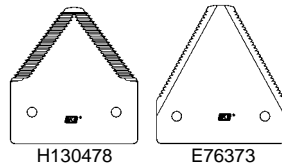

## SICKLE SECTIONS

Order No.	Replacement For OEM No.	Section Size	Section Type	Section Thickness	Section Finish	Machine	Rivet Size
211-203	Z7029H	Shape #1	US	R		All Mowers,	9/16 OH
212-073	H21529	Shape #1	US	R	PL		9/16 OH
211-102	Z6451H	Shape #1	SM	H		Mower/ Conditioners	9/16 OH
212-152	H21525	Shape #1	SM	H	PL		9/16 OH
211-022	Z7030H	Shape #1	US	H		Windrowers	9/16 OH
212-082	H21530	Shape #1	US	H	PL		9/16 OH
212-242	E45996	Shape #1	TS	H	PL		9/16 OH
211-021	E76373	Shape #1	US	XH		Dura Cut replacement	5/8 OH
212-081	E76371	Shape #1	US	XH	PL	Dura Cut replacement	5/8 OH
212-241	E76370	Shape #1	TS	XH	PL	Dura Cut replacement	5/8 OH

**NOTE: For Overlap Sections for #300 Drive, see page 34**

211-223	W30344	Shape #3	US	R		Windrower #580, 590	9/16 OH
411-042	P49650	3"x3-1/4"	TS	H		Combines #30-105	1/4x5/8 OH
412-042	H21527, E130477	3"x3-1/4"	TS	H	PL		1/4x5/8 OH
411-022	H84413	Shape #13	TS	H		Combines #3300-8820	5/8 OH
412-022	H84415	Shape #13	TS	H	PL		5/8 OH
412-021	H130478	Shape #13	TS	XH	PL	Dura Cut replacement	5/8 OH
412-001	H125893	Shape #13	TS (CTSK)	XH	PL	#900 Series Headers	5/8 Bolt
412-321	H136807	Shape #13	TS (CTSK)	XH	PL	Dura-Lite Replacement	5/8 Bolt
612-220	H81499	Half Section				Combines #3300-8820	5/8 OH

## SICKLE ASSEMBLIES

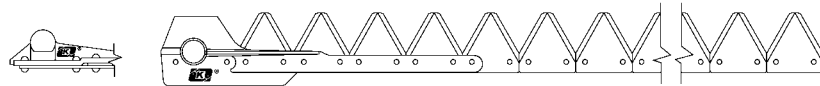

### Mowers #5, 8, 9, 11, 37, 38, 39, 39N

Bolt-On Order No.	Riveted Order No.	Replacement For OEM No.	Sickle Length	Number Of Sections	OEM Section Part Number	Type Of Section	Rivet Size	OEM Head Number
	800-292	AZ958H	7 FT.	28	Z6451H	H SM	9/16 OH	H28076H
	800-294	AZ1299H	7 FT.	28	Z7030H	H US	9/16 OH	H28076H
	800-296	AZ3987H	9 FT.	36	Z6451H	H SM	9/16 OH	H28076H
	800-298	AZ3988H	9 FT.	36	Z7030H	H US	9/16 OH	H28076H

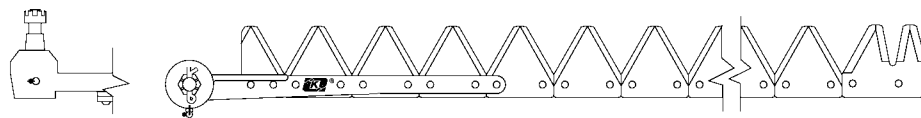

### Mower/Conditioner #1209 up to S/N 285000 (9'), 480, 483, 485 (9'), 1214 (12'+14')

### Windrowers #780, 800, 830, 880, 2250, 2270 (12'-21') Platforms #88, 120, 188, 220

Bolt-On Order No.	Riveted Order No.	Replacement For OEM No.	Sickle Length	Number Of Sections	OEM Section Part Number	Type Of Section	Rivet Size	OEM Head Number
	800-282	AE28073	14 FT.	56	E45996	H TS PL	9/16 OH	AE24247

Continued On Next Page. See Page 36-37 For Abbreviation Explanations. See Page 39 For Complete Price List.

(NOTE: Items not shown are available on a special order basis, Non-Stock Dealer Schedule - 202 F.O.B. Factory) Copyright 1994 Kondex

# JOHN DEERE

# KONDEX

## SICKLE ASSEMBLIES

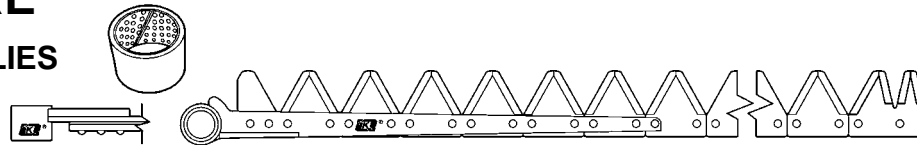

Mower/Conditioners #1209 after S/N 285001, 1217 (7'), 1219 (9'), Mid-Pivot #1380, 1424 (12'+14'),  
Windrowers #2280, 2320, 2420, Auger Platforms #230, 240 (12', 14', 16'),  
Draper Platforms #130, 135 (15', 18', 21', 25')

Bolt-On Order No.	Riveted Order No.	Replacement For OEM No.	Sickle Length	Number Of Sections	OEM Section Part Number	Type Of Section	Rivet Size	OEM Head Number
	800-387	AE35846	16 FT.	64	E76370	XH TS PL	5/8 OH	AE47798

**NOTE: Head #AE47798 Replaces #AE34328**

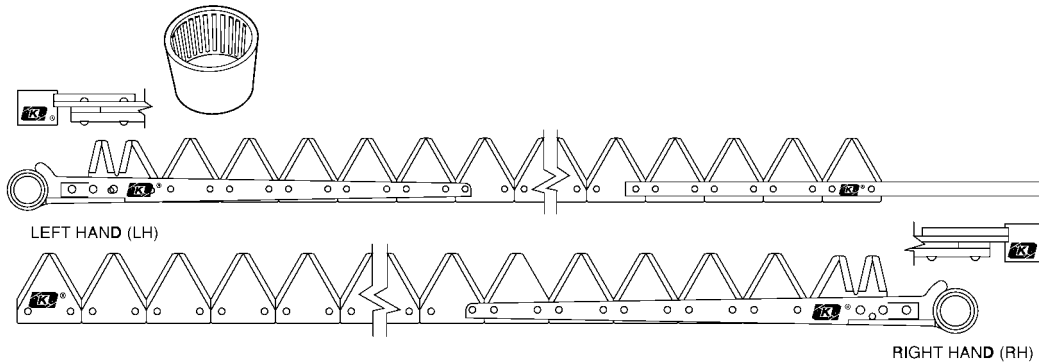

Mower/Conditioners #1525 with #300 Twin Knife Drive & 1600 Mower/Conditioner prior to S/N 880,001, Platform (12', 14'),  
Windrowers #3430, 3830 with #300 Twin Knife Drive (12'-16') prior to S/N 880,000.

Bolt-On Order No.	Riveted Order No.	Replacement For OEM No.	Sickle Length	Number Of Sections	OEM Section Part Number	Type Of Section	Rivet Size	OEM Head Number
801-590		AE48134 (RH)	8 FT. (AE43510)	31	E76370	XH TS PL	9/16 OH	AE48126
801-591		AE48130 (LH)	8 FT. (AE43519)	32	E76370	XH TS PL	9/16 OH	AE48125

**NOTE: Above sickles have new knifehead with NEEDLE BEARING and must be used with knifehead pin #920-378 (E77840)**

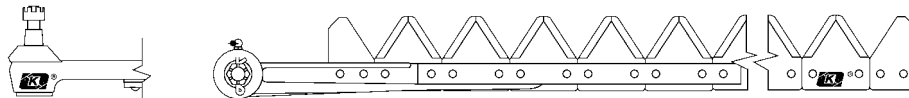

Combines, 200 SERIES HEADERS #3300, 4400, 4420, 6600, 6620, 7700, 7720, 8820 Platforms #213-230

Bolt-On Order No.	Riveted Order No.	Replacement For OEM No.	Sickle Length	Number Of Sections	OEM Section Part Number	Type Of Section	Rivet Size	OEM Head Number
	800-312	AH125751(215)	15 FT.	58	H130478	XH TS PL	5/8 OH	AH89498
801-314	800-314	AH125753(218)	18 FT.	70	H130478	XH TS PL	5/8 OH	AH89498

**NOTE: For AH88845, order #800-312. For AH88846, order #800-313. For AH88847, order #800-314. For AH88848, order #800-315**

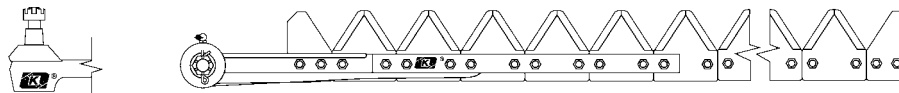

Combines, 900 SERIES HEADERS, #9400, 9500, 9600

Bolt-On Order No.	Riveted Order No.	Replacement For OEM No.	Sickle Length	Number Of Sections	OEM Section Part Number	Type Of Section	Bolt Length	OEM Head Number
801-314	N/A	AH121079(918)	18 FT.	70	H125893	XH TS PL	5/8 Bolt	AH121075

Continued On Next Page. See Page 36-37 For Abbreviation Explanations. See Page 39 For Complete Price List.

(NOTE: Items not shown are available on a special order basis, Non-Stock Dealer Schedule - 202 F.O.B. Factory) Copyright 1994 Kondex



# KONDEX

# JOHN DEERE

## MISCELLANEOUS ITEMS

Order No.	Replacement For OEM No.	Description	Machine
901-036	H28076H	Sickle Head	Mowers
901-039	AE24247	Sickle Head	Mower/Conditioner Windrower (Older)
920-332	H62221	Knifehead Pin	
920-333	E57632	Bushing	
920-334	E78721	Seal	
920-379	AE48137	Needle Bearing	
901-044	AH89498 AH121075	Sickle Head	Combine/200 Series Combine/900 Series
920-119	Z5110H	Ledger Plate	Most Mowers
920-144	H24076H	Inner Sole	Mowers
529-056	E47954 H101200 H84414	Wear Plate-6"	Mower, Mower/Conditioner Windrowers, Combines

## MISCELLANEOUS ITEMS

Order No.	Replacement For OEM No.	Description	Machine
920-154	H28286	Pitman Wood -37"	Mower #8W, 9W
920-155	Z9298H	Pitman Wood -34"	Mower #5
920-329	Z9913H	Pitman Wood -27"	Mower #8, 9
920-193	Z6010H	Front Guide	Mowers
515-006	E47955	Low Knife Clip for Riveted Sickles	Mowers Mower/Conditioner
515-066	E47955	Low Knife Clip for Riveted or Bolted Sickles	Mower/Conditioner Windrowers
515-116	H84412 H127081	Low Knife Clip for Riveted or Bolted Sickles	Combines
904-500	H125891 H125892	Section Bolt (50 pcs.) Section Nut (50 pcs.)	Combines with #900 Series Headers
904-504	H125889	Head Bolt & Nut (25 pcs.)	

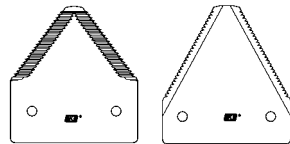
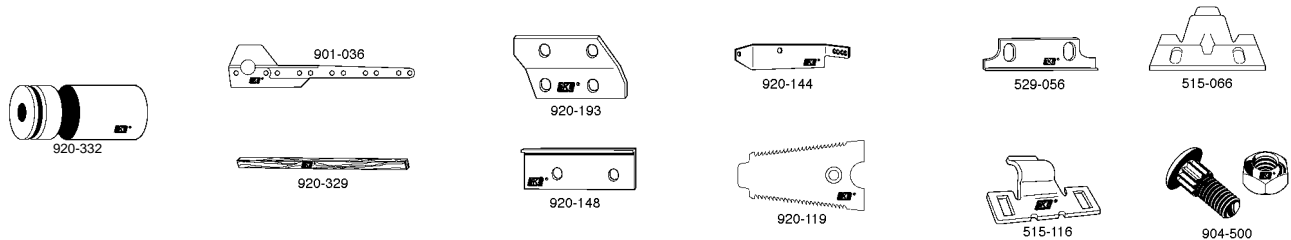

## DEUTZ-ALLIS (Formerly Allis-Chalmers)

71353125      70802541

## SICKLE SECTIONS

Order No.	Replacement For OEM No.	Section Size	Section Type	Section Thickness	Section Finish	Machine	Rivet Size
211-102	70802535	Shape #1	SM	H		All Mowers,	9/16 OH
211-022	70802541	Shape #1	US	H			9/16 OH
422-003	71122784	Shape #14	TS	R	PL	"Gleaner"	9/16 OH
412-051	71135135	Shape #14	TS	XH	PL	Series 3 Header	5/8 OH
411-051	71351135(CTSK)	Shape #14	TS	XH			5/8 Bolt
412-061	71348175(CTSK)	Shape #14	TS	XH	PL		5/8 Bolt
112-001	71176531	Shape #9	TS	XH	PL	Combine Floating Bar - Hart-Carter	5/8 CTSK
612-173	71122802	Half Section	SM	R	PL	"Gleaner"	9/16 OH
622-041	71353125	Twin Pt. Shape #8	TS	XH		All D-A "Clean-Cut"	5/8 Bolt

Continued On Next Page.      See Page 36-37 For Abbreviation Explanations.      See Page 39 For Complete Price List.

(NOTE: Items not shown are available on a special order basis, Non-Stock Dealer Schedule - 202 F.O.B. Factory) Copyright 1994 Kondex

# DEUTZ-ALLIS

(Formerly Allis-Chalmers)

# KONDEX

## SICKLE ASSEMBLIES

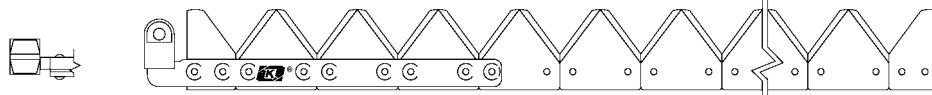

### Combines #A, C, E, F, G, K, L, M, F2, K2, L2, M2 "Gleaner"

Bolt-On Order No.	Riveted Order No.	Replacement For OEM No.	Sickle Length	Number Of Sections	OEM Section Part Number	Type Of Section	Rivet Size	OEM Head Number
	800-221	71188415	15 FT.	59	71122784	R TS PL	9/16 OH	71351136
	800-224	71188420	20 FT.	79	71122784	R TS PL	9/16 OH	71351136
	800-225	71188422	22 FT.	87	71122784	R TS PL	9/16 OH	71351136
	800-226	71188424	24 FT.	95	71122784	R TS PL	9/16 OH	71351136
	800-229	71188313	13 FT.	51	71135135	XH TS PL	5/8 OH	71351136
	800-231	71188315	15 FT.	59	71135135	XH TS PL	5/8 OH	71351136
	800-232	71188316	16 FT.	63	71135135	XH TS PL	5/8 OH	71351136
	800-233	71188318	18 FT.	71	71135135	XH TS PL	5/8 OH	71351136
801-234	800-234	71188320	20 FT.	79	71135135	XH TS PL	5/8 OH	71351136
	800-235	71188322	22 FT.	87	71135135	XH TS PL	5/8 OH	71351136
	800-236	71188324	24 FT.	95	71135135	XH TS PL	5/8 OH	71351136

**NOTE:** Above sickles have new 9-hole knifehead.

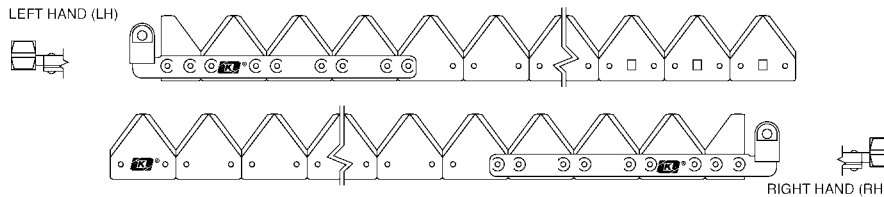

### Combines "Gleaner" N Series, Double Sickles

Bolt-On Order No.	Riveted Order No.	Replacement For OEM No.	Sickle Length	Number Of Sections	OEM Section Part Number	Type Of Section	Rivet Size	OEM Head Number
	800-637	71316139(LH)	10 FT.	36	71122784	R TS PL	9/16 OH	71186226

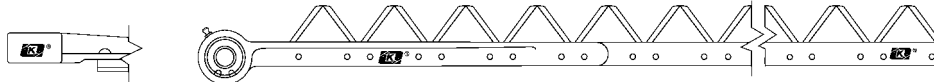

### Combines Floating Cutter Bars, Hart-Carter Generation III, Series 2

Bolt-On Order No.	Riveted Order No.	Replacement For OEM No.	Sickle Length	Number Of Sections	OEM Section Part Number	Type Of Section	Rivet Size	OEM Head Number
	800-134	71307333	13 FT.	53	71176531	XH TS PL	5/8 CTSK	71307323
	800-136	71307335	16 FT.	65	71176531	XH TS PL	5/8 CTSK	71307323

**NOTE:** These sickles are ONE section longer than Hart-Carter sickles, so for D-A headers, only order above part numbers.

Continued On Next Page. See Page 36-37 For Abbreviation Explanations. See Page 39 For Complete Price List.

(NOTE: Items not shown are available on a special order basis, Non-Stock Dealer Schedule - 202 F.O.B. Factory) Copyright 1994 Kondex

**Centralize with Central Supply & Rubber Co.**  
**Our Representatives Receive Full Credit On All Phone & Fax Orders!**

# DEUTZ-ALLIS

(Formerly Allis-Chalmers)

# KONDEX

## SICKLE ASSEMBLIES

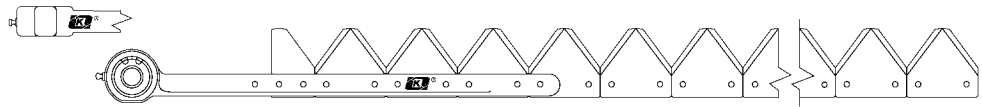

### Combines Flex Cutter Bars - Series 3 Flexhead (13" - 20') Series 300 Rigid Head (20' - 30') (1984)

Bolt-On Order No.	Riveted Order No.	Replacement For OEM No.	Sickle Length	Number Of Sections	OEM Section Part Number	Type Of Section	Rivet Size	OEM Head Number
	800-514	71328414	20 FT.	79	71135135	XH TS PL	5/8 OH	71315990

NOTE: For Bolts & Nuts, see page 34

## MISCELLANEOUS ITEMS

Order No.	Replacement For OEM No.	Description	Machine
901-025	71351136	Sickle Head	"Gleaner" Combines
901-118	71342809	Sickle Head	Series 3 Headers (Newer)
901-016	71307323	Sickle Head	Series 2 Headers
529-056	71116532 71176537	Wear Plate	All Combines
515-116	71189684 71346158	Low Knife Clip for Bolted or Riveted Sickles	All Combines Except Hart-Carter Floating Headers
515-016	71176540	Low Knife Clip	Hart-Carter Floating Header Only

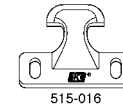
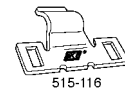
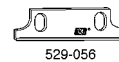
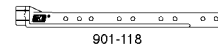

## KONDEX

## FORD

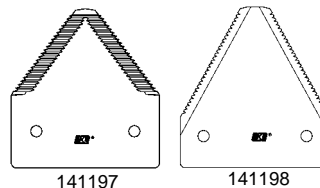

### SICKLE SECTIONS

Order No.	Replacement For OEM No.	Section Size	Section Type	Section Thickness	Section Finish	Machine	Rivet Size
211-203	141113	Shape #1	US	R		Mower	9/16 OH
211-102	141197	Shape #1	SM	H			9/16 OH
211-022	141198	Shape #1	US	H			9/16 OH

Continued On Next Page.      See Page 36-37 For Abbreviation Explanations.      See Page 39 For Complete Price List.

(NOTE: Items not shown are available on a special order basis, Non-Stock Dealer Schedule - 202 F.O.B. Factory) Copyright 1994 Kondex

**Call 1-800-444-8666**

# KONDEX

# FORD

## MISCELLANEOUS ITEMS

Order No.	Replacement For OEM No.	Description	Machine
901-071	142670	Sickle Head	Mowers #14-15
529-056	141021 242046	Wear Plate	Mowers
920-151	149198	Pitman Wood - 46"	Mowers, all current models
515-036	142726	Low Knife Clip for Riveted Sickles Only	Mowers
515-026	141008	High Knife Clip	Mowers
920-128	143575	Pitman Strap (front)	Mowers
920-129	143576	Pitman Strap (rear)	Mowers
920-118	142570	Ledger Plate	Mowers

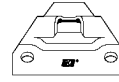

515-036

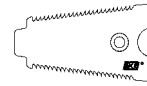

920-118



515-026



515-026

## FORD NEW HOLLAND

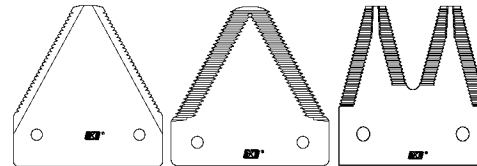

29875

9622744

848093

### SICKLE SECTIONS

Order No.	Replacement For OEM No.	Section Size	Section Type	Section Thickness	Section Finish	Machine	Rivet Size
211-003	67630	Shape #2	US	R		Mowers,	9/16 OH
212-063	604800	Shape #2	US	R	PL	Mower/	9/16 OH
212-003	604921	Shape #2	TS	R	PL	Conditioners	9/16 OH
212-012	604921H	Shape #2	TS	H	PL	Windrowers	9/16 OH
211-211	TS29875	Shape #2	TS	XH			
211-011	26622	Shape #2	SM	XH			5/8 OH
211-001	29875	Shape #2	US	XH			5/8 OH
212-061	706226	Shape #2	US	XH	PL		5/8 OH
212-262	706424	Overlap	TS	H	PL	(CTSK) Bottom 10/box	5/8 CTSK
<b>NOTE: For Overlap Sections on cards see page 34</b>							
412-021	134104	Shape #13	TS	XH	PL	Combines w/Rigid Headers	5/8 OH
211-261	271981	Shape #11	TS	XH		Combines w/J.E. Love	5/8 CTSK
212-121	271981CR	Shape #11	TS	XH	PL	Floating Headers	5/8 CTSK
622-031	848093	Twin Point (7)	TS	XH	PL	Combines w/Twin Cut	5/8 Bolt

Continued On Next Page. See Page 36-37 For Abbreviation Explanations. See Page 39 For Complete Price List.

(NOTE: Items not shown are available on a special order basis, Non-Stock Dealer Schedule - 202 F.O.B. Factory) Copyright 1994 Kondex

# Fax 1-800-342-7252

DUE TO MARKET CONDITIONS ALL PRICES ARE SUBJECT TO CHANGE WITHOUT NOTICE!

# KONDEX

# FORD NEW HOLLAND

## SICKLE ASSEMBLIES

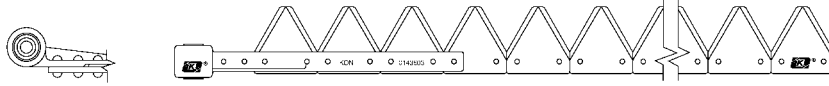

### Mowers #451, 456

Bolt-On Order No.	Riveted Order No.	Replacement For OEM No.	Sickle Length	Number Of Sections	OEM Section Part Number	Type Of Section	Rivet Size	OEM Head Number
	800-362	228435	7 FT.	29	29875	XH US	5/8 OH	143603
	800-363	228434	9 FT.	35	29875	XH US	5/8 OH	143603

NOTE: For Ford N-H #858744, Order 801-362 For Ford N-H #858745, Order 801-363

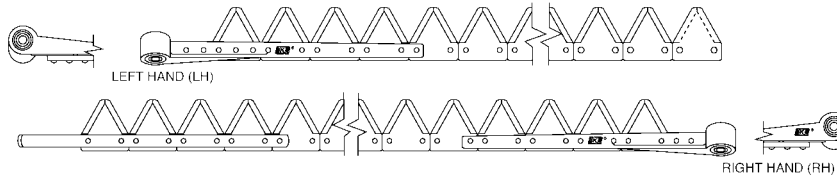

### Windrower #907, 909, 910, 912

Bolt-On Order No.	Riveted Order No.	Replacement For OEM No.	Sickle Length	Number Of Sections	OEM Section Part Number	Type Of Section	Rivet Size	OEM Head Number
801-012		TS139185(LH)	7 FT.	25	604921H	H TS PL	9/16 OH	135822
	800-015	139184(RH)	7 FT.	27	604800	R US PL	9/16 OH	137635
	800-016	139185(LH)	7 FT.	25	604800	R US PL	9/16 OH	135822

## SICKLE ASSEMBLIES

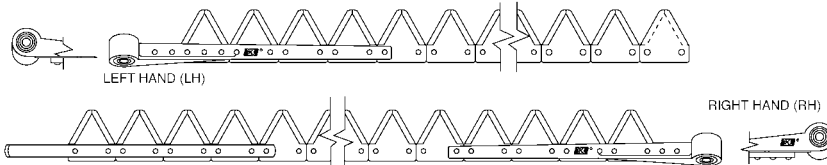

### Windrowers #1100 w/High Perform Header, 1112, 1114, 1116, 1118, 116 (14'+16') Pivot Tongue

Bolt-On Order No.	Riveted Order No.	Replacement For OEM No.	Sickle Length	Number Of Sections	OEM Section Part Number	Type Of Section	Rivet Size	OEM Head Number
	800-027	TS264985(RH)	8 FT.	31	604921H	H TS PL	9/16 OH	247990
	800-028	TS264987(LH)	8 FT.	29	604921H	H TS PL	9/16 OH	247989
	800-019	247988CR(RH)	7 FT.	27	604800	R US PL	9/16 OH	247990
	800-020	247987CR(LH)	7 FT.	25	604800	R US PL	9/16 OH	247989
	800-029	264985CR(RH)	8 FT.	31	604800	R US PL	9/16 OH	247990
	800-030	264987CR(LH)	8 FT.	29	604800	R US PL	9/16 OH	247989

NOTE: For Ford N-H #858725, order 801-017. For Ford N-H #858720, order 801-019. For Ford N-H #858724, order 801-018.  
 For Ford N-H #858719, order 801-020. For Ford N-H #858723, order 801-027. For Ford N-H #858718, order 801-029.  
 For Ford N-H #858722, order 801-028. For Ford N-H #858717, order 801-030.

Continued On Next Page. See Page 36-37 For Abbreviation Explanations. See Page 39 For Complete Price List.

(NOTE: Items not shown are available on a special order basis, Non-Stock Dealer Schedule - 202 F.O.B. Factory) Copyright 1994 Kondex

Call 1-800-444-8666

# FORD NEW HOLLAND

# KONDEX

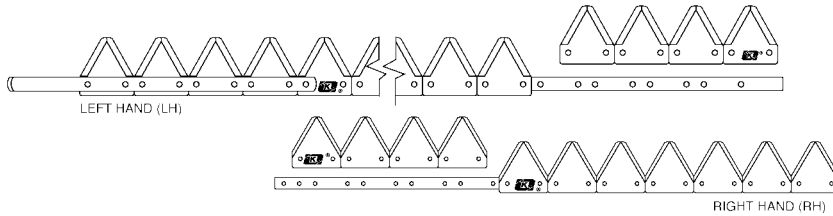

**Headless Sickles for #907, 909, 912, 1112, 1114, 1116, 116**

Bolt-On Order No.	Riveted Order No.	Replacement For OEM No.	Sickle Length	Number Of Sections	OEM Section Part Number	Type Of Section	Rivet Size	OEM Head Number
	800-013	706418(RH)	7 FT.	27	604921H	H TS PL	9/16 OH	Headless
	800-014	706417(LH)	7 FT.	25	604921H	H TS PL	9/16 OH	Headless

**NOTE: These sickles are supplied less head, but with enough sections and rivets to assemble head.**

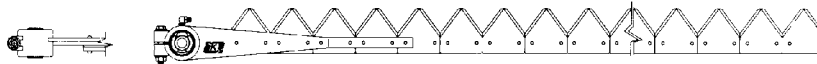

**Combines #TR75, TR85, TR95 w/Header #970, 972, 971, 973 with Twin Points**

Bolt-On Order No.	Riveted Order No.	Replacement For OEM No.	Sickle Length	Number Of Sections	OEM Section Part Number	Type Of Section	Rivet Size	OEM Head Number
	800-430	605661	16 FT.	63	694723	XH TS PL	9/16 OH	605038

**MISCELLANEOUS ITEMS**

Order Number	Replaces OEM No.	Description	Machine
920-433	127610	Bushing	Mowers #450-456, 499, 1496
920-434	134182	Bushing	Mower/Cond. #460-469
920-437	254132	Bushing	Mower/Cond. #472-479, 488, 495, 1495
901-003	247990	Sickle Head (RH)	Windrower #1112-1116
901-004	247989	Sickle Head (LH)	Windrower #1112-1116
920-436	76417	Bushing	Windrower #907-1116, 114
903-001	139180	Extension/Knifeback	All Twin Sickle Machines
529-056	26616 271967	Wear Plate	Mowers Combines
515-066	67357 137651	Low Knife Clip for Riveted or Bolted Sickles	Mower/Cond. and Windrowers

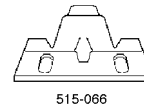

515-066

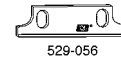

529-056

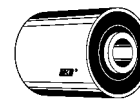

920-437

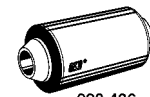

920-436

Continued On Next Page. See Page 36-37 For Abbreviation Explanations. See Page 39 For Complete Price List.

(NOTE: Items not shown are available on a special order basis, Non-Stock Dealer Schedule - 202 F.O.B. Factory) Copyright 1994 Kondex

# Call 1-800-444-8666

# KONDEX

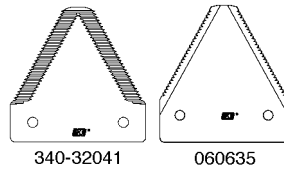

# GEHL/OWATONNA

## SICKLE SECTIONS

Order No.	Replacement For OEM No.	Section Size	Section Type	Section Thickness	Section Finish	Machine	Rivet Size
212-061	060635	Shape #2	US	XH	PL	Mowers/Conditioners	5/8 OH
211-002	340-32049	Shape #2	US	H			9/16 OH
211-232	340-32015	Shape #2	TS	H			9/16 OH
411-132	340-32041	Shape #6	TS	H		Windrowers	5/8 OH

## SICKLE ASSEMBLIES

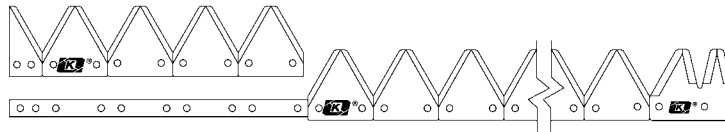

Mower/Conditioner #208, 216, 217 (9'), 235 Swing-Tongue (12'+14'), Owat #229 (9-1/2')

Windrowers #260, 265, 270, 275, 280, 281, 282, 285, 800, 900 (10'-20'), Ford #536 (9')

Bolt-On Order No.	Riveted Order No.	Replacement For OEM No.	Sickle Length	Number Of Sections	OEM Section Part Number	Type Of Section	Rivet Size	OEM Head Number
	800-350	340-32018	10 FT.	40	340-32015	H TS	9/16 OH	Headless
	800-352	340-32020	14 FT.	56	340-32015	H TS	9/16 OH	Headless

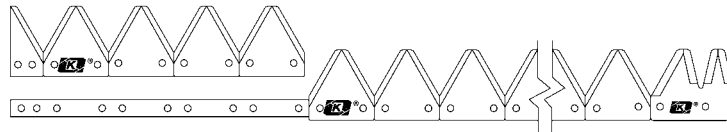

Windrower/Self Propelled #2650 (14'+16')

Bolt-On Order No.	Riveted Order No.	Replacement For OEM No.	Sickle Length	Number Of Sections	OEM Section Part Number	Type Of Section	Rivet Size	OEM Head Number
	800-352	340-32020	14 FT.	56	340-32015	H TS	9/16 OH	Headless

## MISCELLANEOUS ITEMS

Order No.	Replacement For OEM No.	Description	Machine
529-056	H7543 110-10645	Wear Plate	Mower/Conditioners
515-066	H7542	Low Knife Clip	(For 7/16" Guard Bolts older Gehl machines)
515-186	110-10157 110-10734	Low Knife Clip	(For 1/2" Guard Bolts Owatonna machines newer Gehl machines)

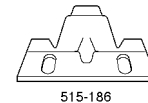
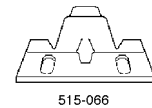

Continued On Next Page. See Page 36-37 For Abbreviation Explanations. See Page 39 For Complete Price List.

(NOTE: Items not shown are available on a special order basis, Non-Stock Dealer Schedule - 202 F.O.B. Factory) Copyright 1994 Kondex

# FAX 1-800-342-7252

# HART-CARTER

(HCC. Inc.)

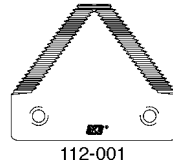

# KONDEX

## SICKLE SECTIONS

Order No.	Replacement For OEM No.	Section Size	Section Type	Section Thickness	Section Finish	Machine	Rivet Size
112-001	277444	Shape #9	TS	XH	PL	All Floating Bars	5/8 CTSK

## SICKLE ASSEMBLIES

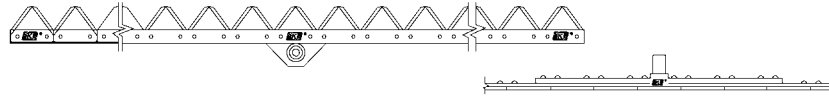

### Floating Bars Generation I, Old Style

Bolt-On Order No.	Riveted Order No.	Replacement For OEM No.	Sickle Length	Number Of Sections	OEM Section Part Number	Type Of Section	Rivet Size	OEM Head Number
800-325	880083		13 FT.	52	277444	XH TS PL	5/8 CTSK	880010

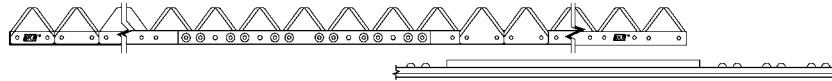

### Floating Bars Generation II, Bolted Head

Bolt-On Order No.	Riveted Order No.	Replacement For OEM No.	Sickle Length	Number Of Sections	OEM Section Part Number	Type Of Section	Rivet Size	OEM Head Number
800-094	880469		13 FT.	52	277444	XH TS PL	5/8 CTSK	580442

### Floating Bars Generation III, Wobble Drive

Bolt-On Order No.	Riveted Order No.	Replacement For OEM No.	Sickle Length	Number Of Sections	OEM Section Part Number	Type Of Section	Rivet Size	OEM Head Number
800-127	880666		13 FT.	52	277444	XH TS PL	5/8 CTSK	880662
800-131	880670		20 FT.	80	277444	XH TS PL	5/8 CTSK	880662

Note: For Duetz-Allis headers, do not order above part numbers. Order in Duetz-Allis listing, because sickles are one section longer.

## MISCELLANEOUS ITEMS

Order No.	Replacement For OEM No.	Description	Machine
529-056	234140	Wear Plate	All Headers
515-016	232125	Low Knife Clip	All Headers
920-223	243660	Bearing	Head #880662
904-525	-	5/8" Bolt & Lock Nut for Sections (50 pcs. includes wrench)	
904-528	-	1" Bolt & Lock Nut for Knifehead (25 pcs. includes wrench)	

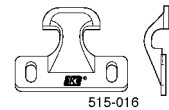
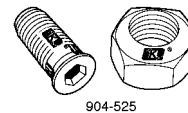
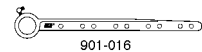

Continued On Next Page. See Page 36-37 For Abbreviation Explanations. See Page 39 For Complete Price List.

(NOTE: Items not shown are available on a special order basis, Non-Stock Dealer Schedule - 202 F.O.B. Factory) Copyright 1994 Kondex

**Call Toll-Free: 1-800-444-8666**



# KONDEX

# HESSTON

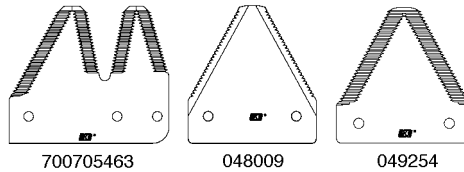

## SICKLE SECTIONS

Order No.	Replacement For OEM No.	Section Size	Section Type	Section Thickness	Section Finish	Machine	Rivet Size	
212-133	048108	Shape #2	SM	R	PL	Mower/Conditioners	9/16 OH	
212-063	048009	Shape #2	US	R	PL	Windrowers	9/16 OH	
212-003	049213	Shape #2	TS	R	PL	All Models	9/16 OH	
212-012	049254	Shape #2	TS	H	PL		9/16 OH	
212-001	700705300	Shape #2	TS	XH	PL		9/16 OH	
211-232	700702966	Shpae #2	TS	H			9/16 OH	
212-262	748210	Overlap	TS	H	PL	Countersunk Botton - Overlap	9/16 CTSK	
519-002	748152	Overlap	Sawtooth			Overlap Area	9/16 CTSK	
<b>Note: For Overlap Sections on cards see page 34.</b>								
612-050	700705463, 748137	End Section (RH)						5/8 OH
612-090	700705462, 748145	End Section (LH)						5/8 OH

## SICKLE ASSEMBLIES

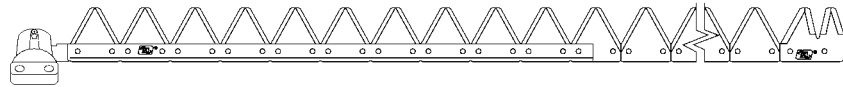

### Windrowers #520, 620, 1014, 6200, 6400, 6450, 6465 Header, 6600, 6610 Gehl 2230 (12'), Case 1275

Bolt-On Order No.	Riveted Order No.	Replacement For OEM No.	Sickle Length	Number Of Sections	OEM Section Part Number	Type Of Section	Rivet Size	OEM Head Number
801-397	800-397	6497119	14 FT.	56	049254	H TS PL	9/16 OH	6497416

**NOTE: Knifehead #6193577 Has 11 Holes, #6497416 Has 21 Holes.**

## MISCELLANEOUS ITEMS

Order No.	Replacement For OEM No.	Description	Machine
901-055	6497416	Sickle Head	"Long Head" (21 holes)
515-066	241216	Low Knife Clip for Riveted or Bolted Sickles	Mower/Conditioners Windrowers
515-126	142984	High Knife Clip for over the Knifehead	

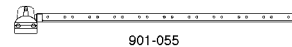
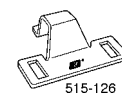
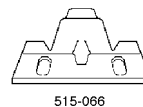

Continued On Next Page. See Page 36-37 For Abbreviation Explanations. See Page 39 For Complete Price List.

(NOTE: Items not shown are available on a special order basis, Non-Stock Dealer Schedule - 202 F.O.B. Factory) Copyright 1994 Kondex

# FAX 1-800-342-7252

# KOSCH

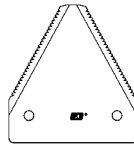

K-165

# KONDEX

## SICKLE SECTIONS

Order No.	Replacement For OEM No.	Section Size	Section Type	Section Thickness	Section Finish	Machine	Rivet Size
211-002	K-165	Shape #2	US	H		All Mowers	9/16 OH

## MISCELLANEOUS ITEMS

Order No.	Replacement For OEM No.	Description	Machine
920-152	K-120	Pitman Wood	Mowers
529-056	K-162	Wear Plate	Mowers
920-128	K-133	Pitman Strap (front)	Mowers
920-129	K-137	Pitman Strap (rear)	Mowers
515-036	K-188B	Low Knife Clip for Riveted Sickles Only	Mowers

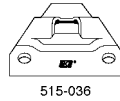
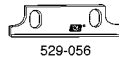

## MISCELLANEOUS ITEMS

Order No.	Replacement For OEM No.	Description	Machine
515-026	K-179B K-065, K-067	High Knife Clip	Mowers
920-127	K-163	Outer Shoe Plate	Mowers
920-126	K-1918	Ledger Plate	Mowers
920-140	K-170	Rear Guide, Upper	Mowers

# J. E. LOVE

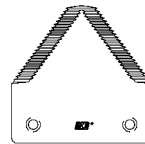

L192D

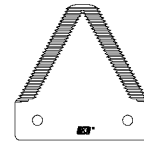

L193

## SICKLE SECTIONS

Order No.	Replacement For OEM No.	Section Size	Section Type	Section Thickness	Section Finish	Machine	Rivet Size
211-022	L191	Shape #1	US	H		Green Pea	9/16 OH
211-261	L192D	Shape #11	TS	XH		All Floating Headers	5/8 CTSK
212-121	L192DCR	Shape #11	TS	XH	PL		5/8 CTSK
211-321	L193	Shape #11	TS	XH		King Kut	5/8 OH
212-291	L193CR	Shape #11	TS	XH	PL		5/8 OH
622-041	L212A	Twin Pt. Shape #8	TS	XH		King Kut	5/8 Bolt

Order No.	Replacement For OEM No.	Description	Machine
529-056	L220	Wear Plate	All Floating Headers
515-016	L221	Low Knife Clip	All Floating Headers
904-525	5/8" Bolt & Lock Nut for sections (50 pcs., Allen wrench included)		
904-528	1" Bolts & Lock Nut for knifehead (25 pcs., Allen wrench included)		

## MISCELLANEOUS ITEMS

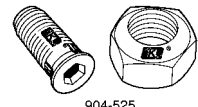
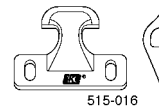

Continued On Next Page. See Page 36-37 For Abbreviation Explanations. See Page 39 For Complete Price List.

(NOTE: Items not shown are available on a special order basis, Non-Stock Dealer Schedule - 202 F.O.B. Factory) Copyright 1994 Kondex

**Centralize with Central Supply & Rubber Co.**  
**Our Representatives Receive Full Credit On All Phone & Fax Orders!**

# KONDEX

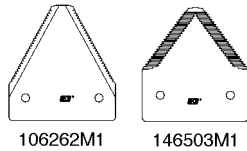

# MASSEY-FERGUSON

## SICKLE SECTIONS

Order No.	Replacement For OEM No.	Section Size	Section Type	Section Thickness	Section Finish	Machine	Rivet Size
112-001	1053209M1	Shape #9	TS	XH	PL	H-C Floating Headers	5/8 CTSK
211-201	130356M1	Shape #3	US	XH		Mowers #30, 31, 32, 51, 52,	5/8 OH
212-091	669807M1	Shape #3	US	XH	PL	71, 135, MH #5, 6, 40	5/8 OH
<b>NOTE: L1262, Order #211-223 (See Below)</b>							
211-022	668010M1	Shape #1	US	H		Mower #AEO, PEO, FEO, #41, 60	5/8 OH
211-223	1041472M1	Shape #3	US	R		Windrower #35, 655, 775	9/16 OH
212-103	160262M1	Shape #3	US	R	PL		9/16 OH
212-412	1046776M1	Shape #3	TS	H	PL		5/8 OH
412-003	261431M1	Shape #12	TS	R	PL	All Combines	9/16 OH
412-032	146503M2	Shape #12	TS	H	PL	Windrower #34, 36, 44	5/8 OH
612-062	264994M2	Half Section (RH)				All Combines	5/8 OH
612-072	264993M2	Half Section (LH)					5/8 OH
<b>NOTE: For 160254M1 &amp; 160255M2, Order 412-003. For 26143M1H, Order 412-032</b>							
622-011	1904914M2	Twin Point Shape #8 TS		XH	PL	Power Cut	5/8 Bolt

## SICKLE ASSEMBLIES

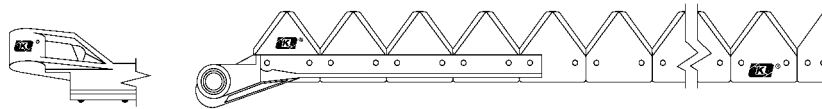

### Windrower #34, 36, 44

Bolt-On Order No.	Riveted Order No.	Replacement For OEM No.	Sickle Length	Number Of Sections	OEM Section Part Number	Type Of Section	Rivet Size	OEM Head Number
801-403	800-403	146459M91	14 FT.	55	261431M1	R TS PL	9/16 OH	144306M91

Continued On Next Page. See Page 36-37 For Abbreviation Explanations. See Page 39 For Complete Price List.

(NOTE: Items not shown are available on a special order basis, Non-Stock Dealer Schedule - 202 F.O.B. Factory) Copyright 1994 Kondex

**We Ship  
Over 95%  
Of Our Orders  
The Same Day!**

**Centralize**  
your parts orders with  
**Central Supply**  
Order Via Fax Toll-Free:  
**1-800-342-7252**

# MASSEY-FERGUSON

# KONDEX

## SICKLE ASSEMBLIES

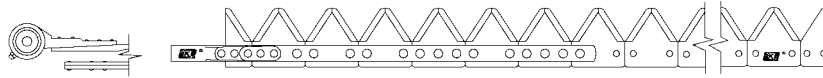

Combines #410, 510, 540, 550, 750, 760 with Rigid Header #1859

Bolt-On Order No.	Riveted Order No.	Replacement For OEM No.	Sickle Length	Number Of Sections	OEM Section Part Number	Type Of Section	Rivet Size	OEM Head Number
	800-338	260611M94	13 FT.	51	146503M2	H TS PL	5/8 OH	239481M92

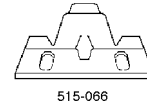
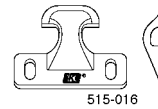
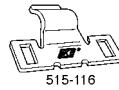
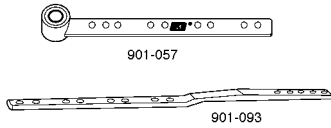

## MISCELLANEOUS ITEMS

Order Number	Replaces	Description	Machine	Order Number	Replaces	Description	Machine
920-222	143015M1	Bushing		529-056	206196M1 231303M1 1039627M1	Wear Plate	Mowers Windrowers Combines
901-057	1043844M91	Sickle Head	Windrower #655, 775, 785 w/Draper Header	515-066	130431M1 1041469M1 1055108M1	Low Knife Clip for Riveted or Bolted Sickles	Mower/Cond. Windrower
901-054	1041478M91	Bushing		515-116	206195M1 143241M1	Low Knife Clip for Riveted or Bolted Sickles	Combines with Rigid Headers
901-095	148357M91	Spring/Knifehead	Combines	515-016	1053175M1	Low Knife Clip	Combine w/1859 Floating Header
901-093	147522M2	Spring/Knifehead	Combines				

## NEW IDEA

### SICKLE SECTIONS

Order No.	Replacement For OEM No.	Section Size	Section Type	Section Thickness	Section Finish	Machine	Rivet Size
211-002	OU577HS	Shape #2	US	H		Mowers, Mower/ Conditioners, Combines	9/16 OH

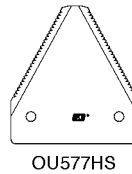

### MISCELLANEOUS ITEMS

Order No.	Replacement For OEM No.	Description	Machine
529-056	290815	Wear Plate	Mower, Mower/Cond. Combines
515-066	0145HS 290816	Low Knife Clip for Riveted or Bolted Sickles	Mowers
920-330	W20HSA	Pitman Wood	Mowers

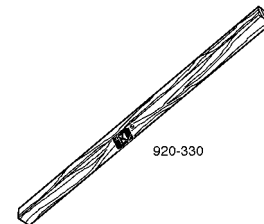
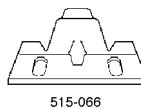

Continued On Next Page. See Page 36-37 For Abbreviation Explanations. See Page 39 For Complete Price List.

(NOTE: Items not shown are available on a special order basis, Non-Stock Dealer Schedule - 202 F.O.B. Factory) Copyright 1994 Kondex

# KONDEX

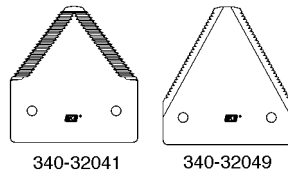

# OWATONNA

## SICKLE SECTIONS

Order No.	Replacement For OEM No.	Section Size	Section Type	Section Thickness	Section Finish	Machine	Rivet Size
211-002	340-32049	Shape #2	US	H		Mower/Conditioners	9/16 OH
211-232	340-32015	Shape #2	TS	H		Windrowers	9/16 OH
212-133	340-16456	Shape #2	SM	R	PL		9/16 OH
411-132	340-32041	Shape #6	TS	H		Windrowers	9/16 OH

## SICKLE ASSEMBLIES

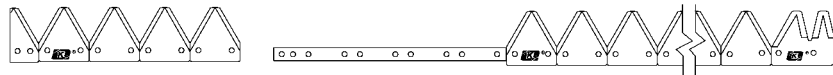

Mower/Conditioner #208, 216, 217, (9'), 235 Swing-Tongue (12'+14') Model #229 (9-1/2')  
 Windrowers #260, 265, 275, 280, 281, 282, 285, 800, 900 (10'-20'), Ford #536 (9')

Bolt-On Order No.	Riveted Order No.	Replacement For OEM No.	Sickle Length	Number Of Sections	OEM Section Part Number	Type Of Section	Rivet Size	OEM Head Number
	800-350	340-32018	10 FT.	40	340-32015	H TS	9/16 OH	Headless
	800-352	340-32020	14 FT.	56	340-32015	H TS	9/16 OH	Headless

NOTE: For #340-32056 (9') & 34018927 (9'), order 340-32016. For 340-19605 (14'), order 340-32020.

## MISCELLANEOUS ITEMS

Order No.	Replacement For OEM No.	Description	Machine
529-056	110-10645	Wear Plate	Windrowers
515-186	110-10157 110-10734	Low Knife Clip for Riveted or Bolted Sickles	Windrower with 1/2" Guard Bolts

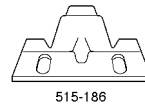

NOTE: Above knife clip has 1/2" bolt holes

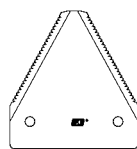

646

# TRIUMPH

## SICKLE SECTIONS

Order No.	Replacement For OEM No.	Section Size	Section Type	Section Thickness	Section Finish	Machine	Rivet Size
211-022	646	Shape #1	US	H		Mowers	9/16 OH

## MISCELLANEOUS ITEMS

Order No.	Replacement For OEM No.	Description	Machine
920-128	1911	Pitman Strap (front)	Mowers
920-129	1912	Pitman Strap (rear)	Mowers
515-046	1887	Low Knife Clip for Riveted Sickles only	Mowers
515-026	127	High Knife Clip	Mowers

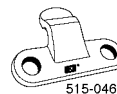

Continued On Next Page. See Page 36-37 For Abbreviation Explanations. See Page 39 For Complete Price List.

(NOTE: Items not shown are available on a special order basis, Non-Stock Dealer Schedule - 202 F.O.B. Factory) Copyright 1994 Kondex

# KONDEX

# VERSATILE

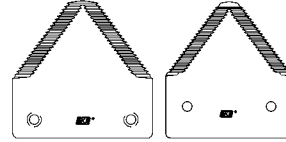

SW1616

SW1776

### SICKLE SECTIONS

Order No.	Replacement For OEM No.	Section Size	Section Type	Section Thickness	Section Finish	Machine	Rivet Size
212-213	SW1616CR	Shape #4	TS	R (Low-Rise Shoulder)	PL	#10 - #4400	9/16 CTSK
411-083	SW1776	Shape #5	TS	R		#10 - #4400	9/16 CTSK
412-063	SW1776CR	Shape #5	TS	R (High-Rise Shoulder)	PL	#10 - #4400	9/16 CTSK

### MISCELLANEOUS ITEMS

Order No.	Replacement For OEM No.	Description	Machine
515-076	SW202	Low Knife Clip for Rivets and Bolts	All Windrowers
904-529		9/16" Bolt & Lock Nut for sections (50 pcs., Allen wrench included)	
904-528		1" Bolts & Lock Nut for knifehead (25 pcs., Allen wrench included)	

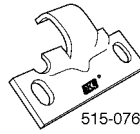

515-076

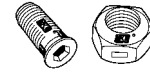

904-529

# WHITE FARM

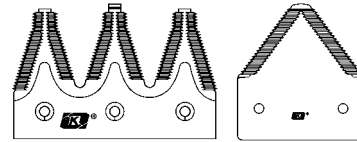

621-022

412-122

### SICKLE SECTIONS

Order No.	Replacement For OEM No.	Section Size	Section Type	Section Thickness	Section Finish	Machine	Rivet Size
211-223	875785L	Shape #3	US	R		Windrowers	9/16 OH
212-412	31-7970650	Shape #3	TS	H	PL		5/8 OH
621-022	31-1714750	4-1/2x3-5/16	TS	H	(3-Point)	Kwik-Cut 20/box	1/4x5/8 Bolts

Continued On Next Page. See Page 36-37 For Abbreviation Explanations. See Page 39 For Complete Price List.

(NOTE: Items not shown are available on a special order basis, Non-Stock Dealer Schedule - 202 F.O.B. Factory) Copyright 1994 Kondex

**Call Toll-Free: 1-800-444-8666**

**We Ship Over 95% Of Our Orders The Same Day!**

## "BIG TOOTH" SICKLE SECTIONS

## KONDEX

Designed and built to last much longer and stay sharper than ordinary sickle sections.  
 This unique coined, top serrated (10 serrations per inch) section, is the ideal specialized tool  
 for coarser, dryer stem crops. (Not recommended for fine stemmed native grasses or similar crops.)

Order No.	Replacement For OEM No.	Section Size	Description
<b>CASE/IH</b>			
231-211	826720C2BT	Shape #2	XH-TS Black Big Tooth Section - 2 hole
232-001	596321R3BT	Shape #2	XH-TS Chrome Big Tooth Section
432-071	634794RZBT	Shape #10	XH-TS Chrome Big Tooth Section
632-031	Swathers (TJ7000)	Shape #7	XH-TS Chrome Big Tooth Section - CTSK
<b>JOHN DEERE</b>			
232-242	E45996BT	Shape #1	H-TS Chrome Big Tooth Section
232-241	E76370BT	Shape #1	XH-TS Chrome Big Tooth Section
432-021	H84415	Shape #13	XH-TS Chrome Big Tooth Section - CTSK
432-001	H125893BT	Shape #13	XH-TS Chrome Big Tooth Section
632-011	Swathers (DC6000)	Shape #8	XH-TS Chrome Big Tooth Section - CTSK
<b>DEUTZ-ALLIS (AGCO)</b>			
432-051	71135135BT	Shape #14	XH-TS Chrome Big Tooth Section
<b>HART-CARTER</b>			
132-001	277444BT	Shape #9	XH-TS Chrome Big Tooth Section - CTSK
<b>HESSTON</b>			
632-031	Swathers	Shape #7	XH-TS Chrome Big Tooth Section - CTSK
<b>LOVE</b>			
232-121	L192DCRBT	Shape #11	XH-TS Chrome Big Tooth Section - CTSK
231-261	L192DBT	Shape #11	XH-TS Black Big Tooth Section - CTSK
231-321	L193BT	Shape #11	XH-TS Black Big Tooth Section
632-041	King Cut	Shape #8	XH-TS Black Big Tooth Section - CTSK
<b>MASSEY-FERGUSON</b>			
232-412	1046776M1BT	Shape #3	H-TS Chrome Big Tooth Section
231-411	1071707M1BT	Shape #3	XH-TS Black Big Tooth Section
632-011	Power Cut (TJ6000)	Shape #8	XH-TS Chrome Big Tooth Section - CTSK
432-032	146503M2BT	Shape #12	XH-TS Chrome Big Tooth Section
<b>NEW HOLLAND</b>			
632-051	Combines	Shape #7	XH-TS Black Big Tooth Section - CTSK
632-031	Swathers (DC7000)	Shape #7	XH-TS Chrome Big Tooth Section - CTSK
<b>VERSATILE</b>			
231-053	SW166BT	Shape #4	XH-TS Black Big Tooth Section
431-083	SW1776BT	Shape #5	XH-TS Black Big Tooth Section

## KONDEX LICKITY-SPLIT™ REPAIR KITS

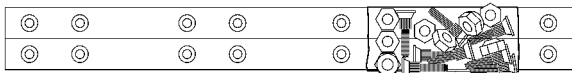

Order No.	Description	
711-012	2" hole spacing repair kit	Nuts/Bolts/Splices
711-010	2-1/16" hole spacing repair kit	in Poly Bag
711-011	2-1/8" hole spacing repair kit	

**NOTE: Air tools not recommended for assembly of splice kit.**

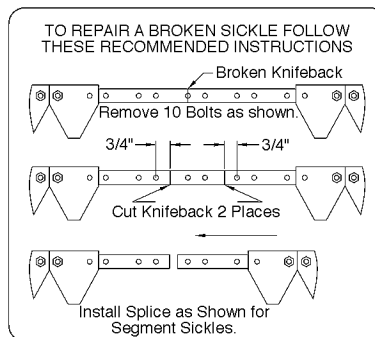

Lickity-split will mend most broken sickles.

For the strongest joint possible using Lickity-split, follow the recommended instructions.

Breaks near the head of the sickle can be moved to the tail end with Lickity-split. Some drilling may be required to mount the knifehead in new positions.

Continued On Next Page. See Page 36-37 For Abbreviation Explanations. See Page 39 For Complete Price List.

(NOTE: Items not shown are available on a special order basis, Non-Stock Dealer Schedule - 202 F.O.B. Factory) Copyright 1994 Kondex

# KONDEX

## SECTION RIVETS



### OVAL HEAD RIVETS - One Pound Plastic Packages (For use in Straight Hole Sections, Not Countersunk Sections)

Order No.	Diameter	Length	Rivet Application
904-020	#5-1/2 (.211)	1/2"	For Reg. & Hvy. Sections For X-Hvy. Sections
904-021	#5-1/2 (.211)	9/16"	
904-022	#5-1/2 (.211)	5/8"	
904-023	#5-1/2 (.211)	11/16"	For Knifeheads
904-024	#5-1/2 (.211)	3/4"	
904-025	#5-1/2 (.211)	7/8"	
904-026	#5-1/2 (.211)	15/16"	
904-027	#5-1/2 (.211)	1"	
904-028	#5-1/2 (.211)	1-1/16"	
904-030	#5-1/2 (.211)	1-1/4"	
904-031	#5-1/2 (.211)	1-3/8"	For Sections on J-D 55, 95, 105 & W-F Combines
904-040	1/4" (.250)	5/8"	
904-041	1/4" (.250)	7/8"	
904-042	1/4" (.250)	1"	For Knifeheads on C/IH, J-D 55, 95, 105 & W-F Combines



### OVAL HEAD RIVET ASSORTMENTS

Order No.	Replaces	Description of Assortment
904-109	KON-700 100H	Designed for most 7' Assemblies, Consists of 56 pcs. 9/16" OH Rivet, 10 pcs. 15/16" OH Rivet
904-110	KON-900 200H	Designed for most 9' Assemblies Consists of 70 pcs. 5/8" OH Rivet, 7 pcs. 15/16" OH Rivet, 5 pcs. 1-1/4" OH Rivet

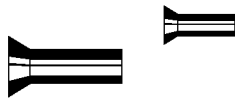

### COUNTERSUNK RIVETS - One Pound Plastic Packages (For use in Countersunk Hole Sections, Not Straight Sections)

Order No.	Diameter	Length	Rivet Application
904-002	#5-1/2 (.211)	9/16"	For Reg. & Hvy. Sections For X-Hvy. Sections
904-003	#5-1/2 (.211)	5/8"	
904-004	#5-1/2 (.211)	7/8"	For Knifeheads
904-005	#5-1/2 (.211)	15/16"	
904-006	#5-1/2 (.211)	1"	
904-007	#5-1/2 (.211)	1-1/16"	
904-008	#5-1/2 (.211)	1-1/8"	
904-009	#5-1/2 (.211)	1-1/4"	Ledger Plate in DM700 & FD800 Guard
904-010	#5-1/2 (.211)	1-3/8"	For Ledger Plate in M-F Guard

## BOLT-ON FASTENERS



### 7/32" Dia. Bolt-On Fasteners

Order No.	Lgth.	Pkg. Qty.	Bolt-On Fastener Application
904-500	5/8"	50 pcs.	Bolt & Lock Nut for Std. Straight Hole Sections
904-501	1"	25 pcs.	Bolt & Lock Nut for use in Knifeheads
904-504	1-1/4"	25 pcs.	Bolt & Lock Nut for use in Knifeheads
904-513	1"	15 pcs.	Bolts & Lock Nuts } Knifehead Bolts & Lock Nuts } Assortment
	1-1/4"	10 pcs.	
904-502	N/A	100 pcs.	Replacement Std. Lock Nuts
904-508	5/8"	50 pcs.	Bolts & Lock Nuts } 60 Piece Bolts & Lock Nuts } Standard Bolts & Lock Nuts } Assortment
	1"	5 pcs.	
	1-1/4"	5 pcs.	

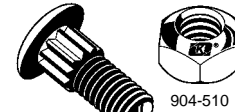

### 1/4" Dia. Bolt-On Fasteners

Order No.	Lgth.	Pkg. Qty.	Bolt-On Fastener Application
904-510	5/8"	50 pcs.	Bolts & Lock Nuts for use in Sections
<b>NOTE: 5/8" Length bolt is as shown with Knifehead Shoulder</b>			
904-511	1-1/4"	25 pcs.	Bolts & Lock Nuts for use in Knifeheads
<b>NOTE: 1-1/4" Length bolt is Gr.8 Cap Screw without ribbed shoulder. Use in J-D #95-105, some Case/IH Knifeheads, and White Kwik Kut Headers.</b>			

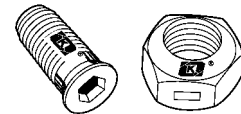

### New Bolt-On Fasteners for J.E. Love, Hart-Carter, & Versatile Assemblies

Order No.	Lgth.	Pkg. Qty.	Bolt-On Fastener Application
904-529	9/16"	50 pcs.	Bolts & Lock Nuts for Versatile
904-525	5/8"	50 pcs.	Bolts & Lock Nuts for J.E. Love & Hart-Carter
904-528	1"	25 pcs.	Bolts & Lock Nuts for Versatile, J.E. Love & Hart-Carter Knifeheads.

**NOTE: Allen Wrench included with each of the above part numbers.**

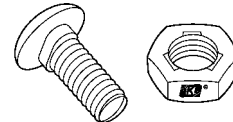

### New Fasteners For The Case/IH 1010/1020 1-1/2" Cut System

Order No.	Lgth.	Pkg. Qty.	Bolt-On Fastener Application
904-526	17/32"	50 pcs.	Oval Shoulder Bolt & Jam Nut for Case/IH 1010/1020 3-Hole Sections
904-527	1-1/8"	25 pcs.	Oval Shoulder Bolt & Jam Nut for Case/IH 1010/1020 3-Hole Sections

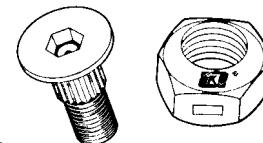

### New Bolts & Lock Nuts For Ford New Holland Twin Sickle Bolted Assemblies - 82° CTSK

Order No.	Lgth.	Pkg. Qty.	Bolt-On Fastener Application
904-534	1/2"	25 pcs.	Ford New Holland Overlap

Continued On Next Page. See Page 36-37 For Abbreviation Explanations. See Page 39 For Complete Price List.

(NOTE: Items not shown are available on a special order basis, Non-Stock Dealer Schedule - 202 F.O.B. Factory) Copyright 1994 Kondex



# KONDEX

## UNIVERSAL WEAR PLATE

No.	Description	Replacement For
529-056	Wear Plate 6"	A-C #1116532, 1176537 Deere #E47954, Z5926H Ford #141021 Gehl #H7543 H-C #MC468 IHC #MC468, 179759C1 Kosch #K162 Love #L220 M-F #206196M1, 231303M1 N-H #26616, 271967 N-I #290815 OMC #110-10645 White #501015E



## UNIVERSAL SHIMS

No.	Description
920-386	.010 Shim
920-387	.024 Shim

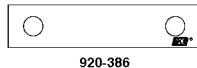

## UNIVERSAL PITMAN WOODS

No.	Description
920-150	UPW375 Pitman Wood

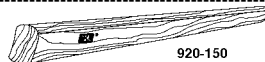

**NOTE:** This universal Pitman Wood has been designed to replace most Pitman Woods.

Drilled Pitman Woods for specific applications are listed in Miscellaneous Section for each O.E.M.

## KNIFE CLIPS

UNIVERSAL KNIFE CLIPS	
No.	Application
515-126	Knifehead Clip - for all knifeheads <b>except</b> H-C, Love, Versatile For Bolts or Rivets
515-066	Low Knife Clip - for Mowers, Mower/Cond., & Windrowers <b>except</b> Versatile For Bolts or Rivets
515-116	Low Knife Clip - for all Combines <b>except</b> those w/H-C & Love headers For Bolts or Rivets

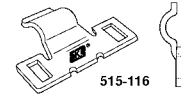
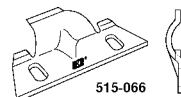
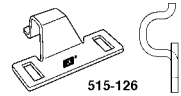

KNIFE CLIPS FOR HART-CARTER & J.E. LOVE	
No.	Application
515-016	Low Knife Clip - for combines with H-C & Love headers

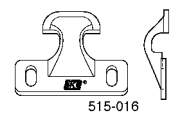

KNIFE CLIPS FOR VERSATILE	
No.	Application
515-076	Low Knife Clip - for Versatile Sickle Assemblies For Bolts or Rivets

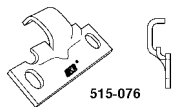

**NOTE:** Kondex Versatile Knife Clip has been redesigned and improved as follows:  
 - Heavier than OEM clip  
 - Wider wear pads for longer life  
 - Higher arch for bolted sickles

## H & S END SECTIONS

The H & S End Sections are designed to replace the half-sections on most sickles. See mounting instructions.

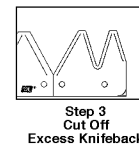
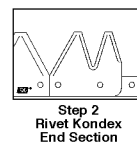
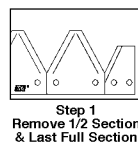
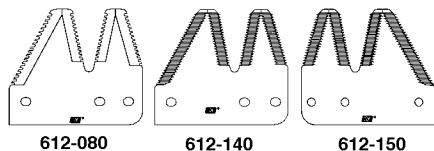

H & S END SECTIONS - 10 PER BOX PLUS RIVETS		
No.	Replaces	Description
612-130	1-S	Smooth - (RH)
	2-US	----- (SUB. #612-140)
612-140	3-TS	Topserrated - (RH)
612-150	LH-TS	Topserrated - (LH) (For use in Twin Sickle Applications)

H & S END SECTIONS - 2 PER CARD PLUS RIVETS	
No.	Description
712-730	Card of 2 (3-TS) End Sections Plus Rivets
712-750	Card of 2 (LH-TS) End Sections Plus Rivets (For use in Twin Sickle Applications)

Continued On Next Page. See Page 36-37 For Abbreviation Explanations. See Page 39 For Complete Price List.

(NOTE: Items not shown are available on a special order basis, Non-Stock Dealer Schedule - 202 F.O.B. Factory) Copyright 1994 Kondex

# KONDEX

## MALLEABLE GUARDS

No.	Description	Replacement For
920-103	Center Guard - 7/16" Bar DM-700, N-13, EZU-41	A-C #802495 J-D #AZ3441H, #AZ2131H IHC #M2041 (MA, MB, MC) N-H #34885, #39653 N-I #50HS4A, #143HSA
920-104	Outer Guard - 7/16" Bar DM-700-R, N-13-A	Above Listing
920-105	Inner Guard - 7/16" Bar DM-700-L, N-13-A	Above Listing
920-118	Ledger Plate DF780	Replaces Ledger Plate in above Guards <b>(Use #904-009 CTSK Rivet)</b>
920-277	Center Guard	M-F 679837M91, M-F 668593M91 M-F 668597M91, M-F 668613M91

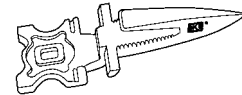
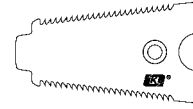
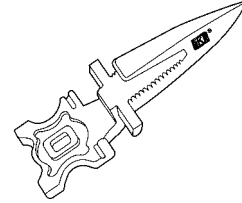

## GUARD BOLTS

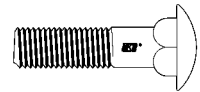

No.	Description	Application
904-515	7/16x1-1/2 Plow Bolt (12 pcs.), 7/16x1-3/4 Plow Bolt (18 pcs.), 7/16 Conical Nut (30 pcs.)	Assortment for 7' Hay Mowers
904-518	3/8x1-1/4 Carriage Bolt (25 pcs.), 3/8 Hex Nut (50 pcs.), 3/8x1-1/2 Carriage Bolt (25 pcs.)	Assortment for 12' Bar Using 3/8 Carr. Bolts
904-519	7/16" Conical Nut (25 pcs. in Clear Plastic Box)	Hay Mower Applications

## OVERLAP SECTIONS - 10 PER BOX

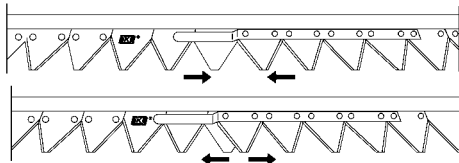

No.	CTSK Top or Bottom	Section Description And Applications	OEM Part No.
212-262	Bottom	(RH) for Hesston & Case/IH Machines (LH) for New Holland Machines	748210 706424
519-002	Top	(LH) for Hesston & Case/IH Machines Sawtooth Design	748152
212-232	Top	(RH) for New Holland Machines	706423

## OVERLAP SECTION SETS - CARDED

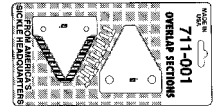

No.	Package Quantity	Application
711-001	3 - 212-262 2 - 519-002 10 - CTSK Rivets	For Hesston & Case/IH Machines one complete set for left & right hand sickles
711-002	2 - 212-232 3 - 212-262 10 - CTSK Rivets	For New Holland Machines, one complete set for left & right hand sickles
711-003	3 - 212-342 1 - 212-352 8 - CTSK Rivets	For John Deere Machines, one complete set for left & right hand sickles
711-018	3 - 212-262 2 - 519-002 10 - CTSK Bolts & Nuts	Hesston Mower/Conditioner

Continued On Next Page. See Page 36-37 For Abbreviation Explanations. See Page 39 For Complete Price List.

(NOTE: Items not shown are available on a special order basis, Non-Stock Dealer Schedule - 202 F.O.B. Factory) Copyright 1994 Kondex

*Centralize  
with  
Central Supply!*

**Call Toll-Free  
1-800-444-8666  
Fax Toll-Free  
1-800-342-7252**

# KONDEX

# FLEX TINES

## FLEX TINES FOR COMBINE REELS WITH WOOD BATS

No.	Qty. Per Box	Description
920-246	50 pcs.	Flex Tines for Wood Bats Includes Hardware for Mounting

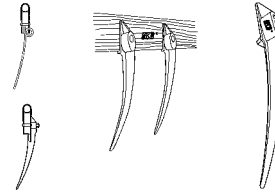

## FLEX TINES FOR COMBINE REELS WITH TEAR DROP STYLE BATS ON THESE COMBINES

Case/IH Combines w/1010, 1020 Header  
(where tine is mounted on backside of bat)

Deutz-Allis

John Deere Combines w/900 Series Header

Massey-Ferguson - New Holland

Combines with Headers and Reels by Hart-Carter

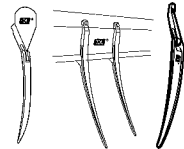

No.	Qty. Per Box	Description
920-366	50 pcs.	Flex Tines for Tear Drop Bats in Above Listing Includes Hardware & Mounting

**Design Features**  
**3 Mounting Holes On Wood Bat Tines**  
**5/8" Longer Than Old Design - 8-1/4"**  
**Patented Bottom which makes Tines more durable**  
**Reduces Downtime**  
**Easy To Install**  
**Prevents Crop Wrapping**  
**Heavier than competitive Tines**

### ORDERING INFORMATION

To Determine the Approximate Quantity Required. Multiply the Header Length in Feet by Fifteen Pieces. (Example: Deutz-Allis 13 Ft. x 15 = 192 pcs.)

## DRILLED KNIFEBACK



Order No.	O.E.M.	Replacement For OEM No.	Length	Knifeback Size	Machine	Hole Spacing
902-025	Case/IH	M537C	7 FT.	1/4 x 3/4		
902-021	Case/IH	458970R1	7 FT.	1/4 x 3/4	Mowers, Series #100	2-1/16"
902-022	Case/IH	463184R1	9 FT.	1/4 x 3/4	#1100, 1300	
902-108	Deere	JD-9	9 FT.	1/4 x 3/4	47, 50, 250-350, 450, 3700	2"
902-116	Deere	JD-7	7 FT.	1/4 x 3/4	Mowers #5 - #39	2"
902-117	Deere	JD-9	9 FT.	1/4 x 3/4		
902-092	Hesston	429506	12 FT.	1/4 x 3/4	All Case/IH, Hesston and New Holland Mowers with Single Sickles	2-1/6"
902-079	Triumph	1873	6 FT.	1/4 x 3/4	Mowers #2500, 3500	

## TWIN POINT SICKLE SECTIONS

Special Heat Treat.	Standard Section	Section Size	Type of Section	Holes	Machine	
N/A	622-101	Shape #8	TS XH PL	Straight	H-C Gen I, II, III (TJ5000)	
N/A	622-041	Shape #8	TS XH	CTSK	Love King Kut	
N/A	622-011	Shape #8	TS XH PL	CTSK	M-F Power Cut (TJ6000) J-D Swathers (DC6000)	
N/A	622-091	Shape #7	TS XH	Straight	Case/IH #820	
N/A	622-021	Shape #7	TS XH PL	Straight	J-D Combines (DC890C)	
N/A	622-051	Shape #7	TS XH	CTSK	N-H Combines	
N/A	622-031	Shape #7	TS XH PL	CTSK	Case/IH Swathers (TJ7000) N-H Swathers (DC7000) Hess Swathers	
N/A	622-251	3 x 3	TS XH PL	3 Slotted	Case/IH #1970390C1PL	(Not Shown)

Continued On Next Page. See Page 36-37 For Abbreviation Explanations. See Page 39 For Complete Price List.

(NOTE: Items not shown are available on a special order basis, Non-Stock Dealer Schedule - 202 F.O.B. Factory) Copyright 1994 Kondex

**HAY EQUIPMENT**

**KONDEX**

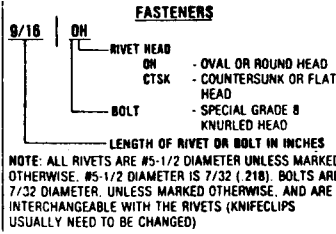
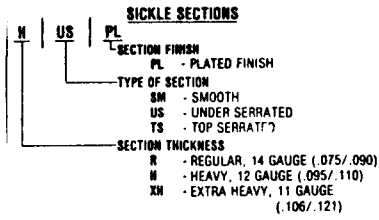

**-SICKLE SECTIONS-**

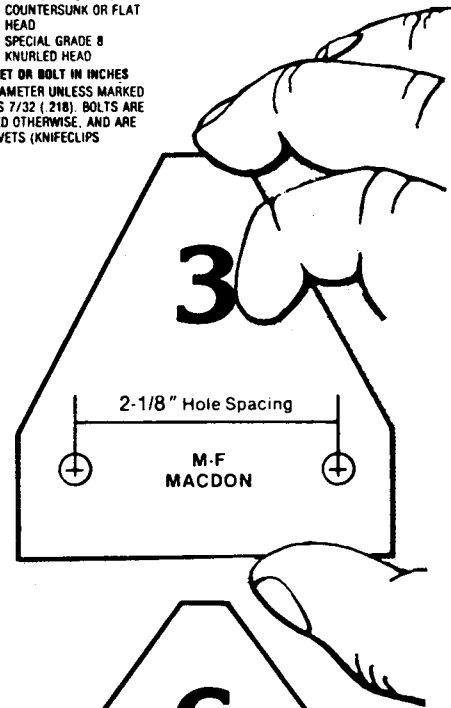
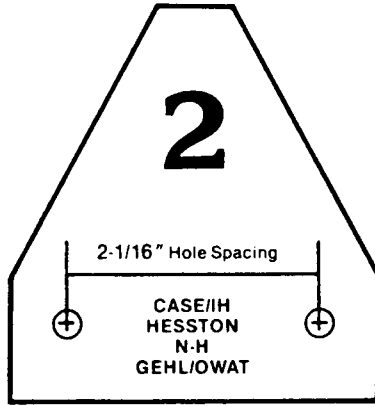
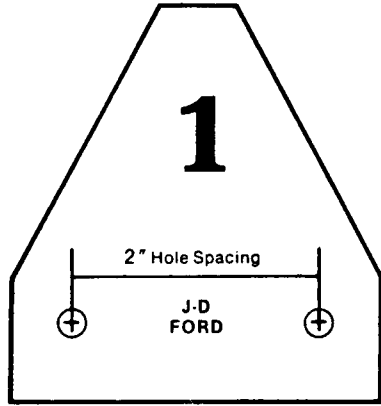

**MATCH YOUR SECTION HERE**

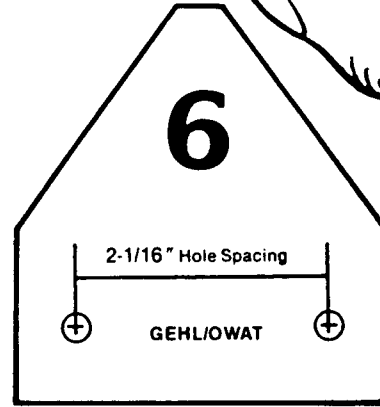
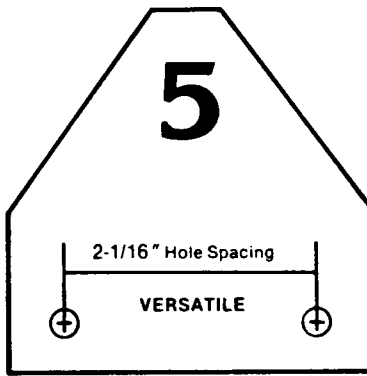
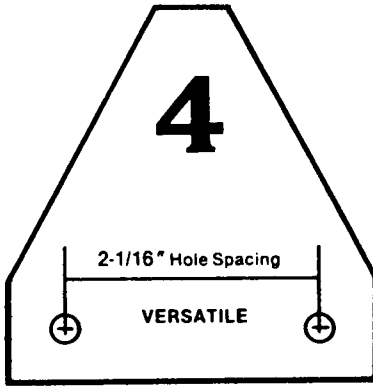

**SHAPE #1**

ORDER NUMBER	TYPE OF SECTION	RIVET** SIZE	REPLACEMENT FOR	
211-102	H SM	9/16 OH	FORD	141197
211-022	H US	9/16 OH	J-D	27030H
			FORD	141198
212-082	H US PL	9/16 OH	J-D	H21530
212-242	H TS PL	9/16 OH	J-D	E45996
211-021	XH US	5/8 OH	J-D	E76373
212-081	XH US PL	5/8 OH	J-D	E76371
212-241	XH TS PL	5/8 OH	J-D	E76370

**SHAPE #3**

ORDER NUMBER	TYPE OF SECTION	RIVET** SIZE	REPLACEMENT FOR	
211-223	R US	9/16 OH	M-F	1041472M1
212-103	R US PL	9/16 OH	M-F	160262M1
			N-H	276617
			MACDON	K-7253-1
			WHITE	895268L
212-412	H TS PL	5/8 OH	M-F	1046776M1
			N-H	275521
			MACDON	K-22268-1
212-091	XH US PL	5/8 OH	M-F	669807M1
211-411	XH TS	5/8 OH	MACDON	-K-34390-1

**SHAPE #2**

ORDER NUMBER	TYPE OF SECTION	RIVET** SIZE	REPLACEMENT FOR	
211-003	R US	9/16 OH	CO-OP	1145
			CASE/IH	826723C1
			N-H	67630
212-063	R US PL	9/16 OH	CO-OP	1471
			CASE/IH	457606R2
			N-H	604800
212-003	R TS PL	9/16 OH	HESSTON	049213
			N-H	604921
212-012	H TS PL	9/16 OH	HESSTON	049254
			N-H	604921H
211-011	XH SM	5/8 OH	CASE/IH	826724C1
			N-H	26622
211-001	XH US	5/8 OH	CASE/IH	826722C1
			N-H	29875
			N-I	OU577HS
			GEHL/OWAT	340-32049
212-061	XH US PL	5/8 OH	GEHL	060635
			CASE/IH	457607R2
			N-H	706226
211-211	XH TS	5/8 OH	CASE/IH	826720C2
			GEHL/OWAT	340-32015
212-001	XH TS PL	5/8 OH	CASE/IH	596321R3
			HESSTON	700705300

**SHAPE #4**

ORDER NUMBER	TYPE OF SECTION	RIVET** SIZE	REPLACEMENT FOR	
211-053	R TS	9/16 CTSK	VERSATILE	SW1616
212-213	R TS PL	9/16 CTSK	VERSATILE	SW1616CR

**SHAPE #5**

ORDER NUMBER	TYPE OF SECTION	RIVET** SIZE	REPLACEMENT FOR	
411-083	R TS	9/16 CTSK	VERSATILE	SW1776
412-063	R TS PL	9/16 CTSK	VERSATILE	SW1776CR

**SHAPE #6**

ORDER NUMBER	TYPE OF SECTION	RIVET** SIZE	REPLACEMENT FOR	
411-132	H TS	9/16 OH	GEHL/OWAT	340-32041
412-011	XH TS PL	5/8 OH	N-H	694723

**COMBINE**  
**-SICKLE SECTIONS-**  
**MATCH YOUR SECTION HERE**

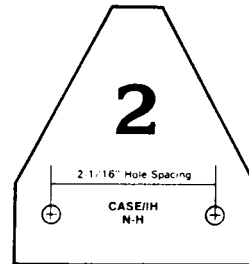
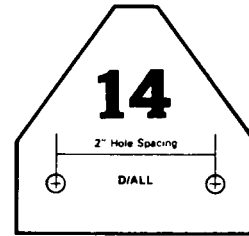
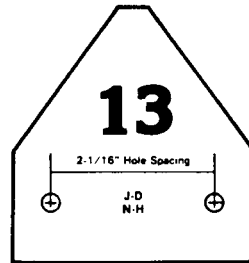
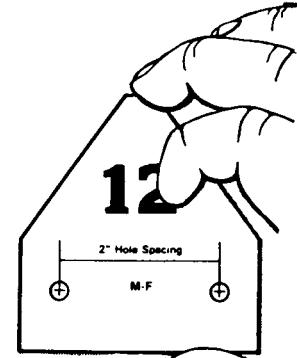
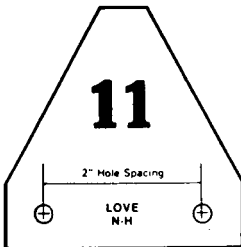
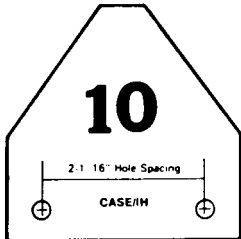
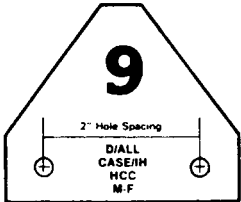
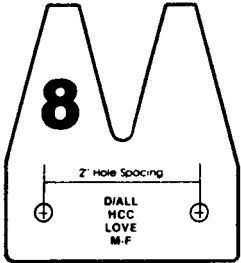
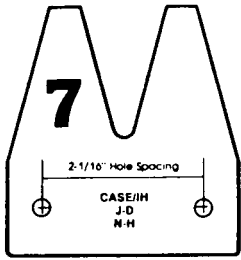

**SHAPE #7**

ORDER NUMBER	TYPE OF SECTION	RIVET** SIZE	REPLACEMENT FOR
622 091	XH TS	5/8 OH	CASE/IH, HESS, N-H, HAY EQUIPMENT N-H 848092 N-H 848093 UNV DC7000
622 021	XH TS PL	5/8 OH	
622 051	XH TS	5/8 BOLT	
622 031	XH TS PL	5/8 BOLT	

**SHAPE #8**

ORDER NUMBER	TYPE OF SECTION	RIVET** SIZE	REPLACEMENT FOR
622 241	XH TS	5-8 OH	J-D HAY EQUIPMENT: M-F 1904915M2 D/IALL 71353125 LOVE L212A LOVE L212C M-F 1904914M2 UNV DC6000
622 101	XH TS PL	5-8 OH	
622 041	XH TS	5-8 BOLT	
622 011	XH TS PL	5-8 BOLT	

**SHAPE #9**

ORDER NUMBER	TYPE OF SECTION	RIVET** SIZE	REPLACEMENT FOR
112-001	XH TS PL	5-8 CTSK	D/IALL 71176531 CASE/IH 179736C1 M-F 1053209M1 HCC 277444

**SHAPE #10**

ORDER NUMBER	TYPE OF SECTION	RIVET** SIZE	REPLACEMENT FOR
412-071	XH TS PL	5-8 OH	CASE/IH 634794R2

**SHAPE #11**

ORDER NUMBER	TYPE OF SECTION	RIVET** SIZE	REPLACEMENT FOR
212-121	XH TS PL	5-8 CTSK	N-H 271981CR LOVE L192DCR

**SHAPE #12**

ORDER NUMBER	TYPE OF SECTION	RIVET** SIZE	REPLACEMENT FOR
412-032	H TS PL	5-8 OH	M-F 146503M2

**SHAPE #13**

ORDER NUMBER	TYPE OF SECTION	RIVET** SIZE	REPLACEMENT FOR
411-022	H TS	5-8 OH	J-D H84413
412-021	XH TS PL	5-8 OH	J-D H130478 N-H 134104

**SHAPE #14**

ORDER NUMBER	TYPE OF SECTION	RIVET** SIZE	REPLACEMENT FOR
411-073	R TS	5-8 BOLT	D/IALL 71116939
422-003	R TS PL	9-16 OH	D/IALL 71122784
411-051	XH TS	5-8 BOLT	D/IALL 71351135
412-051	XH TS PL	5-8 OH	D/IALL 71135135

**SHAPE #2**

ORDER NUMBER	TYPE OF SECTION	RIVET** SIZE	REPLACEMENT FOR
212 012	H TS PL	9/16 OH	N-H 604921H
211-211	XH TS	5-8 OH	CASE/IH 828720C2
212-001	XH TS PL	5-8 OH	CASE/IH 598321R3

**KONDEX**

**EXPLANATION OF ABBREVIATIONS**

SICKLE SECTIONS	FASTENERS
<p>H   US   PL</p> <p>SECTION FINISH PL - PLATED FINISH</p> <p>TYPE OF SECTION SM - SMOOTH US - UNDER SERRATED TS - TOP SERRATED</p> <p>SECTION THICKNESS R - REGULAR, 14 GAUGE (.075/.090) H - HEAVY, 12 GAUGE (.095/.110) XH - EXTRA HEAVY, 11 GAUGE (.106/.121)</p>	<p>9/16   OH</p> <p>RIVET HEAD OH - OVAL OR ROUND HEAD CTSK - COUNTERSUNK OR FLAT HEAD</p> <p>BOLT - SPECIAL GRADE 8 KNURLED HEAD</p> <p>LENGTH OF RIVET OR BOLT IN INCHES</p> <p>NOTE: ALL RIVETS ARE #5-1/2 DIAMETER UNLESS MARKED OTHERWISE. #5-1/2 DIAMETER IS 7/32 (.218). BOLTS ARE 7/32 DIAMETER, UNLESS MARKED OTHERWISE, AND ARE INTERCHANGEABLE WITH THE RIVETS (KNIFECLIPS USUALLY NEED TO BE CHANGED)</p>

# KONDEX

# GLOSSARY

For Part Identification Only!  
See previous pages for Order No. & Application.

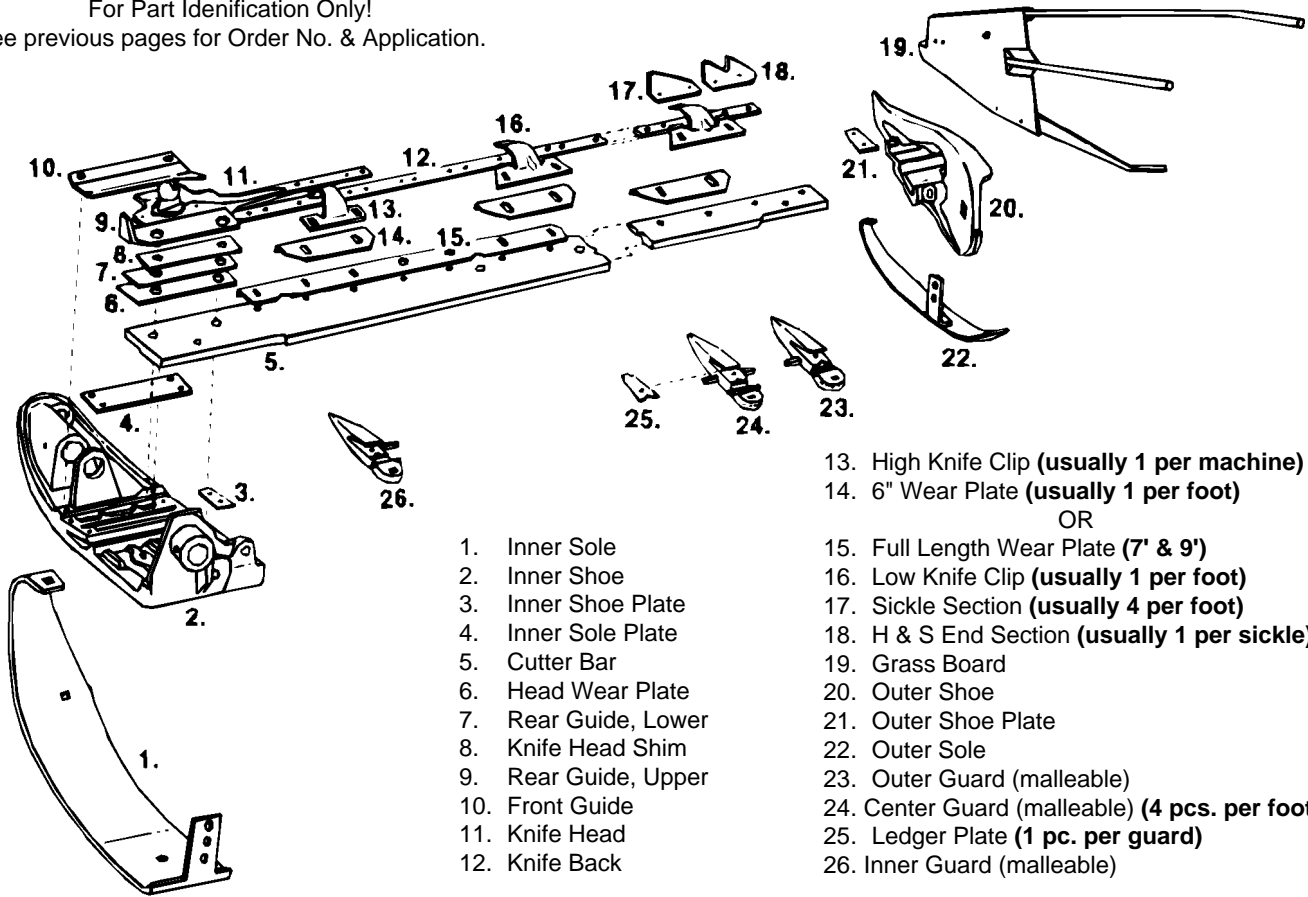

## PITMAN ASSEMBLY

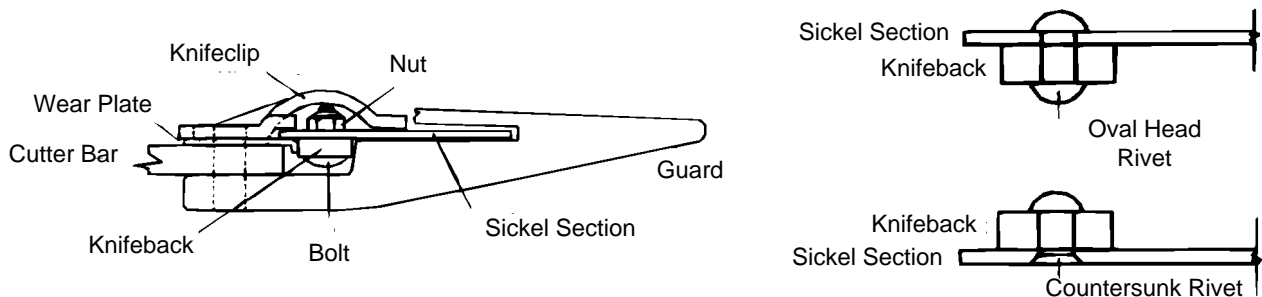
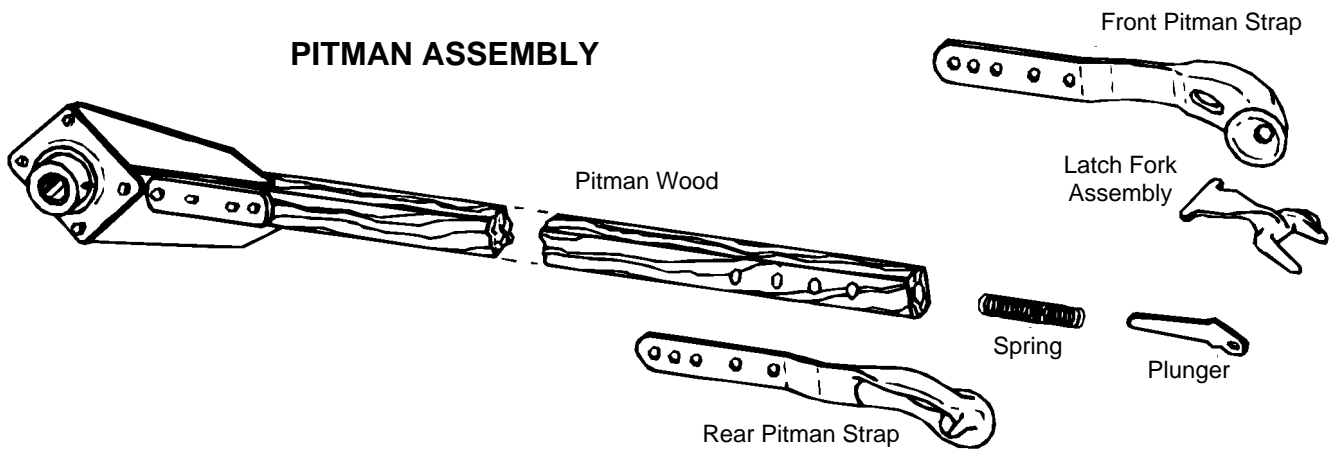



### Kondex Cutting Parts Price List (CONTINUED)

See Pages 14 thru 40 For Applications & Specifications

Number	Units	List	Number	Units	List	Number	Units	List	Number	Units	List
904-010	..... E	\$37.70	904-501	..... E	\$10.94	920-118	..... E	\$3.40	920-222	..... E	\$26.92
904-020	..... E	\$12.06	904-502	..... E	\$16.57	920-119	..... E	\$4.18	920-223	..... E	\$66.60
904-021	..... E	\$9.55	904-504	..... E	\$14.32	920-126	..... E	\$3.50	920-246	..... E	\$3.35
904-022	..... E	\$9.30	904-508	..... E	\$20.34	920-127	..... E	\$4.76	920-314	..... E	\$42.34
904-023	..... E	\$9.30	904-510	..... E	\$21.85	920-128	..... E	\$45.15	920-329	..... E	\$39.27
904-024	..... E	\$22.48	904-511	..... E	\$19.84	920-129	..... E	\$46.80	920-330*	..... E	\$40.74
904-025	..... E	\$11.80	904-513	..... E	\$13.30	920-130	..... E	\$6.54	920-333	..... E	\$21.20
904-026	..... E	\$9.29	904-515	..... E	\$80.70	920-136	..... E	\$4.11	920-334	..... E	\$5.50
904-027	..... E	\$9.29	904-518	..... E	\$37.63	920-144	..... E	\$75.80	920-335	..... E	\$1.80
904-028	..... E	\$27.02	904-519	..... E	\$44.68	920-145	..... E	\$53.55	920-343	..... E	\$8.20
904-030	..... E	\$10.14	904-525	..... E	\$15.33	920-146	..... E	\$62.37	920-366	..... E	\$3.55
904-031	..... E	\$9.30	904-526	..... E	\$15.33	920-150	..... E	\$38.83	920-386	..... E	\$1.25
904-040	..... E	\$20.72	904-527	..... E	\$12.30	920-151	..... E	\$66.25	920-387	..... E	\$1.25
904-041	..... E	\$10.61	904-528	..... E	\$14.08	920-152	..... E	\$46.37	920-433	..... E	\$33.22
904-042	..... E	\$35.40	904-529	..... E	\$14.79	920-154	..... E	\$63.05	920-434	..... E	\$31.70
904-109	..... E	\$5.30	904-534	..... E	\$13.82	920-155	..... E	\$44.27	920-436	..... E	\$28.37
904-110	..... E	\$6.53	920-103	..... E	\$12.54	920-193	..... E	\$22.25	920-437	..... E	\$40.46
904-500	..... E	\$14.19	920-105	..... E	\$15.00						

\* Denotes Non-Stock Item      DEALER SCHEDULE THIS PAGE.....152      Prices Subject To Change Without Notice.

You Can *Rely* On  
*Central Supply!*

Over 95% Of All Orders Ship The Same Day!

Call 1-800-444-8666



## STERN HOLD-DOWN CLIPS

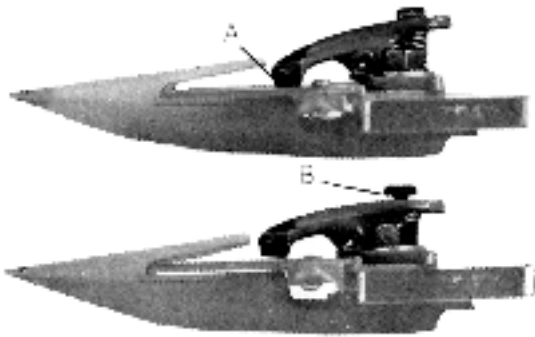

Fits mowers, combines and all sickle bar applications. Field tested for four years.

Save on breakage and wear on sickle blades. Save sharpening 50% with Stern Hold-Down Clips.

Comes with a replaceable plastic wear strip that takes all the wear (A). This clip has a 3 year field test.

Not to be confused with other clips without the proper means to control the pressure on blades and to conserve excess wear on plastic by means of a bolt setting (B).

Also is the method to release tension on sickle section for quick removal of sickle section by turning bolt 1/4 turn R or L.

### 1000 SERIES FOR MOWERS, COMBINES, WINDROWERS

No.		Each
1016	Low Arch with 7/16" Bolt Hole	\$21.75
1026	High Arch with 7/16" Bolt Hole	22.30
1048	High Arch with 3/8" Bolt Hole	22.90
1050	Plastic Wear Strip for Above	1.85

### PARTS FOR 1000 OR 2000 SERIES

1052	Adjustment Bolt	2.35
1061	T Nut for 1052 Adjustable Bolt	1.50
1063	Tension Spring	1.75

**Note** --- Use 1026 or 2026 to provide high clearance on the sickle bar section next to headend drive.

Dealer Schedule.....152

## S/V RIVET TOOL

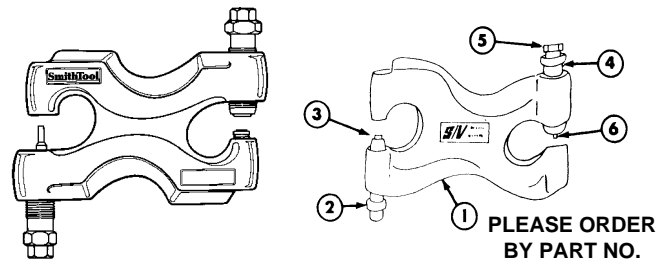

Removes and replaces **BOTH** standard round-head **AND** countersunk rivets.

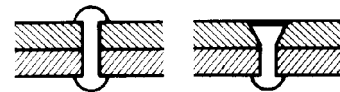

New 2-way reversible anvil insert gives this tool the capability of replacing both types of rivets quickly and easily. Ideal tool for the operator who has several machines with varying sickle section fasteners. Narrow body design fits all sickles including new Tiger Tooth sections. Packed in clamshell complete with instructions.

No.		Each
R-3030	Rivet Tool	\$140.10

### REPAIR PARTS FOR S/V RIVET TOOLS

Part No.	Ref.	Description	Price
R-3033	1	Body Casting	\$165.20
R-1623	2	Riveter Screw	15.49
R-1813	3	Riveter Sleeve	15.49
R-1814	4	Punch Sleeve	18.59
R-2000	5	Punch Screw	11.36
R-5002	6	Punch (5/16" Diameter)	11.36

R-3035	Anvil w/O-Ring (R-3030)	5.14
--------	-------------------------	------

Dealer Schedule	Tools	203
	Parts	152

*Centralize with  
Central Supply*

Call Toll-Free:

**1-800-444-8666**

or Fax Toll-Free:

**1-800-342-7252**

## S/V BOLT-ON TOOL

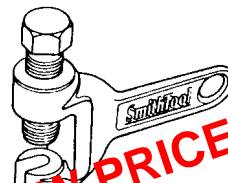

Compact, Heavy Duty tool designed specifically to press bolts into knife backs.

No.	Description	Price
S-2008	Bolt-On Tool	\$68.15
S-2003	Drive Screw	9.50

Dealer Schedule:	Tools	203
	Parts	152



# Crop-Saver Guards

Heavy-Duty Case-Hardened One-Piece Construction

BT-260 Two Piece

Universal Mower Guard

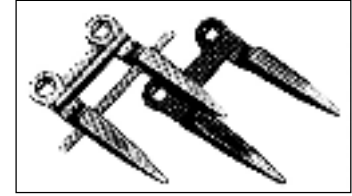

Buchanan Number		O.E.M. Number	Herschel Number	Wt.	Price Each
<b>ALLIS CHALMERS</b>					
BC-225	All Combines-Gleaner 1955 & After	1116504/71341601	FC-68-2	1.06	\$11.90
BU-231	All Floating Bars	1176532/1320143	FC-89-2	1.81	14.85
BU-226	All Combines w/Flex Head	1341601		1.06	13.70
<b>CASE</b>					
BT-260*	Windrower	FH049270	FT-77-2	1.38	14.05
BT-261	Low Plate	F38123/F35005	FT-78-2	.50	8.20
BT-262	High Plate	F35006	FT-79-2	.50	12.65
BC-266	Case/IH Combine #1020	1305195C1	FC-60-4	1.40	9.65
BU-245*	Windrowers # 950, 955, 1050	FH049239	FS-66-2	1.69	13.00
BU-245H <sup>3</sup>	Windrowers # 950, 955, 1050	FH049239	FS-66-DH	1.69	15.30
<b>COCKSHUTT</b>					
BU-235*	Windrower 501, 502, 503	895744L	FS-73-2	1.63	13.45
<b>JOHN DEERE</b>					
BC-240A <sup>4</sup>	All Combines (2-Prong)	75386/61954	FC-62-2A	1.13	10.75
BC-340	All Combines (3 Prong)	H25603	FC-62-3	1.50	18.00
BU-220*	Windrower, Mower 250 & 350	E48093, E52667	FS-82-2	1.63	14.75
BU-221*	Mower Conditioners (X-Heavy Substitution)	E62000	FS-84-2A	1.76	16.25
<b>FERGUSON</b>					
BU-295*	Mowers		FS-64-2	1.81	15.05
<b>FORD</b>					
BU-295*	All Ford Mowers - - All 2 Prong Except 505		FS-64-2	1.75	15.05
BU-280*	Mower Conditioner 535	290385	FS-72-2	1.63	14.75
BU-205*	Mower Conditioner 536	110-10657	FS-80-2	1.75	14.60
BU-206*		110-32327/110-32342	FS-92-2	1.78	15.20
BU-210	Mower Conditioner 538 (1979)	483500R3	FS-85-2	1.80	13.90
<b>GEHL</b>					
BU-220*	Mowers 770, 880, 1070, 1090	072057/059827	FS-82-2	1.63	14.75
BU-250*	Mower Conditioner Stub Guard				
	770, 880, 1070, 1090	049312	FS-86-2	1.16	12.50
BU-270*	Mower Conditioner MA206A, HK108, HK440	044779	FS-65-2	1.81	13.55
<b>HART CARTER</b>					
BU-231	Floating Header	234006/232155	FC-89-2	1.44	14.85
<b>HESSTON</b>					
BU-245*	All Windrowers	049239/748178	FS-66-2	1.69	13.00
BU-245H <sup>3</sup>	All Windrowers	700700845	FS-66-DH	1.69	15.30

(Hesston Continued On Next Page)

NOTE: \* Raised Trash Bar, <sup>3</sup> "H" Induction Hardened

Dealer Schedule This Page.....152



## Crop-Saver Guards

Heavy-Duty Case-Hardened One-Piece Construction

BT-260 Two Piece

Universal Mower Guard

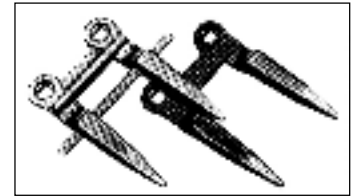

Buchanan Number		O.E.M. Number	Herschel Number	Wt.	Price Each
<b>HESSTON (Continued From Preceding Page)</b>					
BU-250*	Windrowers & Mower Conditioners Stub Guard	049312	FS-86-2	1.16	\$12.50
BU-215A*	All Windrowers 1970 & After	049239/049270	FS-81-2	1.75	12.65
BU-215H <sup>3</sup>	All Windrowers 1970 & After	049239/049270	FS-81-DH	1.75	14.50
BT-260*	All Windrowers 1970 & After	049270	FT-77-2	1.38	14.05
BT-261	Low Plate	6213789/6108500	FT-78-2	.50	8.20
BT-262	High Plate	6108518	FT-79-2	.50	12.65
<b>INTERNATIONAL HARVESTER</b>					
BC-266	IH/Case Combine #1020	1305195C1	FC-60-4	1.40	9.65
BU-231	All Floating Bars	179775C1	FC-89-2	1.41	14.85
BU-299	Floating 810 Flex	1307299C1, 1307299C2		1.81	14.80
BC-265	All Combines	633098R1	FC-69-2	1.38	13.80
BU-210*	Mowers, 1000-Series; Swathers, 230 & 210; Forage Harvester 650 & 655; Mower Conditioner 990	483500R3	FS-85-2	1.80	12.50
BU-250*	Windrowers - - - Stub Guard	Optional	FS-86-2	1.16	12.50
BU-270*	Windrower 175 & 200, 820 & 1010 Flex Headers	613838R1	FS-65-2	1.81	13.55
BU-235*	Windrower 75	K8420S	FS-73-2	1.63	13.45
BT-260*	Windrower (Except 75)	823025C1	FT-77-2	1.38	14.05
BT-261	Low Plate	823026C1	FT-78-2	.50	8.20
BT-262	High Plate	823027C1	FT-79-2	.50	12.65
<b>KOSCH</b>					
BU-270*	Mowers	All	FS-65-2	1.81	13.55
<b>LOVE</b>					
BU-275	Floating Header	LB208/LB214	FC-90-2	1.31	12.60
<b>MASSEY-FERGUSON</b>					
BU-280*	Hay Tender 81	1036339M1	FS-72-2	1.63	14.75
BC-240A	All Combines (Ridgid Bar)	228392M1 & M2	FC-62-2A	1.13	10.75
BC-340	All Combines (3 Prong)		FC-62-3	1.13	18.00
BU-231	Combines - - - Floating Bar 540, 550, 750, 760	105317M1	FC-89-2	1.44	14.85
BU-255*	All Windrowers 34, 36, 44	143240M1	FS-83-2	1.38	16.10
BU-235*	All Windrowers 655	1041468M1	FS-73-2	1.63	13.45
BU-215A*	Mower Conditioners 725, 825, 925	683184M1/683476M1	FS-81-2	1.75	12.65
BU-215H <sup>3</sup>	Mower Conditioners 725, 825, 925	683184M1/683476M1	FS-81-DH	1.75	14.50
<b>MINNEAPOLIS MOLINE</b>					
BU-235*	Windrowers 100 & 101	895744L	FS-73-2	1.63	13.45

(Crop-Saver Guards Continued On Next Page)

NOTE: \* Raised Trash Bar, <sup>3</sup> "H" Induction Hardened

Dealer Schedule This Page.....152

**Call Central Supply & Rubber Co. TOLL-FREE 1-800-444-8666**



# Crop-Saver Guards

Heavy-Duty Case-Hardened One-Piece Construction

BT-260 Two Piece

Universal Mower Guard

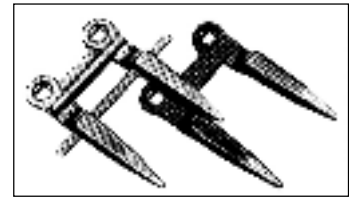

Buchanan Number		O.E.M. Number	Herschel Number	Wt.	Price Each
<b>NEW HOLLAND</b>					
BU-245*	All Windrowers	65327	FS-66-2	1.69	\$13.00
BU-245H <sup>3</sup>	All Windrowers	65327	FS-66-DH	1.69	15.30
BU-250*	Windrowers & Mower Conditioners- Stub Guard	257634	FS-86-2	1.16	12.50
BU-275*	Combines - - - Floating Bars	271971/273846	FC-90-2	1.81	12.60
BU-215A*	All Windrowers	653327	FS-81-2	1.75	12.65
BU-215H <sup>3</sup>	All Windrowers	858778/219191/653327	FS-81-DH	1.75	14.50
BT-260*	Tie Guard		FT-77-2	1.38	14.05
BT-261	Low Plate		FT-78-2	.50	8.20
BT-262	High Plate		FT-79-2	.50	12.65
BC-240A	All Combines (Ridgid Head)	134024	FC-62-2A	1.13	10.75
BU-218*	All Mowers	219190	FS-93-2	1.72	13.95
<b>NEW IDEA</b>					
BU-280*	Mow/Ditioner 290	290385	FS-72-2	1.63	14.75
BC-240A	Combine Platform 711, 713, 715	714611	FC-62-2A	1.13	10.75
<b>OLIVER</b>					
BU-235*	Windrowers 501, 502, 503	895744L	FS-73-2	1.63	13.45
<b>OWATONNA</b>					
BU-205*	All Windrowers Prior To 1979	110-10657	FS-80-2	1.75	14.60
BU-206*	Windrowers & Mower Conditioners 1979 & After	110-32342/110-32327	FS-92-2	1.78	15.20
<b>VERSATILE</b>					
BU-290*	All Windrowers	SW1605	FS-67-2	1.44	11.95
<b>WHITE</b>					
BC-310A	Combines (3/8" Bolt) 7300, 8600, 8700, 8800, 8900 & 9700	31-1713400	FC-94-4	1.23	13.60
BC-310B	Combines (7/16" Bolt) 7300, 8600, 8700, 8800, 8900 & 9700	31-1713400	FC-94-4	1.23	13.60
BC-311	Combines 7300, 8600, 8700, 8800, 8900, 9700 Top Plate	31-1794160	FC-95-2	1.00	12.50
BU-231	Combine (Floating Bar)	31-2749417	FC-89-2	1.81	14.85
BU-235	Windrowers 501, 502, 503	895744L	FS-73-2	1.63	13.45
<b>UNIVERSAL GUARDS FOR ALL MOWERS EXCEPT FORD</b>					
BU-270*	Two Prong		FS-65-2	1.81	13.55
BT-260*	Tie Guard		FT-77-2	1.38	14.05
BT-261	Low Plate		FT-78-2	.50	8.20
BT-262	High Plate		FT-79-2	.50	12.65

NOTE: \* Raised Trash Bar, <sup>3</sup> "H" Induction Hardened

Dealer Schedule This Page.....152

DUE TO MARKET CONDITIONS ALL PRICES ARE SUBJECT TO CHANGE WITHOUT NOTICE.

# Kosch

"Clean Sweep" All Steel Grassboard

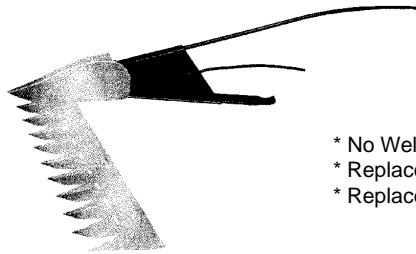

- \* No Welding
- \* Replaceable Rods
- \* Replaceable Runner

No.	Description	Price
KA161 .....	Kosch Grassboard .....	\$36.00

Dealer Schedule: Less Than 5 ..... 152  
 5 or more ..... 203

# RUBBER RAKE TEETH

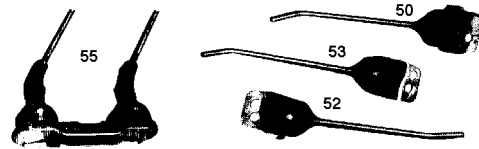

**Model 50** - The Ribbed Headed Single is designed for round bar parallel bar rakes. To replace Allis Chalmers, IHC, John Deere, New Idea and others.

**Model 52** (Left, to replace #65668-L) and **Model 53** (Right, to replace #139041-R) are New Holland brands, ribbed and headed.

**Model 55**, Ribbed Headed Teeth for Wheel Rakes. Replaces Darf, Rola-Rake, Farmhand, New Idea and others.

**Model 65** Fits Vermeer Baler #27997-001

No.	Description	Each
RT-50 .....	Rubber Rake Tooth .....	\$3.00
RT-52L ....	Rubber Rake Tooth .....	4.05
RT-53R....	Rubber Rake Tooth .....	4.05
RT-55 .....	Rubber Rake Tooth .....	10.35
RT-65 .....	Rubber Rake Tooth .....	7.91

Dealer Schedule.....152

**Centralize**  
 Your Buying With  
**Central Supply!**

**We Ship  
 Over 95%  
 Of Our Orders  
 The Same Day!**

To Order Call Toll-Free:  
**1-800-444-8666**

**Fax Toll-Free 1-800-342-7252**

## Central Trash Guards

**For Deere, Kinze, & White Planters**

Prevents corn stalks, lumps and other trash from plugging press wheels and slowing down planting.

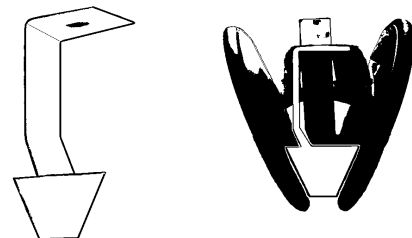

**Fits: John Deere 7000 & 1700 series, Kinze Planters, White 6000 series.**

Guard can be easily mounted to the front of the press wheels on corn planters. The John Deere 7200 and 7300 models need a 1/2" hole drilled exactly 1-1/4" ahead of the slot. 7/16"x1-1/2" Gr.5 Carriage Bolt w/Nut, Flat Washer & Lock Washer Required. (NOT FURNISHED)

Order No.	Price	
YQ14 .....	Trash Guard.....	\$14.30

Dealer Schedule.....233

# BEAL FLAIL SHREDDER COMPONENTS

Heat-Treated - Manufactured To OEM Specifications - High Quality



Adapter  
6024-710-30

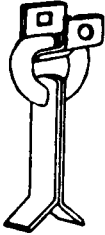

D-Ring  
6023-705-30



Knife  
(2-Required)  
6021-604-30

Adapter  
6024-710-30

Square Ring  
6901-502-30

Cup Knife  
6022-718-30

U-Bar\*  
6024-743-30  
\*For some older models Brady  
Cup Knife Assemblies require  
#6024-699-30 U-Bar instead of  
#6024-743-30 Adapter shown  
above



U-Bar  
6024-737-30

D-Ring  
6023-704-30

Knife (2-Required)  
6021-875-30

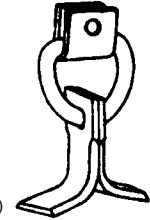

BRADY  
Sideslicer Knives

BLAZER, BRADY  
Cup Knife

LUNDELL  
Cup Knife

SUNMASTER/ARTSWAY  
Cup Knife

JOHN DEERE  
Sideslicer Knife

Order No.	OEM No.	Description	Dimensions	Wt.	Price
<b>John Deere</b>					
6021-875-30	E48308	Sideslicer Knife (2-Required)	5/16"x2-1/2"x5-1/4" 3/4" hole	1.17	\$11.05
6023-704-30	E48307	D-Ring	9/16"	.62	6.60
6024-737-30	E48305	U-Bar	1/4"x2"x2-1/2"	.66	8.30
<b>Balzer</b>					
6021-604-30	12357	Sideslicer Knife (2-Required)	1/4"x2"x5-3/8" 1/2" hole	.73	10.85
6023-705-30	12356	D-Ring	17/32" material	.39	4.50
6024-710-30	12355	Pivot	1/4"x1-5/8"x2" 1/2" hole	.52	5.75
6022-718-30	12297	Cup Knife 4-1/2"	1/4"x2-1/2"x4-1/2" 1/2" hole	.81	10.55
6024-743-30	12296	U-Bar	1/4"x1-1/2"x2-3/4" 1/2" hole	.52	7.45
6901-502-30	12295	Square Ring	17/32" material	.41	4.90
<b>Bush Hog</b>					
6021-701-30	4725130273	Sideslicer Knife (2-Required)	1/4"x2"x4-1/2" 3/4" hole	.61	10.30
6023-700-55	4725130272	D-Ring	17/32" material	.61	5.66
6024-700-30	4725130271	U-Bar	1/4"x2"x3-1/4" 1/2" hole	.86	9.55
<b>Brady/Fox</b>					
6021-604-30	65143	Sideslicer Knife (2-Required)	1/4"x2"x5-3/8" 1/2" hole	.73	10.85
6023-705-30	65142	D-Ring	17/32" material	.39	4.50
6024-710-30	65141	Pivot (Newer Models)	1/4"x1-5/8"x2" 1/2" hole	.52	5.75
6022-718-30	1694	Cup Knife 4-1/2"	1/4"x2-1/2"x4-1/2" 1/2" hole	.81	10.55
6024-743-30	65227	U-Bar	1/4"x1-1/2"x2-3/4" 1/2" hole	.52	7.45
6901-502-30	65144	Square Ring	17/32"	.42	4.90
6024-699-30	65317	U-Bar Adapter (Older Models)	1/4"x1-1/2"x2-3/4" 1/2" hole	.52	7.30
<b>Sunmaster/Artsway 88</b>					
6022-708-97**	18205-0	Cup Knife 5" Curled Eye Dura Face	1/4"x2-1/2"x5"	1.60	30.10
<b>Lundell</b>					
6022-710-30	21076A	Cup Knife	1/4"x2-1/2"x4-1/2" 3/8" hole	.83	10.65
6022-710-97	219761	Cup Knife 4-1/2" Dura Face	1/4"x2-1/2"x4-1/2" 3/8" hole	.81	20.60

\*\* 5" & 6" Artsway Knives also fit Case/IH Model 50 Flair Shredders.

Dealer Schedule.....152

# 1-800-444-8666

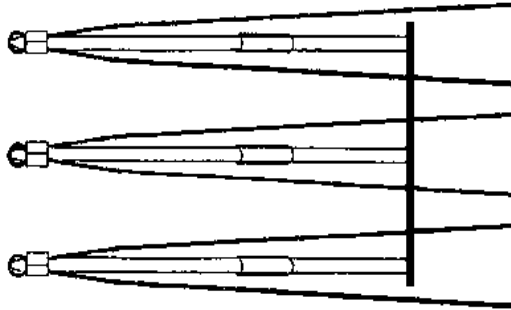

## Flexo Guard ABM-D-3F

**This is a special 3-Point bolt on guard to be used on John Deere Flex Heads only with 4" center.**  
This Flexo Guard will fit on O.E.M. guard #H213398JD, #H213507JD, H229538JD, and #H229537JD

### Installation Instructions

1. Start with one exposed guard at the left of your platform.
2. Place the 3 point guard on the next 3 guard points and bolt into place and continue to cover the exposed points at the end of the platform.
3. Take one of the 3 point guard sections and saw it into 3 pieces. Placing the left piece on the left side of the platform and the right side on the right side of the platform to cover the exposed points at the end of the platform.
4. This completes the assembly as needed to cover all guard points.
5. Install the tine wires in each of the flexo guard points tapping in each until flush with the end. Then spread the wires approximately 4" to 5" at the extreme points.

\*\* You may need longer bolts to compensate for the thickness of the tab on the guard. \*\*

Order No.	Description	Price
ABM--D-3F .....	ABM 3 pt. Flexo Guard .....	\$57.80
	Priced with #11X-3202F Ex-Long Wire	

Note: Use 1 #ABM-D-3F per 1 foot.

Dealer Schedule.....203

**Need it FAST? Over 95% of all orders Ship The Same Day!**

### ELLIPTIC HEAD PLOW SCREWS For Danish Tine Sweeps



Order No.	Size	Wt./C	Ctn.	Per C
PSEL-06-0108 .....	3/8"x1-1/2" ....	4.85 lbs. ....	100 ...	\$41.04

Dealer Schedule:

Full Carton.....204 Broken Carton.....202

### Sweeps for Danish Style "S" Tine Cultivators



Order No.	Size	Wt. Lbs.	Bundle	Price
6021-849-38 .....	4" x 3/16" .....	.75 .....	10 .....	\$6.12
6021-983-38 .....	2-3/4" x 1/4" .....	.73 .....	10 .....	4.86
6021-984-38 .....	4" x 1/4" .....	.79 .....	10 .....	6.15

Dealer Schedule.....152

**Centralize**  
*Your Buying With*  
**Central Supply!**

**TOLL-FREE FAX 1-800-342-7252**

# ABM Flexo Guards

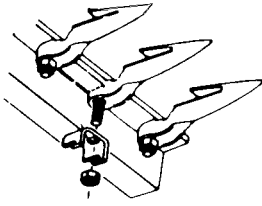

Explanation of FLEXO GUARD set composition

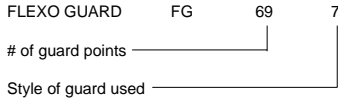

# Grain Saver Boot Attachment

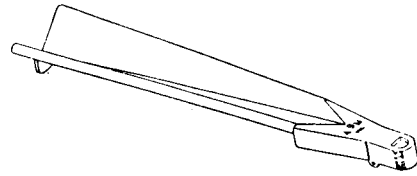

The Grain Saver Boot attaches to the Flexo Guard Point Section and is designed to catch crop loss that is caused by shatter and drop. The crop that is normally lost, is recovered in the Boot and transferred to the Platform.

Save more bushels of sorghum, soybeans, sunflowers and many other crops. Also designed to work with all Bolt On Sickles Sections to prevent Tine wire problems.

## Flexo Guard Application Guide

### DUETZ / ALLIS CHALMERS / GLEANER

Set No.	Width	Lbs	Set No.	Width	Lbs
FG-387	10'	33	FG-747	19'	55
FG-467	12'	35	FG-787	20'	58
FG-507	13'	38	FG-867	22'	63
FG-547	14'	41	FG-907	23'	66
FG-587	15'	44	FG-947	24'	69
FG-627	16'	46	FG-1127	27'	81
FG-667	17'	49	FG-1207	30'	88
FG-707	18'	52			

**NOTE** - - Series 3 Integral Flex Header has no fit available. For guard #71341601 use C-clasp & H-4 clip. For guard #1116504 use C-clasp & H-3 clip. Most other Allis Chalmers guard sections use C Clasp & H Clips. Bolt on sections must use Grain Boot Attachment.

### JOHN DEERE

Set No.	Width	Lbs	Set No.	Width	Lbs
FG-457	12'	34	FG-737	19'	54
FG-497	13'	37	FG-777	20'	58
FG-537	14'	40	FG-857	22'	63
FG-577	15'	43	FG-937	24'	68
FG-617	16'	46	FG-997	25'	75
FG-697	18'	51	FG-1177	30'	86

**NOTE** - - Headers equipped w/guard #H-75386, H-113571 or H-145791 use C-clasps and H-3 clips. Headers equipped w/guard #H-61954 & H-153719 use C-2 clasps and H-3 clips. Most other John Deere guard sections use C clasp and H clips. Bolt on sections must use Grain Boot.

### CASE IH / INTERNATIONAL HARVESTER

Set No.	Width	Lbs	Set No.	Width	Lbs
FG-477	12'	41	FG-717	18 & 18-1/2'	53
FG-497	13'	37	FG-797	20 & 20-1/2'	58
FG-537	14'	40	FG-877	22 & 22-1/2'	68
FG-597	15 & 15-1/2'	44	FG-937	24'	68
FG-637	16 & 16-1/2'	47	FG-1007	25'	73
FG-677	17 & 17-1/2'	50	FG-1207	30'	88

**NOTE** - - Headers equipped w/guard #633098 or #633240R1 use C-2 clasps and H-3 clips. For guard #1307299 use C-2 clasp & H-4 clip. Model 820 headers w/guard #613838R2 use C-2 clasps and H-3 clips and for every C-2 clasp you will need (1) IHC part #22999 washer and a standard 7/16" bolt. Model 1010 Header will work with C-2 clasps and H-4 clips. Flexo Guards will work on Flex Header ONLY if locked rigid. Bolt on sections must use Grain Boot. Model #1020 has no fit.

### MASSEY-FERGUSON

Set No.	Width	Lbs	Set No.	Width	Lbs
FG-447	11'	38	FG-627	16'	46
FG-467	12'	41	FG-707	18'	52
FG-507	13'	38	FG-787	20'	58
FG-547	14'	41	FG-947	24'	69
FG-587	15'	44	FG-1167	30'	86

**NOTE** - - Flexo Guards will work on Model 9100 Flex Header ONLY if locked rigid. Headers equipped w/guard #BC258AC or #BC240AC use C clasp and H-3 clip. Most other Massey-Ferguson guard sections use C clasp and H clip. Bolt on sections must use Grain Boot Attachment.

### FORD / NEW HOLLAND

Set No.	Width	Lbs	Set No.	Width	Lbs
FG-517	13'	39	FG-757	19'	56
FG-537	14'	40	FG-797	20'	58
FG-597	15'	44	FG-877	22'	68
FG-617	16'	46	FG-937	24'	79
FG-677	17'	50	FG-977	25'	69
FG-697	18'	51	FG-1167	30'	85

**NOTE** - - Headers w/guard #65327 use C-2 clasp and H-3 clip. Header w/guard #134024 use C clasp and H-3 clip. Headers w/guard #695501, #858778, #8653340DS or #219191 use C-2 clasp and H-4 clip. Series 971 will work if locked rigid. Most other New Holland guard sections use C clasp and H clips. Bolt on sections must use Grain Boot.

### WHITE

Set No.	Width	Lbs	Set No.	Width	Lbs
FG-437	11'	41	FG-797	20'	58
FG-517	13'	39	FG-877	22'	68
FG-597	15'	44	FG-957	24'	70
FG-717	18'	53			

**NOTE** - - Direct cut headers w/guard #9510220 use C clasps and H-3 clips. Flexo Guards will NOT fit Kwik Cut Headers w/guard #31-1713400. Most other White guard sections use C clasps and H clips. Bolt on sections must use Grain Boot.

### MACDON

Set No.	Width	Lbs	Set No.	Width	Lbs
FG-1207	30'	86	FG-1447	36'	102

**NOTE** - - Most Macdon guard sections use C-2 clasp and H-4 clips. Bolt on sections must use Grain Boot.

For any header width not listed you need only to count the number of active guard points and come up with a combination of 7 and 8 point Flexo Guard sections to match. (2) Clips and (2) Clasps per section will be required.

**If ordering by Set Number  
be sure to specify which clips and clasps  
are needed for your application.**

**Call Toll-Free  
1-800-444-8666**



## ABM Flexo Guard Sets

Set No.	No. of 8 Pt. Sect. FG-087	No. of 7 Pt. Sect. FG-077	No. of Clips	No. of Clasps
FG-387	3	2	10	10
FG-437	1	5	12	12
FG-447	2	4	12	12
FG-457	3	3	12	12
FG-467	4	2	12	12
FG-477	5	1	12	12
FG-497	0	7	14	14
FG-507	1	6	14	14
FG-517	2	5	14	14
FG-537	4	3	14	14
FG-547	5	2	14	14
FG-577	1	7	16	16
FG-587	2	6	16	16
FG-597	3	5	16	16
FG-617	5	3	16	16
FG-627	6	2	16	16
FG-637	7	1	16	16
FG-667	3	6	18	18
FG-677	4	5	18	18
FG-697	6	3	18	18
FG-707	7	2	18	18

Set No.	No. of 8 Pt. Sect. FG-087	No. of 7 Pt. Sect. FG-077	No. of Clips	No. of Clasps
FG-717	8	1	18	18
FG-737	3	7	20	20
FG-747	4	6	20	20
FG-757	5	5	20	20
FG-777	7	3	20	20
FG-787	8	2	20	20
FG-797	9	1	20	20
FG-857	8	3	22	22
FG-867	9	2	22	22
FG-877	10	1	22	22
FG-907	6	6	24	24
FG-937	9	3	24	24
FG-947	10	2	24	24
FG-957	11	1	24	24
FG-977	6	7	26	26
FG-997	8	5	26	26
FG-1007	9	4	26	26
FG-1127	0	16	32	32
FG-1177	5	11	32	32
FG-1167	11	4	30	30
FG-1207	15	0	30	30

If ordering by Set Number be sure to specify which clips and clasps are needed for your application.

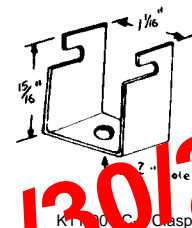
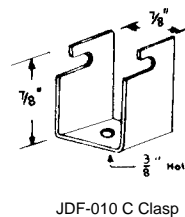
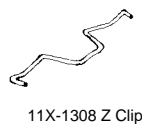
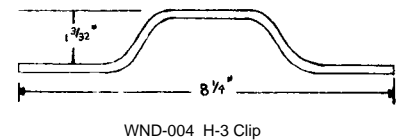
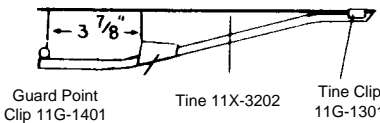
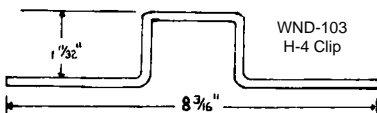
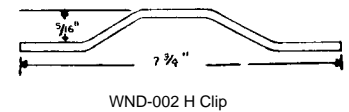
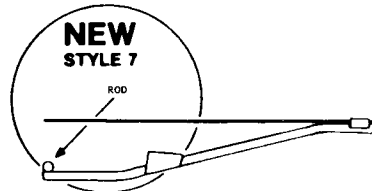
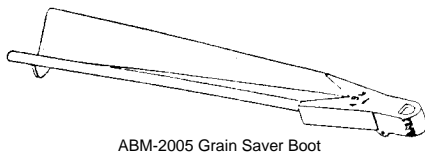

### GRAIN SAVER BOOT ATTACHMENT

No.	Description	Price
ABM-2005	Grain Saver Boot	\$5.95

### OLD STYLE 9 PARTS

No.	Description	Price
11X-1308	Z Clip	\$3.05

No.	Description	Price
FG-077	7 pt. Section with Tines (19" Wide)	\$56.30
FG-087	8 pt. Section with Tines (22" Wide)	61.90
JDF-010	C Clasp	1.80
K11-001	C-2 Clasp	1.80
WND-002	H Clip (Universal)	2.15
WND-004	H-3 Clip	2.15
WND-103	H-4 Clip	2.15
11G-1301	Tine Clip	.80
11G-1401	Guard Point Clip	1.00
11X-3202	Tine	1.75
11X-3202F	Tine, Extra Long	3.35

NEW PRICES AS OF 1/30/2018

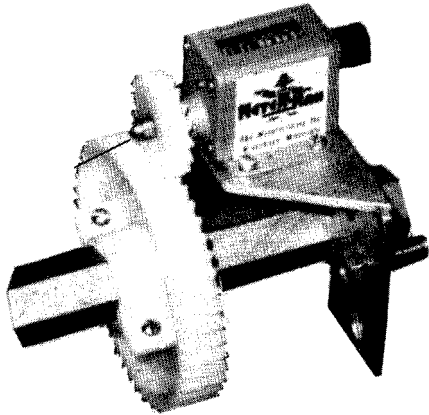

# Meter-Man ACREAGE COUNTERS

## Mechanical Gear Drive Acreage Counter

B&L Manufacturing has introduced a new line of mechanical Acreage Counters for corn and soybean planters. The line features a new aluminum mounting bracket and redesigned counter. The bracket provides constant gear meshing, but allows the counter to count only when the planter is planting. The improved counter displays to 1/1000th of an acre and allows the counter gear to be secured to the counter with a locknut, preventing gear spin-off. The Acreage Counter is now available for more than 150 models of planters.

\* The Acreage Counter is a must for accurate calibration of application rate. Registers in exact acres - only when planter is planting. An inexpensive and dependable system. Constant meshing gears for positive accuracy. Full one year warranty.

Order No.	Description	Price
AC-(Series #) ...	Acreage Counter (Complete) .....	\$96.50
AC-1238 .....	Counter Only .....	59.00
AC-(7T to 35T) ..	Counter Gear .....	3.00
AC-1201 .....	48 Strap Gear .....	18.00
AC-1203 .....	78CL Cluster Gear .....	18.00
AC-1204 .....	48 Hex Strap Gear .....	21.50
AC-1207 .....	34 Strap Gear .....	18.00
AC-1208 .....	38 Hex Strap Gear .....	18.00
AC-1241 .....	4-1/2" Nylon Leaf Bracket .....	21.50
AC-1242 .....	6-1/2" Nylon Leaf Bracket .....	21.50
AC-1243 .....	8-1/4" Nylon Leaf Bracket .....	21.50
AC-1248 .....	Heavy Spring .....	.90
AC-1249 .....	Regular Spring .....	.90
AC-1264 .....	Metal Brkt. (JD 7000, 7100, 7200, 7300)	18.00
AC-1265 .....	Metal Brkt. (IHC 800) .....	18.00
AC-1266 .....	Metal Brkt. (Case-IH 900) .....	18.00
AC-1274 .....	Metal Brkt. (Kinze II, Hiniker, Kinze - Folding Mtd, Dbl. Frame) .....	18.00

Dealer Schedule.....152

### Mechanical Acreage Counter Application Guide:

#### Case-IHC

Series#	Description	Counter Gears	Strap/Cluster Gear	Nylon Brkt.	Metal Brkt.
AC-2000 ....	IHC 455, 456, 466, 658, 56, 58 .....	18, 19, 23, 24, 27, 28, 34, 35 .....	1203 .....	1242	
AC-2001 ....	IHC 400 .....	13 thru 28 .....	1201, 1203 .....	1243	
AC-2004 ....	IHC-800, Case/IH 900, 950 .....	7 thru 32 .....	1204 .....		1266
AC-2005 ....	Black Land Planter .....	33, 34, 35 .....	1207 .....		1265

#### Deutz-Allis

Series#	Description	Counter Gears	Strap/Cluster Gear	Nylon Brkt.	Metal Brkt.
AC-2100 ....	DA385 .....	23, 24, 25, 26, 27, 28, 30, 31, 32, 33, 34, 35 .....	1207T, 1204T .....		1263

#### White

Series#	Description	Counter Gears	Strap/Cluster Gear	Nylon Brkt.	Metal Brkt.
AC-2200 ....	White 5400, 3400 .....	8, 9, 10, 12, 13, 14, 16, 17, 18, 19, 20, 21, 24, 25, 26, 28 .....	1201 .....	1242	1270

#### John Deere

Series#	Description	Counter Gears	Strap/Cluster Gear	Nylon Brkt.	Metal Brkt.
AC-2300 ....	JD493, 493A, 494, 494A, 495, 495A, 1240 .....	24, 25, 31, 32 .....	1203 .....	1241	
AC-2301 ....	JD494AN, 694AN, 694, 695, 694A, 695A, 894A, 1250, 1260, 1280, 1290 .....	13, 14, 15, 17, 18, 19, 20, 21, 22, 26, 27, 30, 31, 32 .....	1201 .....	1241	
AC-2302 ....	JD1300 .....	24, 25, 26, 27, 28, 29, 30, 31 .....	1201 .....	1242	
AC-2305 ....	JD7000, 7100, 7200 & 7300 .....	7 thru 35 .....	1208 .....	shim 1292	1264

#### Kinze & New Idea

Series#	Description	Counter Gears	Strap/Cluster Gear	Nylon Brkt.	Metal Brkt.
AC-2502 ....	Kinze II, 4, 6, 8, & 12-row Kinze 2000, 2100, 2200, 2300, 2400, 2500, 2600 .....	18 thru 23, 25 thru 32, 34, 35 .....	1204 .....		1274

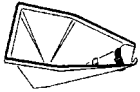

Mini Hopper

## Flex-A-Hopper Straps

Straps grip auger securely.

No.	Description	Price
SMV-ST41 .....	41" Strap f/Square & Mini Hopper..	\$4.12
SMV-ST82 .....	82" Strap f/Round Hopper .....	5.77

Dealer Schedule.....102

*Centralize your buying with Central Supply!*

**Need it FAST?  
We Ship  
Over 95%  
Of Our Orders  
The Same Day!**

To Order Call Toll-Free:  
**1-800-444-8666**

TOLL-FREE FAX 1-800-342-7252

## Grain Gate



**NEW PRICES AS OF 1/10/2018**

No.	Description	Price
SMV-0909 .....	Grain Gate, 9"x9" .....	\$50.50
SMV-0918 .....	Grain Gate, 9"x18" .....	59.20
SMV-1221 .....	Grain Gate, 12"x21" .....	65.45

Dealer Schedule.....102

## Meter-Man Measuring Wheel

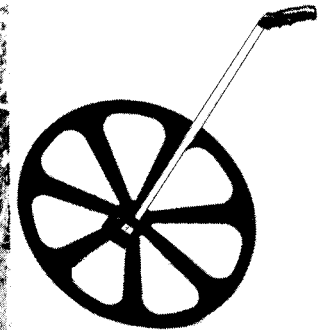

These land measuring wheels make it ideal for easy computation of acreage. The size and the strength of the polystyrene wheel make it a perfect match for rough terrain. Its rugged construction allows for accurate measuring outdoors. The counter reads up to 1000 before resetting.

Order No.	Price
AC-6012 .. 19" Dia. (Feet & Inches) .....	\$106.25

Dealer Schedule.....152

**Centralize**  
*Your Buying With*  
**Central Supply!**

All Prices Are Subject To Change Without Notice

# ELSTON GOPHER GETTER

## EASY, QUICK, LOW COST METHOD FOR POCKET GOPHER CONTROL!

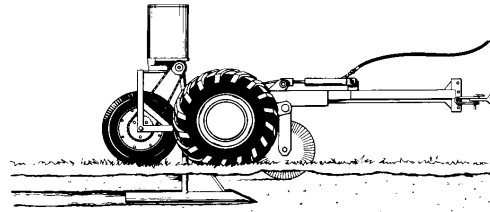
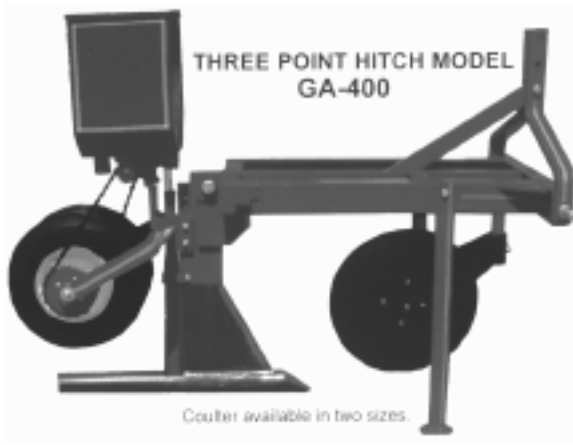

- \* Adjustable depth torpedo (6 to 12") forms artificial runway that intercepts and connects natural pocket gopher runway.
- \* Bait distributor meters bait in pre-set quantities.
- \* Safe - - Bait is underground, out of reach of animals and wildlife.
- \* Economical - - Bait costs are a few cents per acre.
- \* One pound of bait treats one acre.
- \* Replaceable hardened steel torpedo point.
- \* Bait hopper has 40 lb. capacity.

The Elston Gopher Getter builds and baits artificial gopher runways in one fast operation. Users acclaim the effectiveness of the kill.....The sturdy design and construction of the machine.....And the easy, low cost method to get rid of this rodent.

### 3-POINT HITCH GOPHER GETTER

Order No.	Description	Price
GA-400-18.....	Equipped with 18" coulter ass'y, single 9.50 x 18 pneumatic wheel, chain drive seeder, pre-set plate, tempered steel replaceable point, reinforced steel construction, width 32", length 38", fits all 3 point hydraulic equipped tractors. Wt. 372 lbs. ....	\$2159.00
GA-400-22.....	Same as above, but with 22" coulter ass'y. Wt. 382 lbs. ....	2258.80
GA-700.....	Extreme Duty Gopher Getter, Features: Larger H-D Frame, Cat. 1 & 2 Hitch, Spring Loaded Coulter, 15" Packer Wheel, Large Divided Bait Box (2 bait mixers), Easy Adjust Depth Control, Wt. 500 lbs. ....	3339.00

### TRAIL TYPE GOPHER GETTER

GA-500-18.....	Equipped with 18" coulter ass'y, 6 x 12 pneumatic tires, single 9.50 x 18 pneumatic wheel, high speed bearings, chain drive seeder, pre-set seeder plate, tempered steel replaceable point, shear pin, width 48", length 8'. HYDRAULIC CYLINDER AND HOSE NOT INCLUDED. Wt. 465 lbs. ....	3292.35
GA-500-22.....	Same as above, but with 22" coulter ass'y. Wt. 475 lbs. ....	3325.80

DEALER SCHEDULE.....102

ABOVE SUBJECT TO ADVANCE FREIGHT

## KAPUT-D Pocket Gopher Poison Bait

**NOTE:**

Licenses & permits required in some states governing sale of bait.

Please check with U.S. Dept. of Agriculture-Environmental Protection Agency or your State Dept. of Agriculture



Bait Type - Red Grain  
50# bags are Milo based  
5# pails are Wheat based  
Bait Active - Diphacinone

No.	Price
KD-09131-GM* ... KAPUT Gopher Bait, 50# Bag .....	\$184.80
KD-091105 ..... KAPUT Gopher Bait, 5# Pail .....	38.25

*\*Central requires a copy of your Pesticide Applicators License for sales of 50# bags of gopher bait.*

Dealer Schedule.....152

# Call Toll-Free 1-800-444-8666

## PARTS LIST FOR GA-400 & GA-500 GOPHER GETTER

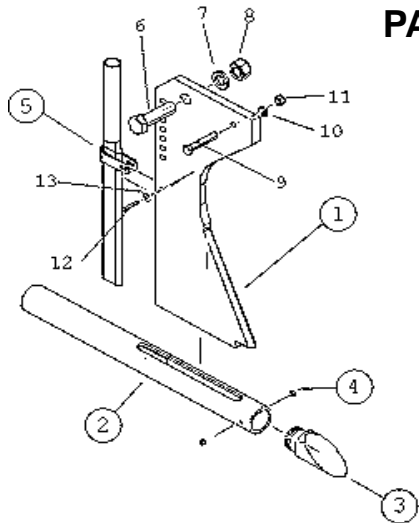

### KNIFE ASSEMBLY

Ref. No.	Part No.	Qty.	Description	Price
1	G1-103	1	Knife	\$335.75
2	G1-104	1	Torpedo Tube	113.90
3	G1-105	1	Torpedo Point	39.30
4	G1-143	2	3/8" Set Screw	.59
5	G1-193	1	Seeder Tube	17.65
12-15	G1-100	1	Knife Assembly Complete	479.05
6	G1-146	1	1" x 3-1/2" Cap Screw	4.30
7	G1-147	1	1" Lock Washer	.98
8	G1-148	1	1" Hex Nut	1.97
9	G1-000	1	1/2" x 3-1/2" Shear Bolt	1.29

### COULTER ASSEMBLY

Ref. No.	Part No.	Qty.	Description	Price
1	G2-326	1	Coulter Shank	\$45.15
2	G2-370-18	1	Coulter Blade - 18"	131.55
2	G2-370-20	1	Coulter Blade - 20"	166.90
2	G2-370-22	1	Coulter Blade - 22"	229.70
	G2-375	1	Coulter Clamp & Screw	12.60
4	G2-380-18	1	Coulter Sides f/18" Blade	78.55
	G2-380-22	1	Coulter Sides f/22" Blade	106.10
2-5,				
9-14	G2-100-18	1	Coulter Assembly, 18"	375.00
	G2-100-22	1	Coulter Assembly, 22"	481.00
12	G2-371	1	7/16"x4-1/2" Cap Screw Lockwasher & Nut	1.62

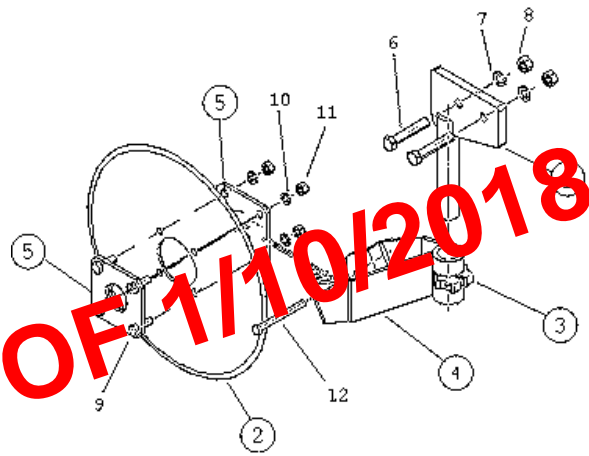

### COULTER BLADE HUB ASSEMBLY

Ref. No.	Part No.	Qty.	Description	Price
1	G2-381	1	Blade Flange with Hub	\$89.50
2	G2-382	1	Blade Flange	23.55
3	G2-383	1	Inner Bearing	19.63
4	G2-384	2	Bearing Cap	15.70

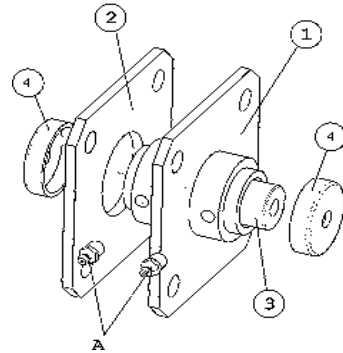

### PACKER WHEEL ASSEMBLY

Ref. No.	Part No.	Qty.	Description	Price
1	G3-292	1	Packer Wheel Bracket	\$104.05
2	G3-283	1	36 Tooth Sprocket	41.25
3	G3-324	2	Axle Bushing	3.95
5	G3-125	2	Packer Wheel Tire ONLY	43.19
6	G3-177	1	Axle for Packer Wheel	29.45
7	G3-321	1	Chain (Not Shown)	29.45
3,4,5	G3-120	1	Packer Wheels w/Tires	216.00
3,4	G3-121	1	Packer Wheels LESS Tires	178.70

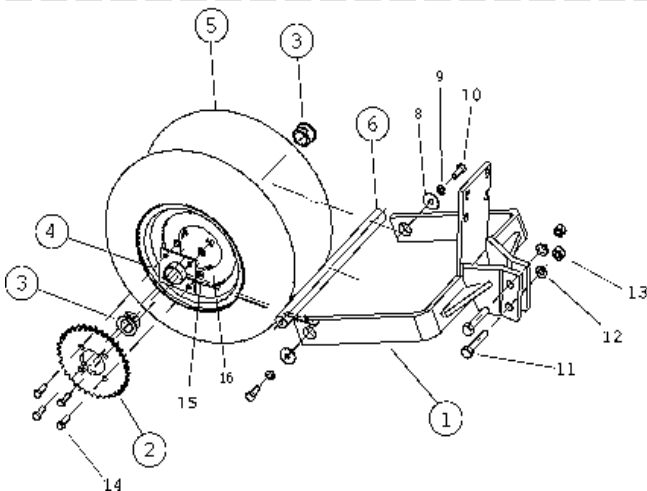

DEALER SCHEDULE THIS PAGE.....102

PARTS BREAKDOWNS CONTINUED ON NEXT PAGE

(Continued From Preceding Page)

**PARTS LIST FOR  
GA-400 & GA-500 GOPHER GETTER**

**Old Metal Seeder Box**

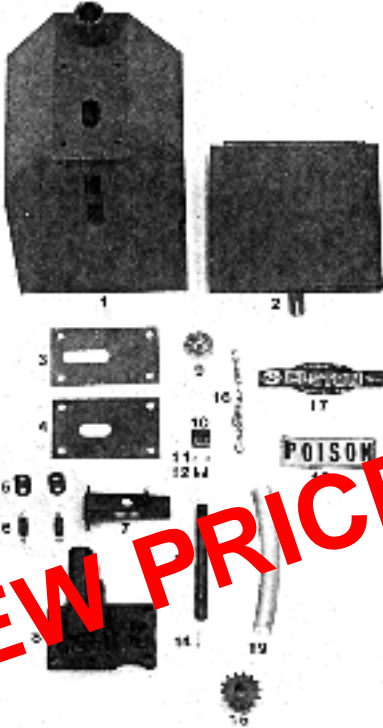

**PARTS LIST FOR  
GA-400 & GA-500 GOPHER GETTER**

**New Poly Seeder Box**

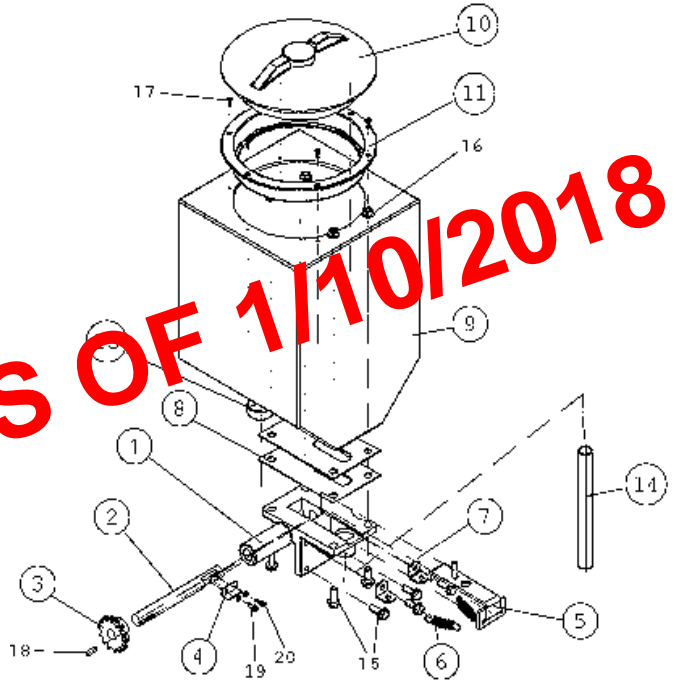

**NEW PRICES AS OF 1/10/2018**

**SEEDER ASSEMBLY - Metal Box**

Ref. No.	Part No.	Qty.	Description	Price
1	G4-230	1	Seeder Box Only	\$ N.A.
2	G4-231	1	Seeder Box Cover, Metal	20.93
3	G4-286	1	Poison Guide Plate	5.90
5	G4-278	2	Spring Holder Clips	2.41
6	G4-215	2	Springs	3.95
7	G4-208	1	Seeder Slide - 5/8" Hole	21.60
	G4-208A	1	Seeder Slide - 7/8" Hole	21.60
8	G4-200	1	Seeder Casting	109.95
9	G4-221	1	Drain Cap, Metal	8.33
10	G4-269	1	Tripper	5.90
11	G4-164	2	10-24 Internal Lockwasher	.15
12	G4-206	2	10-24 x 1/2" Allen Screws	.43
13	G4-201	1	Seeder Axle	35.35
14	G4-225	1	Key	.83
15	G4-203	1	Drive Gear	29.45
16	G4-232	1	Snap Hook w/Chain	5.20
17	G4-133	1	Elston Decal	1.27
18	G4-134	1	Poison Decal	.99
19	G4-122	1	Plastic Hose	5.35

**SEEDER ASSEMBLY - Poly Box**

Ref. No.	Part No.	Qty.	Description	Price
1	G4-200	1	Seeder Casting	\$109.95
2	G4-201	1	Seeder Axle	35.35
3	G4-203	1	Drive Gear	29.45
4	G4-269	1	Tripper	5.90
5	G4-208	1	Seeder Slide - 5/8" Hole	21.60
	G4-208A	1	Seeder Slide - 7/8" Hole	21.60
6	G4-215	2	Seeder Slide Spring	3.95
7	G4-278	1	Spring Holder Clip	2.41
8	G4-286	1	Poison Guide Plate	5.90
9	G4-230P	1	Seeder Box - Poly	210.00
10	G4-234P	1	Seeder Box Lid - Poly	N.A.
*	G4-233P	2	Lid Retaining Strap	3.95
10-12	G4-231P	1	Seeder Box Lid Assembly	49.10
13	G4-221P	1	Drain Cap	5.90
14	G4-122	1	Plastic Hose	5.35
9-13, 17	G4-235P	1	Seeder Box Assembly	265.00
1-20	G4-100P	1	Seeder Assembly	433.90

\*Not Shown

DEALER SCHEDULE THIS PAGE.....102

**Call Toll-Free 1-800-444-8666**

All Prices Are Subject To Change Without Notice

**PARTS LIST FOR  
GA-600 GOPHER GETTER JR.**

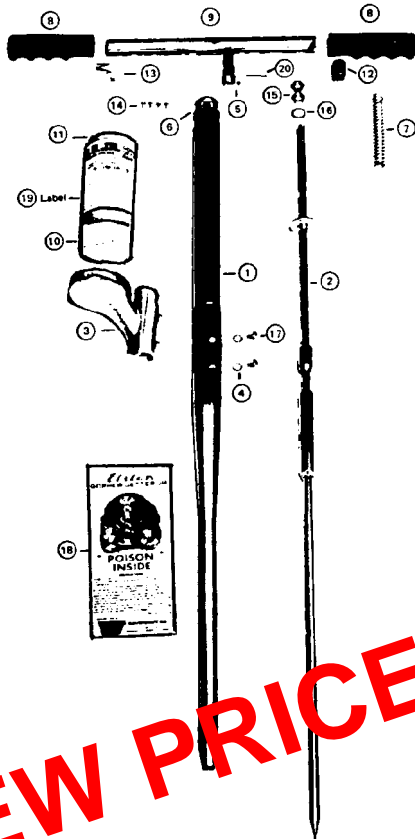

**GA-600  
GOPHER  
GETTER JR.**

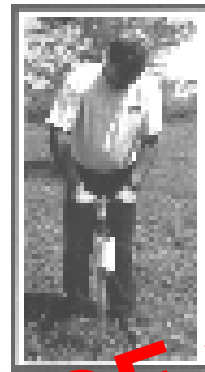

**NEW PRICES AS OF 1/10/2018**

Comes with empty bait jar. Bait NOT included.

An inexpensive cartridge loaded unit which dispenses poison bait automatically underground in pocket gophers natural runway, out of reach of harmless birds and pets.

**Child-Resistant Jar.**

STEP 1 - To poison pocket gophers, the natural runway must be located by probing about 12" to 18" from the mound on the side of the horseshoe-shaped depression.

STEP 2 - When runway is found, press red button on top of the handle letting the inside valve shaft telescope. Pull unit out of the ground, holding down the red button. The bait automatically drops into the gopher runway.

Ref. No.	Part No.	Qty.	Description	Price
1	G-601	1	Outside Casing	\$88.35
2	G-602	1	Rod Assembly	43.20
3	G-603	1	Casting	68.75
4	G-604	2	Washers	N.A.
5	G-605	1	Tripper	N.A.
6	G-606	1	Tripper Head	26.30
7	G-607	1	Spring	1.00
8	G-608	2	Handle Grip	N.A.
9	G-609	1	Handle	20.25
10	G-610	1	Cover Bait	N.A.
11	G-611	1	Bait Jar, 2" Threads	4.07
	G-611-2-5/8	1	Bait Jar, 2-5/8" Threads	4.07
12	G-614	1	1" Spacer	1.55
13	G-616	1	Handle Spring	N.A.
14	G-617	4	832 1/4" Screws	N.A.
15	G-619	1	7/16" Nut	N.A.
16	G-620	1	7/16" Washer	N.A.
17	G-621	2	1/4" Screws	N.A.
18	G-622	1	Casing Poison Label	N.A.
19	G-623	1	Jar Poison Label	N.A.
20	G-624	1	Rivet	N.A.
N.A.	G-625	1	Bottle Clamp	15.25

Dealer Schedule.....102

No.	Description	Price
GA-600	Gopher Getter Jr.	\$253.85

DEALER SCHEDULE.....152

**We Ship  
Over 95%  
Of Our Orders  
The Same Day!**

# 4 BOLT WHEEL HUBS

4 BOLT, 5" BOLT CIRCLE, 3.62 PILOT

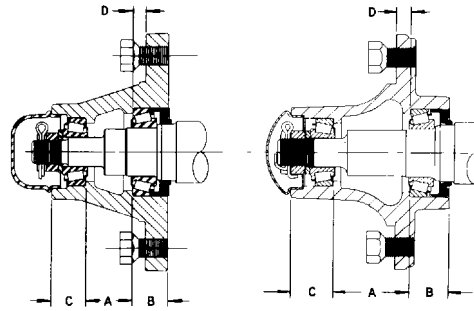
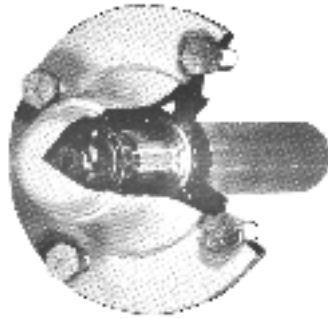

504-0669

504-0633

Hub No.	Inner Cup	Outer Cup	Inner Cone	Outer Cone	Wheel Bolt	Wheel Nut	Hub Cap	Grease Seal	Dimensions				Lbs. Cap.	Spindle No.	Ass'y No.
			Bore	Bore					A	B	C	D			
504-0669	LM67010	LM11910	LM67048 1.25	LM11949 .75	54000820		56102211	513-0558	1.16	.94	.88	.38	1250*	1	G-669
504-0633	LM67010	LM11910	LM67048 1.25	LM11949 .75	54000820		56102211	513-0558	2.00	1.00	1.12	.38	1500*	5	G-633

\*Wheel Hub Capacities as stated are in relation to static gross capacity on a free rolling wheel at normal tractor speeds not exceeding 20 MPH. Stated hub capacities are based on 20,000 mile, B-120 bearing life and 14,000 PSI maximum fiber stress on the spindle in the bearing and seal area.

# 5 BOLT WHEEL HUBS

5 BOLT, 4.5" BOLT CIRCLE, 2.62 PILOT

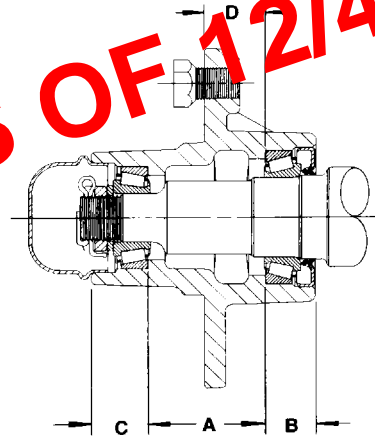

505-3181 50503181

Hub No.	Inner Cup	Outer Cup	Inner Cone	Outer Cone	Wheel Bolt	Wheel Nut	Hub Cap	Grease Seal	Dimensions				Lbs. Cap.	Spindle No.	Ass'y No.
			Bore	Bore					A	B	C	D			
505-3181	L68111	LM12711	L68149 1.38	LM12749 .87	54000820		56102211	513-0608	1.88	.90	.97	.92	1750*	2	G-3181
50503181*	L68111	LM12711	L68149 1.38	LM12749 .87	54000820		56102211	513-0608	1.88	.90	.97	.92	1750*	2A	G-3181A

\*Wheel Hub Capacities as stated are in relation to static gross capacity on a free rolling wheel at normal tractor speeds not exceeding 20 MPH. Stated hub capacities are based on 20,000 mile, B-120 bearing life and 14,000 PSI maximum fiber stress on the spindle in the bearing and seal area.

Hubs are complete with all components except spindle.

<b>Hub No.</b>	Each	<b>Inner Cone</b>	Each	<b>Grease Seal</b>	Each
504-0626 .....	\$97.50	4T-LM67048 .....	\$6.75	513-0558 .....	\$6.66
504-0633 .....	90.12	4T-L68149 .....	7.75	513-0608 .....	9.76
504-0669 .....	99.32	<b>Outer Cone</b>		<b>Spindle Series</b>	
505-3181 .....	89.82	4T-LM11949 .....	5.60	521-0163 ..... 1 .....	37.81
50503181 .....	89.82	4T-LM12749 .....	16.68	522-0150 ..... 2 .....	40.87
<b>Inner Cup</b>		<b>Wheel Bolt</b>		522-0175 ..... 2A .....	54.26
4T-LM67010 .....	3.45	54000820 .....	1.26	525-0163 ..... 5 .....	40.68
4T-L68111 .....	3.50	<b>Hub Cap</b>		Dealer Schedule.....	152
<b>Outer Cup</b>		56102211 .....	3.38		
4T-LM11910 .....	3.00				
4T-LM12711 .....	6.40				

ALL PRICES SUBJECT TO CHANGE WITHOUT NOTICE.

NEW PRICES AS OF 12/4/2018



**5 BOLT, 5.5" BOLT CIRCLE, 4.00 PILOT**

**5 BOLT WHEEL HUBS**

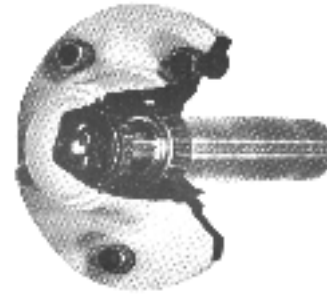
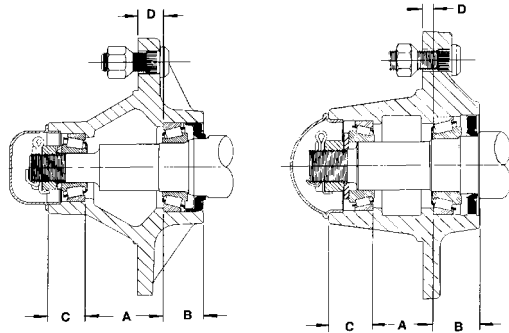

50510736

50510719

Hub No.	Inner Cup	Outer Cup	Inner		Outer		Wheel Bolt	Wheel Nut	Hub Cap	Grease Seal	Dimensions				Lbs. Cap.	Spindle No.	Ass'y No.
			Cone	Bore	Cone	Bore					A	B	C	D			
50510736	LM67010	LM11910	LM67048	1.25	LM11949	.75	540-0820	550-0820	561-2209	513-0558	2.00	1.00	.94	.62	1650*	5	G-736
50510719	LM48510	LM67010	LM48548	1.38	LM67048	1.25	54100820	55000820	560-2008	513-0574	1.56	1.25	1.06	.22	2760*	3	G-719

\*Wheel Hub Capacities as stated are in relation to static gross capacity on a free rolling wheel at normal tractor speeds not exceeding 20 MPH. Stated hub capacities are based on 20,000 mile, B-120 bearing life and 14,000 PSI maximum fiber stress on the spindle in the bearing and seal area.

**6 BOLT, 5.5" BOLT CIRCLE, 3.37 PILOT**

**6 BOLT WHEEL HUBS**

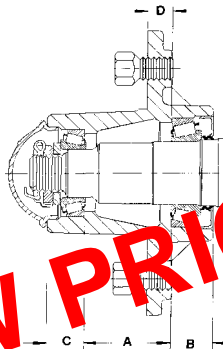

506-3192  
50603192

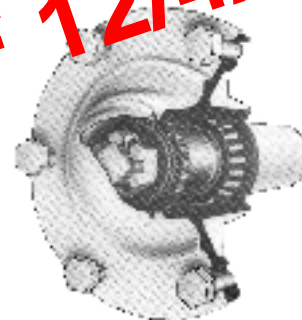

NEW PRICES AS OF 12/4/2018

Hub No.	Inner Cup	Outer Cup	Inner		Outer		Wheel Bolt	Wheel Nut	Hub Cap	Grease Seal	Dimensions				Lbs. Cap.	Spindle No.	Ass'y No.
			Cone	Bore	Cone	Bore					A	B	C	D			
506-3192*	LM501310	LM67010	LM501349	1.63	LM67048	1.25	540-0820		560-2008	513-0616	2.16	1.00	.97	.62	2600*	6	G-3192
50603192*	LM501310	LM67010	LM501349	1.63	LM67048	1.25	540-0820		560-2008	513-0616	2.16	1.00	.97	.62	2600*	6A	G-3192A

\*Wheel Hub Capacities as stated are in relation to static gross capacity on a free rolling wheel at normal tractor speeds not exceeding 20 MPH. Stated hub capacities are based on 20,000 mile, B-120 bearing life and 14,000 PSI maximum fiber stress on the spindle in the bearing and seal area.

**Hubs are complete with all components except spindle.**

<b>Hub No.</b>	Each	<b>Inner Cone</b>	Each	<b>Hub Cap</b>	Each
50510719 .....	\$103.66	4T-LM48548 .....	\$8.10	560-2008 .....	\$5.84
50510736 .....	94.84	4T-LM501349 .....	11.10	561-2209 .....	4.45
506-3192 .....	135.94	4T-LM67048 .....	6.75	<b>Grease Seal</b>	
50603192 .....	135.94	<b>Outer Cone</b>		513-0558 .....	6.66
<b>Inner Cup</b>		4T-LM11949 .....	5.60	513-0574 .....	8.30
4T-LM48510 .....	3.85	4T-LM67048 .....	6.75	513-0616 .....	9.78
4T-LM501310 .....	5.28	<b>Wheel Bolt</b>		<b>Spindle Series</b>	
4T-LM67010 .....	3.45	540-0820 .....	.98	523-0175 ..... 3 .....	47.66
<b>Outer Cup</b>		541-0820 .....	5.62	525-0163 ..... 5 .....	40.68
4T-LM11910 .....	3.00	54100820 .....	5.62	526-0175 ..... 6 .....	54.48
4T-LM67010 .....	3.45	<b>Wheel Nut</b>		526-0200 ..... 6A .....	71.20
		550-0820 .....	.86		
		55000820 .....	1.26		

Dealer Schedule.....152

# 6 BOLT WHEEL HUBS

6 BOLT, 6" BOLT CIRCLE, 4.62 PILOT

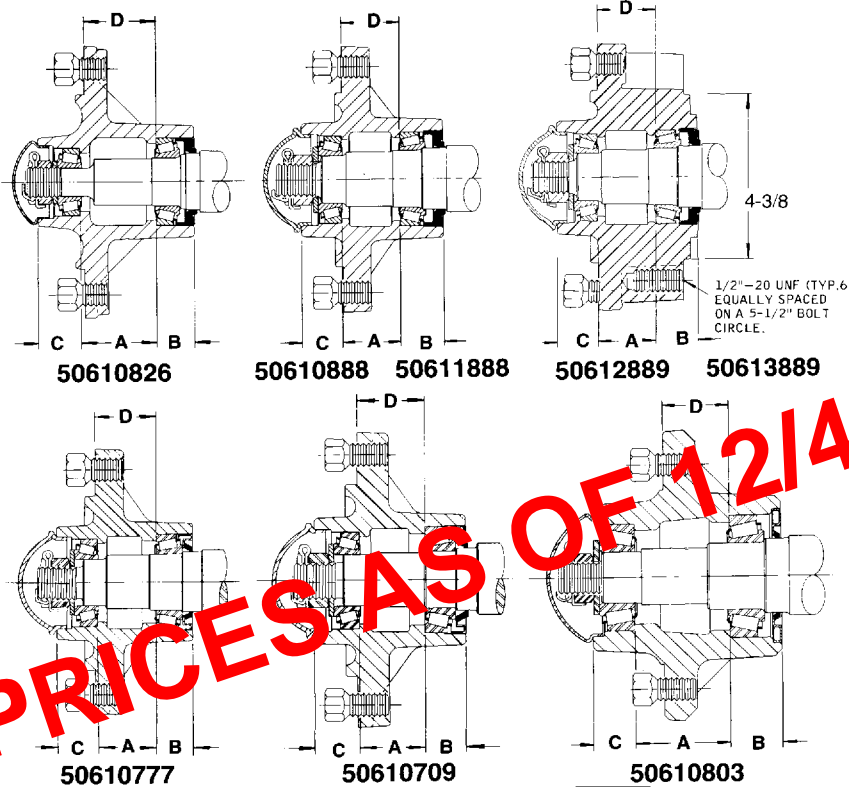

NEW PRICES AS OF 12/4/2018

Hub No.	Inner Cup	Outer Cup	Inner Cone	Inner Bore	Outer Cone	Outer Bore	Wheel Bolt	Wheel Nut	Hub Cap	Grease Seal	Dimensions				Lbs. Cap.	Spindle No.	Ass'y No.
											A	B	C	D			
50610826	LM67010	LM11910	LM67048	1.25	LM11949	.75	54000820		56102211	513-0558	2.00	1.00	1.12	1.88	1650*	5	G-826
50610888*	JL69310	LM67010	JL69349	1.50	LM67048	1.25	540-0820		560-2008	513-0582	1.52	1.12	1.06	1.52	3560*	4	G-888
50611888*	JL69310	LM67010	JL69349	1.50	LM67048	1.25	540-0820		560-2008	513-0582	1.52	1.12	1.06	1.52	3560*	4A	G-888A
50612889	JL69310	LM67010	JL69349	1.50	LM67048	1.25	540-0820		560-2008	513-0582	1.52	1.12	1.06	1.52	3560*	4	G-889
50613889	JL69310	LM67010	JL69349	1.50	LM67048	1.25	540-0820		560-2008	513-0582	1.52	1.12	1.06	1.52	3560*	4A	G-889A
50610777	LM29710	LM67010	LM29749	1.50	LM67048	1.25	540-0820		560-2008	513-0582	1.56	1.00	1.06	1.50	3560*	10	G-777
50610709	LM48510	LM67010	LM48548	1.38	LM67048	1.25	540-0820		560-2008	513-0574	1.56	1.00	1.06	1.59	2760*	3	G-709A
50610803	25520	25821	25590	1.80	25877	1.38	54000918		562-2207	513-0590	2.50	1.38	1.13	1.75	4910*	7	G-803

\*Wheel Hub Capacities as stated are in relation to static gross capacity on a free rolling wheel at normal tractor speeds not exceeding 20 MPH. Stated hub capacities are based on 20,000 mile, B-120 bearing life and 14,000 PSI maximum fiber stress on the spindle in the bearing and seal area.

Hubs are complete with all components except spindle.

Hub No.	Each	Inner Cone	Each	Grease Seal	Each	
50610709	\$99.30	4T-25590	\$13.43	513-0558	\$6.66	
50610777	106.92	4T-LM29749	10.31	513-0574	8.30	
50610803	159.50	4T-LM48548	8.10	513-0582	6.40	
50610826	99.06	4T-LM67048	6.75	513-0590	9.46	
50610888	99.30	4T-JL69349	7.85	<b>Spindle Series</b>		
50611888	99.30	<b>Outer Cone</b>		523-0175	3	47.66
50612889	182.56	4T-25877	27.00	524-0175	4	48.98
50613889	182.56	4T-LM11949	5.60	524-0200	4A	63.12
<b>Inner Cup</b>		4T-LM67048	6.75	525-0163	5	40.68
4T-25520	7.28	<b>Wheel Bolt</b>		527-0212	7	77.00
4T-LM29710	6.75	540-0820	.98	530-0175	10	45.28
4T-LM48510	3.85	54000820	1.26	Dealer Schedule.....152		
4T-LM67010	3.45	54000918	1.84			
4T-JL69310	4.00	<b>Hub Cap</b>				
<b>Outer Cup</b>		560-2008	5.84			
4T-25821	11.40	56102211	3.38			
4T-LM11910	3.00	562-2207	7.94			
4T-LM67010	3.45					

**ALL PRICES ARE SUBJECT TO CHANGE WITHOUT NOTICE!**

# 8 BOLT WHEEL HUBS



## 8 BOLT, 8" BOLT CIRCLE, 6.00 PILOT

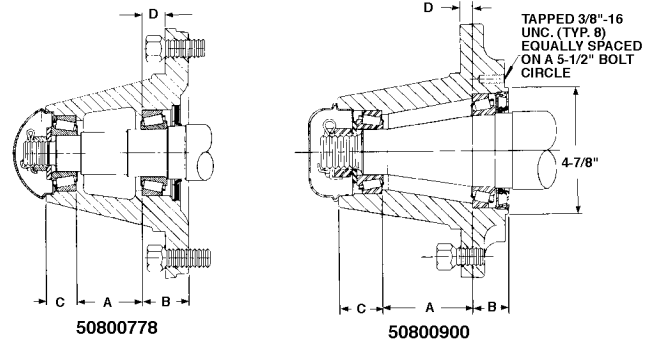

Hub No.	Inner		Outer		Wheel Bolt		Wheel Nut	Hub Cap	Grease Seal	Dimensions				Lbs. Cap.	Spindle No.	Ass'y No.
	Cup	Cone	Cup	Bore	Cone	Bore				A	B	C	D			
50800778	25520	25590	25821	1.8	25877	1.38	54000918	562-2207	513-0590	2.50	1.75	1.12	.88	4910*	7	G-778
50800900*	LM613410	LM613449	25521	2.75	25580	1.75	54000918	561-2618	513-0749	3.44	1.44	1.63	.38	9000**	8	G-900

\*Wheel Hub Capacities as stated are in relation to static gross capacity on a free rolling wheel at normal tractor speeds not exceeding 20 MPH. Stated hub capacities are based on 20,000 mile, B-120 bearing life and 14,000 PSI maximum fiber stress on the spindle in the bearing and seal area.

# 10 BOLT WHEEL HUBS



## 10 BOLT, 11.25" BOLT CIRCLE, 8.62 PILOT AND 8.66 PILOT

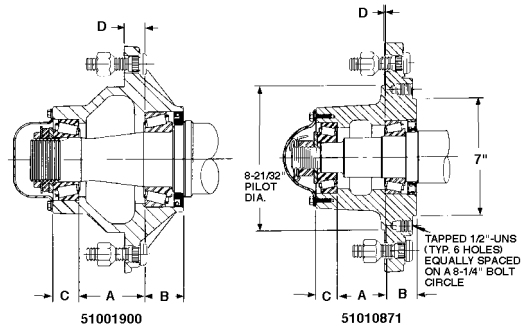

Hub No.	Inner		Outer		Wheel Bolt		Wheel Nut	Hub Cap	Grease Seal	Dimensions				Lbs. Cap.	Spindle No.	Ass'y No.
	Cup	Cone	Cup	Bore	Cone	Bore				A	B	C	D			
51001900	653	663	HM212011	3.25	HM212049	2.63	54101216	563-3600	513-0541	3.88	2.32	1.35	1.16	19000*	9	G-1900
51010871*	39520	39585	453A	2.50	460	1.75	54101216	564-2700	513-0632	2.81	1.72	1.28	.06	13800**	11	G-871

\*Wheel Hub Capacities as stated are in relation to static gross capacity on a free rolling wheel at normal tractor speeds not exceeding 20 MPH. Stated hub capacities are based on 20,000 mile, B-120 bearing life and 14,000 PSI maximum fiber stress on the spindle in the bearing and seal area.

Hubs are complete with all components except spindle.

Hub No.	Each	Inner Cone	Each	Hub Cap	Each
50800778	\$269.20	4T-663	\$149.97	561-2618	\$11.30
50800900	433.66	4T-25590	13.43	562-2207	7.94
51001900	668.68	4T-39585	92.66	563-3600	54.48
51010871	869.24	4T-LM613449	109.95	564-2700	32.98
<b>Inner Cup</b>		<b>Outer Cone</b>		<b>Grease Seal</b>	
4T-653	38.56	4T-460	139.97	513-0541	37.84
4T-25520	7.28	4T-25580	14.38	513-0590	9.46
4T-39520	32.14	4T-25877	27.00	513-0632	24.95
4T-LM613410	46.12	4T-HM212049	125.10	513-0749	19.90
<b>Outer Cup</b>		<b>Wheel Bolt</b>		<b>Spindle Series</b>	
4T-453A	34.05	54000918	1.84	527-0212	77.00
4T-25821	11.40	54101216	12.36	528-0300	160.44
4T-HM212011	30.22	<b>Wheel Nut</b>		529-0450	336.70
		55001216	6.10	531-0312	186.44

## STANDARD SPINDLE ASSEMBLIES

Spindle	Series	Each
521-0163	1	\$37.10
522-0150	2	40.87
522-0175	2A	54.26
523-0175	3	47.66
524-0175	4	48.98
524-0200	4A	63.12
525-0163	5	40.68
526-0175	6	54.48
526-0200	6A	71.20
527-0212	7	77.00
528-0300	8	160.44
529-0450	9	336.07
530-0175	10	45.28
531-0312	11	186.44

Dealer Schedule.....152

### STYLE A

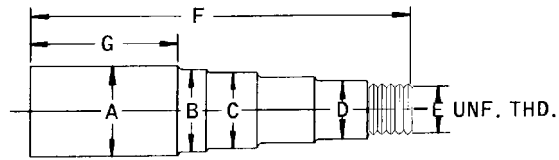

### STYLE B

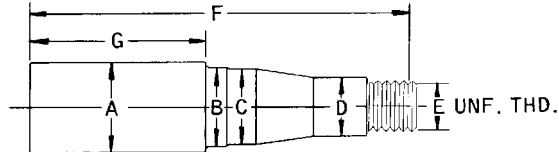

NO.	STYLE	A	B	C	D	E	F	G	G & G * NUMBER
1	A	1.63 O.D.	1.50	1.2495/1.2480	.7495/.7480	5/8"-18	9.00	5.34	521-0163
2	A	1.50 O.D.	1.44	1.3767/1.3747	.8650/.8630	3/4"-16	11.00	6.7	522-0150
2A	A	1.75 O.D.	1.44	1.3767/1.3747	.8650/.8630	3/4"-16	11.7	7.0	522-0175
3	A	1.75 O.D.	1.50	1.3745/1.3735	1.2495/1.2480	7/8"-14	11.50	7.12	523-0175
4	A	1.75 O.D.	1.63	1.4951/1.4941	1.2495/1.2485	7/8"-14	12.50	8.07	524-0175
4A	A	2.00 O.D.	1.63	1.4951/1.4941	1.2495/1.2485	7/8"-14	14.00	9.57	524-0200
5	A	1.63 O.D.	1.50	1.2495/1.2480	.7495/.7480	3/4"-16	10.38	5.79	525-0163
6	A	1.75 O.D.	1.69	1.6245/1.6235	1.2495/1.2485	1"-14	14.00	9.30	526-0175
6A	A	2.00 O.D.	1.69	1.6245/1.6235	1.2495/1.2485	1"-14	14.00	9.30	526-0200
7	A	2.12 O.D.	2.00	1.7745/1.7735	1.3745/1.3735	7/8"-14	15.44	9.33	527-0212
8	B	3.00 O.D.	2.8	2.7495/2.7480	1.7495/1.7480	1-1/4"-12	15.44	8.12	528-0300
9	B	4.50 O.D.	3.00	3.2495/3.2480	2.6245/2.6230	2-5/8"-16	15.38	6.50	529-0450
10	A	1.75 O.D.	1.63	1.4995/1.4985	1.2495/1.2485	7/8"-14	12.50	8.03	530-0175
11	A	1.12 O.D.	3.00	2.4995/2.4980	1.7495/1.7480	1-1/4"-12	17.38	10.00	531-0312

\* THE ASSEMBLY NUMBER INCLUDES SPINDLE AND ALL SPINDLE HARDWARE. (WASHER, NUT, AND COTTER PIN)

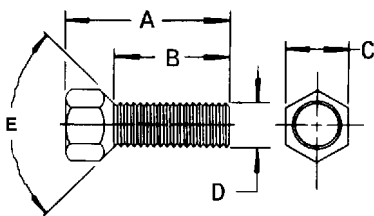

### WHEEL BOLTS

Grade 5

Order No.	A	B	C	D	E	Each
540-0820	1.50"	1.00"	0.75"	1/2"-20 UNF	90°	\$.98
54000820	1.25"	0.75"	0.75"	1/2"-20 UNF	90°	1.26
54000918	1.75"	1.13"	0.88"	9/16"-18 UNF	90°	1.84

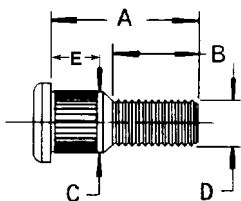

Order No.	A	B	C	D	E	Each
541-0820	1.50"	1.15"	0.62"	1/2"-20 UNF	.35"	\$5.62
54100820	1.63"	1.26"	0.62"	1/2"-20 UNF	.35"	5.62
54101216	2.56"	1.16"	0.98"	3/4"-16 UNF	.50"	12.36

Dealer Schedule.....152

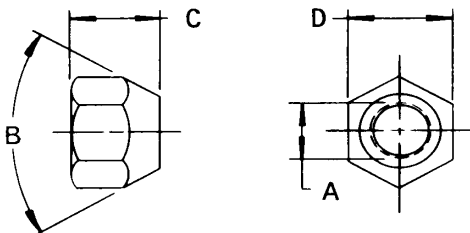

### WHEEL BOLT NUTS

Grade 5

Nut No.	A	B	C	D	Each
550-0820	1/2"-20	90°	21/32"	13/16"	\$.86
55000820	1/2"-20	90°	9/16"	3/4"	1.26
55001216	3/4"-16	100°	7/8"	1-1/2"	6.01

Dealer Schedule.....152

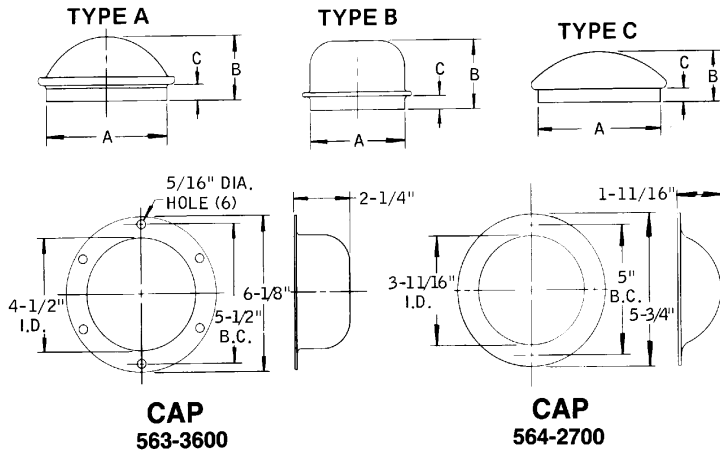

**HUB CAPS**

Cap No.	Type	A	B	C	Each
560-2008	A	2.448	1-1/4"	1/4"	\$5.84
561-2209	B	1.943	1-3/8"	9/32"	4.45
561-2618	B	3.355	1-5/8"	9/16"	11.00
56102211	B	1.958	1-3/8"	11/32"	3.38
562-2207	C	3.157	1-3/8"	7/32"	7.94
563-3600	See Drawing				54.48
564-2700	See Drawing				32.98

Dealer Schedule.....152

**WHEEL BOLTS & STUDS**

Grade 5

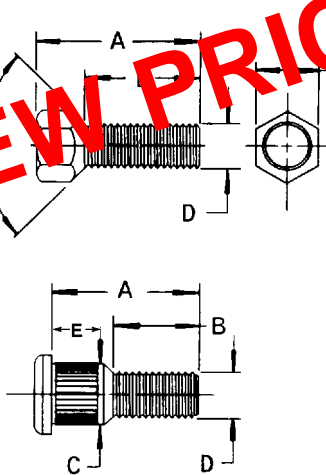

Order No.	A	B	C	D	E	Each
WB12112	1-1/2"	1"	3/4"	1/2"-20 UNF	90°	\$1.15
WB1211460	1-5/8"	7/8"	13/16"	1/2"-20 UNF	60°	2.44
WB12214	2-1/4"	1-3/4"	3/4"	1/2"-20 UNF	90°	3.33
WB58214	2-3/8"	1-3/4"	15/16"	5/8"-18 UNF	90°	3.46
WB58312	3-5/8"	3"	15/16"	5/8"-18 UNF	90°	4.10
WB71611860	1-1/8"	3/4"	5/8"	7/16"-20 UNF	60°	2.70
WB916158	1-3/4"	1-1/8"	7/8"	9/16"-18 UNF	90°	2.18
WB916212	2-1/2"	1-7/8"	7/8"	9/16"-18 UNF	90°	3.59
WB916218	2-1/8"	1-1/2"	7/8"	9/16"-18 UNF	90°	2.44

Order No.	A	B	C	D	E	Each
WS12158	2"	1-1/2"	5/8"	1/2"-20 UNF	3/8"	\$1.54
WS583	3"	2"	11/16"	5/8"-18 UNF	5/8"	5.00
WS58358	3-5/8"	2-3/4"	11/16"	5/8"-18 UNF	5/8"	4.25
WS916238	2-3/8"	1-3/8"	3/4"	9/16"-18 UNF	3/4"	2.82

WBA-2 ..... Wheel Bolt, Stud and Nut Assortment (120) Piece ..... \$338.00  
 WBA-3 ..... Wheel Bolt, Stud and Nut Assortment (180) Piece ..... 494.10

Dealer Schedule.....204

**WHEEL BOLT NUTS (Grade 5)**

Nut No.	A	B	C	D	Each
WN12	1/2"-20	90°	5/8"	13/16"	\$.90
WN1260	1/2"-20	60°	5/8"	13/16"	.90
WN58	5/8"	90°	11/16"	15/16"	2.18
WN58HD	5/8"	90°	11/16"	1-1/16"	3.33
WN916	9/16"	90°	11/16"	1"	2.18

Dealer Schedule.....204

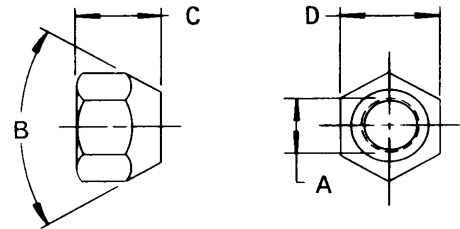

**WHEEL REINFORCING RINGS**

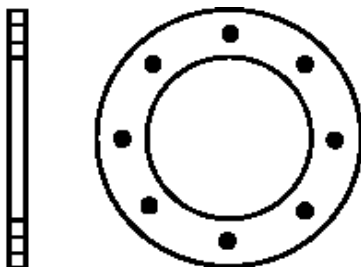

Order No.	O.D.	I.D.	Thick	Bolt C to C	Hole Size	Hole Type	Each
6-HRR	7-3/4"	4-3/4"	1/4"	6"	5/8"	Taper	\$44.35
8-HRR	10-1/4"	6"	5/16"	8"	11/16"	Taper	50.25
9-HRR	11-3/4"	7-3/4"	5/16"	9-1/2"	11/16"	Taper	53.35
10-HRR	15-1/2"	11"	5/16"	13-1/4"	15/16"	Straight	136.20

Dealer Schedule.....204

NEW PRICES AS OF 12/4/2018

# Midwest Bolster Hoist Cylinder & Cylinder Repair Parts

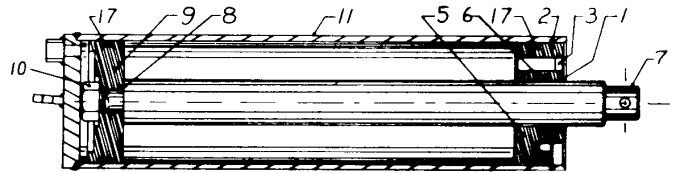
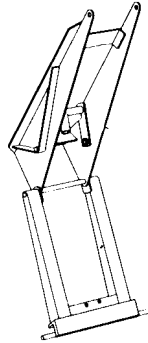

LP SERIES 6" CYLINDER

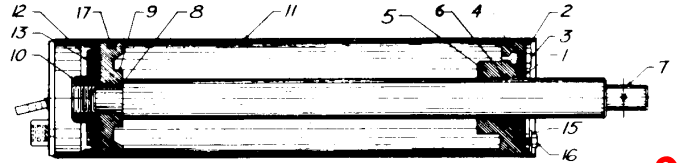

LP SERIES 5" CYLINDER

**NEW PRICES AS OF 9/1/2020**

No.	Description	Wt.	Price
LP-1000	Hydraulic Cylinder, 3000 PSI, (6" x 24") used with M-7-10 (10 ton capacity)	78	\$651.79

**"O" Ring & Seal Kits**

No.	Description	Price
X-50	Repair Kit For "O" Ring Type 5" Cylinder	16.64
X-50-C	Repair Kit For Cup Seal Type 5" Cylinder	70.30
X-60	Repair Kit For "O" Ring Type 6" Cylinder	45.18

**Parts Price List For LP-600 & LP-700 5" Cylinders and LP-1000 6" Cylinder**

No.	Ref.	Description	Wt.	Price
BR-208-1438	1	Wiper Seal for 5" cylinder (#3220007)		\$15.56
CS-2-415	1	Wiper Seal for 6" cylinder		5.56
RRT-5.260	2	Snap Ring for 5" cylinder (#1720100)		15.56
CS-2-416	2	Snap Ring for 6" cylinder		22.29
D-26	4	5" Gland Seal for 5" cylinder (#3220025)		2.22
D-25	6	1-3/4" Gland Seal for 5" cylinder (#3220023)		2.22
CS-2-413	6	Gland Seal for 6" cylinder		1.78
D-23	8	1-1/4" Seal for 5" cylinder (#3220021)		2.22
CS-2-410	8	1-1/4" Seal for 6" cylinder		1.60
CS-2-407	9	Piston for 6" cylinder	6	102.22
CS-570	12	Cup Seal for 5" cylinder (#3210059)		59.42
D-88	17	"O" Ring for 5" cylinder (#3220015)		4.44
CS-2-409	17	"O" Ring for 6" cylinder (2 required)		5.56
CS-2-412	17	Backup Washer for 6" cylinder		13.33

Dealer Schedule.....102

ALL PRICES SUBJECT TO CHANGE WITHOUT NOTICE.

## Midwest LIFT HARROW & BUSTER-BAR MASTER PARTS PRICE LIST

No.	Description	Price	No.	Description	Price	No.	Description	Price
LH-100	.. Casting	\$5.79	LH-106	.. U-Bolt-3/8"	\$1.19	LH-301	.. Casting-10B	\$3.02
LH-102	.. 3/8" Hex Lock Nut	.22	LH-107	.. U-Bolt-1/2"	2.36	LH-302	.. U-Bolt-7/16"	2.45
LH-104	.. FC-20 Spring	5.99	LH-114	.. Spring Tooth Frame-LH4	74.49	LH-5	..... Harrow Section 7'6"	260.00
LH-105	.. Casting Tooth Bar-10F	2.30	LH-3	..... Harrow Section 5'	145.00	LH-516	.. Bolt on BB Tooth	7.68

DEALER SCHEDULE THIS PAGE.....102 Midwest parts available while quantities last.

**ALL CAST IRON SEGMENTS FOR DURABILITY**

**USE WITH ANY HYDRAULIC CYLINDER**

**ACTS AS SPACER TO SHORTEN CYLINDER STROKE**

**PROVIDES 1/4" ADJUSTMENTS FROM 1" TO 5-1/2"**

For Stroke Reduction	Use Segment	For Stroke Reduction	Use Segment
1" .....	1"	3-1/2" .....	1", 1", 1-1/2"
1-1/4" .....	1-1/4"	3-3/4" .....	1", 1-1/4", 1-1/2"
1-1/2" .....	1-1/2"	4" .....	1", 1-1/4", 1-3/4"
1-3/4" .....	1-3/4"	4-1/4" .....	1", 1-1/2", 1-3/4"
2" .....	1", 1"	4-1/2" .....	1-1/4", 1-1/2", 1-3/4"
2-1/4" .....	1", 1-1/4"	4-3/4" .....	1", 1", 1-1/4", 1-1/2"
2-1/2" .....	1", 1-1/2"	5" .....	1", 1", 1-1/4", 1-3/4"
2-3/4" .....	1", 1-3/4"	5-1/4" .....	1", 1", 1-1/2", 1-3/4"
3" .....	1-1/4", 1-3/4"	5-1/2" .....	1", 1-1/4", 1-1/2", 1-3/4"
3-1/4" .....	1-1/2", 1-3/4"	6-1/2" .....	1", 1", 1-1/4", 1-1/2", 1-3/4"

**Hub City Stroke Control Segments**

**FITS SHAFT SIZES 1" THRU 1-3/4"**



**NEW PRICES AS OF 3/21/2021**



Order No.	Price
03-39-80001 .....	1" Segment ..... \$10.95
03-39-80002 .....	1-1/4" Segment ..... 10.95
03-39-80003 .....	1-1/2" Segment ..... 10.95
03-39-80004 .....	1-3/4" Segment ..... 10.95

Order No. 03-39-80000 ... Stroke Control Segment Set (Consists Of: (2) 1", (1) 1-1/4", (1) 1-1/2", (1) 1-3/4" Segments)..... Per Set **Price \$48.90**

Dealer Schedule.....152

**Central Cylinder Stop Sets**

*Will not crush under extreme pressure!*

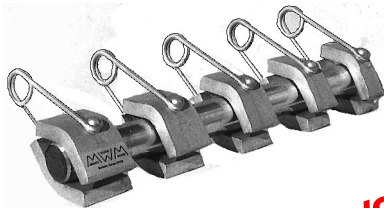

**FITS SHAFT SIZES 1-1/4" THRU 2"**

Offers positive control of cylinder travel. Simple to install and remove. Held in place by heavy spring. Fabricated of 1/2" steel.

**Set Consists Of 1 each: 3/4", 1", 1-1/4", 1-1/2", 1-3/4".**

No.	Description	Price
CCS-A5 .....	Set for 1-1/4" to 2" shafts .....	\$76.50
CCS-08 .....	1/2" Stroke Control Segment.....	16.50
CCS-12 .....	3/4" Stroke Control Segment.....	16.50
CCS-16 .....	1" Stroke Control Segment.....	16.50
CCS-20 .....	1-1/4" Stroke Control Segment ....	16.50
CCS-24 .....	1-1/2" Stroke Control Segment ....	16.50
CCS-28 .....	1-3/4" Stroke Control Segment ....	16.50

Dealer Schedule.....152

**WHOA-STOP with Wings**

**STROKE CONTROL SEGEMENTS**

**For Agricultural and Industrial Applications!**

**Sold In Sets Only!**

Flat Springs and "Wings" for easy installation and removal.



**NEW PRICES AS OF 4/21/2021**

The simple and reliable way to control the stroke on air or hydraulic cylinders. Segements are non-abrasive, won't score shafts or damage seals.

**#WS-9899 contains:**

7/8", 1", 1-1/4", 1-1/2" segments for 1-1/8" thru 1-1/2" shafts.

**#WS-9697 contains:**

1", 1-1/2", 2", 4-1/4" segments for 1-3/4" thru 2" shafts.

#WS-9697 for cylinders with 16" stroke or greater

Order No.	Description	Price
WS-9899 .....	Fits 1-1/8" thru 1-1/2" Shafts .....	\$37.63
WS-9697 .....	Fits 1-3/4" thru 2" Shafts .....	69.19

Dealer Schedule.....203

All Prices Are Subject To Change Without Notice

**To Order Call Toll-Free:**  
**1-800-444-8666**



# CHIEF Hydraulic Cylinders

DOUBLE ACTING TIE ROD TYPE

Order No.	Bore	Stroke*	Rod	Dimensions		Rated PSI	Port Size	Pin Dia.	Wt. Lbs.	List
			Dia.	Retracted	Extended					
214-303	2"	8" ASAE	1-1/8"	20-1/4"	28-1/4"	3000	SAE 8	1"	19	\$187.03
214-304	2"	10"	1-1/8"	20-1/4"	30-1/4"	3000	SAE 8	1"	19	195.01
214-305	2"	12"	1-1/8"	22-1/4"	34-1/4"	3000	SAE 8	1"	22	201.41
214-306	2"	14"	1-1/8"	24-1/4"	38-1/4"	3000	SAE 8	1"	22	209.41
214-307	2"	16"	1-1/8"	26-1/4"	42-1/4"	3000	SAE 8	1"	22	217.39
214-308	2"	18"	1-1/8"	28-1/4"	46-1/4"	3000	SAE 8	1"	25	225.38
214-309	2"	20"	1-1/8"	30-1/4"	50-1/4"	3000	SAE 8	1"	27	265.90
214-311	2"	24"	1-1/8"	34-1/4"	58-1/4"	3000	SAE 8	1"	30	249.37
214-323	2-1/2"	8" ASAE	1-1/8"	20-1/4"	28-1/4"	3000	SAE 8	1"	21	221.33
214-324	2-1/2"	10"	1-1/8"	20-1/4"	30-1/4"	3000	SAE 8	1"	22	201.41
214-325	2-1/2"	12"	1-1/8"	22-1/4"	34-1/4"	3000	SAE 8	1"	24	209.41
214-326	2-1/2"	14"	1-1/4"	24-1/4"	38-1/4"	3000	SAE 8	1"	27	217.39
214-327	2-1/2"	16"	1-1/4"	26-1/4"	42-1/4"	3000	SAE 8	1"	29	225.38
214-328	2-1/2"	18"	1-1/4"	28-1/4"	46-1/4"	3000	SAE 8	1"	30	233.38
214-329	2-1/2"	20"	1-1/4"	30-1/4"	50-1/4"	3000	SAE 8	1"	30	275.42
214-331	2-1/2"	24"	1-1/4"	34-1/4"	58-1/4"	3000	SAE 8	1"	33	257.36
214-348	3"	8" ASAE	1-1/4"	20-1/4"	28-1/4"	3000	SAE 8	1"	28	209.41
214-349	3"	10"	1-1/4"	20-1/4"	30-1/4"	3000	SAE 8	1"	28	217.39
214-350	3"	12"	1-1/4"	22-1/4"	34-1/4"	3000	SAE 8	1"	32	225.38
214-351	3"	14"	1-1/2"	24-1/4"	38-1/4"	3000	SAE 8	1"	35	233.38
214-353	3"	16" ASAE	1-1/2"	31-1/2"	47-1/2"	3000	SAE 8	1-1/4"	40	278.71
214-355	3"	20"	1-1/2"	30-1/4"	50-1/4"	3000	SAE 8	1"	43	252.25
214-357	3"	24"	1-1/2"	34-1/4"	58-1/4"	3000	SAE 8	1"	47	294.85
214-373	3-1/2"	8" ASAE	1-1/2"	20-1/4"	28-1/4"	3000	SAE 8	1"	29	222.74
214-374	3-1/2"	10"	1-1/2"	20-1/4"	30-1/4"	3000	SAE 8	1"	35	333.46
214-375	3-1/2"	12"	1-1/2"	22-1/4"	34-1/4"	3000	SAE 8	1"	37	350.16
214-376	3-1/2"	14"	1-1/2"	24-1/4"	38-1/4"	3000	SAE 8	1"	40	359.09
214-378	3-1/2"	16" ASAE	1-1/2"	31-1/2"	47-1/2"	3000	SAE 8	1-1/4"	48	378.54
214-382	3-1/2"	24"	1-1/2"	34-1/4"	58-1/4"	3000	SAE 8	1"	53	374.05
214-397	4"	8" ASAE	1-1/2"	20-1/4"	28-1/4"	3000	SAE 8	1"	33	358.38
214-398	4"	10"	1-1/2"	20-1/4"	30-1/4"	3000	SAE 8	1"	45	335.68
214-399	4"	12"	1-1/2"	22-1/4"	34-1/4"	3000	SAE 8	1"	49	401.74
214-434	4"	14"	2"	24-1/4"	38-1/4"	3000	SAE 8	1"	44	429.64
214-401	4"	16" ASAE	2"	31-1/2"	47-1/2"	3000	SAE 8	1-1/4"	59	450.37
214-403	4"	20"	2"	30-1/4"	50-1/4"	3000	SAE 8	1"	53	494.96
214-405	4"	24"	2"	34-1/4"	58-1/4"	3000	SAE 8	1"	79	466.76
214-420	5"	8" ASAE	2"	20-1/4"	28-1/4"	3000	SAE 12	1-1/4"	65	655.11
214-428	5"	24"	2-1/4"	36-1/4"	60-1/4"	3000	SAE 12	1-1/4"	127	821.63
214-430	5"	30"	2-1/4"	42-1/4"	72-1/4"	3000	SAE 12	1-1/4"	142	1027.72

Order No.	Bore	Stroke*	Rod	Dimensions		Rated PSI	Port Size	Pin Dia.	Wt. Lbs.	List
			Dia.	Retracted	Extended					
218-300	2"	8" ASAE	1-1/8"	20-1/4"	28-1/4"	2500	3/8" NPT	1"	19	\$136.95
218-309	2"	16"	1-1/8"	26-1/4"	42-1/4"	2500	3/8" NPT	1"	25	179.49
218-301	2-1/2"	8" ASAE	1-1/8"	20-1/4"	28-1/4"	2500	3/8" NPT	1"	22	158.33
218-322	2-1/2"	16"	1-1/8"	26-1/4"	42-1/4"	2500	3/8" NPT	1"	27	198.42
218-302	3"	8" ASAE	1-1/4"	20-1/4"	28-1/4"	2500	1/2" NPT	1"	29	171.86
218-340	3"	16" ASAE	1-1/4"	31-1/2"	47-1/2"	2500	1/2" NPT	1-1/4"	34	213.02
218-303	3-1/2"	8" ASAE	1-1/4"	20-1/4"	28-1/4"	2500	1/2" NPT	1"	32	198.61
218-354	3-1/2"	16" ASAE	1-1/2"	31-1/2"	47-1/2"	2500	1/2" NPT	1-1/4"	37	277.41
218-304	4"	8" ASAE	1-1/2"	20-1/4"	28-1/4"	2500	1/2" NPT	1"	39	243.03
218-365	4"	16" ASAE	2"	31-1/2"	47-1/2"	2500	1/2" NPT	1-1/4"	46	314.63

\*ASAE - Rod is threaded for mechanical depth control.



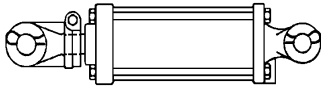

## Rockford Hydraulic Cylinders

### Rockford 2500 Series

DOUBLE ACTING TIE ROD TYPE CYLINDERS  
 Pressure rating: 2500 PSI maximum pressure, 4000 PSI maximum shock and surge pressure. Piston and cylinder head casting high tensile strength gray iron. Base casting and rod clevis ductile iron. Heavy duty "O" ring seals with back up rings on piston and rod. Rods: induction hardened C1045 steel alloy, hard chrome, plated and polished. Barrel: precision honed C1020 steel alloy.

Order No.	Rod Diam.	Bore Diam.	Stroke	Retract C to C	Wt	Price
2014AR	1-1/16	2	14	24-1/4	26	\$131.61
5030AR	2	5	30	42-1/4	108	459.05

**Rockford Hydraulic Cylinders are only available while quantities last!**

#### ROCKFORD SEAL KITS

Order No.	Bore	Rod Dia.	Price
063-0000-001	2"	1-1/16" (Std.)	\$20.00
063-0000-002	2-1/2"	1-1/16" (Std.)	25.48
063-0000-006	5"	1-1/2" (Std.)	95.16
063-0000-007	2"	1-1/8"	30.11
063-0000-008	2-1/2"	1-1/4"	25.90
063-0000-010	3-1/2"	1-1/2"	46.53
063-0000-012	5"	2"	103.38
063-0000-013	4"	2"	60.64



#### HYDRAULIC CYLINDER CLEVIS ENDS Female Threads

Order No.	Threads	Pin Size	Price
406-0000-014	1-1/16"-12	1"	\$22.49
276-000	1-1/8"-12	1"	53.92
276-001	1-1/4"-12	1"	54.21
276-028	1-1/4"-12	1-1/4"	79.05
276-002	1-1/2"-12	1-1/4"	74.14

#### ADJUSTABLE STROKE CONTROLS

No.	Fits Rod	Stroke Adjustment	Price
277-320	7/8"	2-1/4"	\$25.59
277-321	1-1/4"	2-1/4"	48.12



#### SPLIT HARDENED REDUCER BUSHING

Order No.	O.D.	I.D.	Price
210400084	1" Bushing	1-1/4"	\$12.78

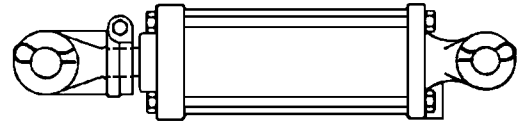

## EATON

### Field-Mate Hydraulic Cylinders

DOUBLE ACTING TIE ROD TYPE CYLINDERS  
 2500 PSI Rating, ASAE Rated, Ductile Iron Piston, Chrome Plated Rod, Painted Black, Replacement Seal Kits Available. All Clevis Pins - 1", Ports: 2"-2-1/2"...3/8" NPT, 3" 5"...1/2" NPT.

Order No.	Rod Diam.	Bore Diam.	Stroke	Retract C to C	Wt	Price
E-3014FMH	1-1/4	3	14	24-1/4	35	128.35
E-3524FMH	1-1/2	3-1/2	24	34-1/4	54	177.75

#### FIELD-MATE SHORT RETRACTED CYLINDERS

E-S3016FMH	1-1/4	3	16	26-1/4	39	139.34
------------	-------	---	----	--------	----	--------

#### EATON FIELD-MATE Cylinders

are only available while quantities last!

#### EATON FIELD-MATE SEAL KITS

Order No.	Bore	Rod Dia.	Price
E-SK2000FM	2"	1-1/8"	\$22.95
E-SK2500FM	2-1/2"	1-1/8"	24.21
E-SK3516FM	3-1/2"	1-1/2"	28.84
E-SK4016FM	4"	2"	32.21
E-SK4024FM-1.5	4"	1-1/2"	30.74
E-SK4024FM-2	4"	2"	32.21
E-SK5000FM	5"	1-1/2"	33.48

#### CHIEF SEAL KITS

Order No.	Bore	Rod Dia.	PSI	Price
204-010	2"	1-1/8"	3000	\$43.16
204-011	2-1/2"	1-1/8"	3000	47.97
204-012	2-1/2"	1-1/4"	3000	51.14
204-013	3"	1-1/4"	3000	54.36
204-014	3"	1-1/2"	3000	55.94
204-015	3-1/2"	1-1/2"	3000	59.15
204-016	4"	1-1/2"	3000	67.13
204-018	4"	2"	3000	70.33
204-019	5"	2"	3000	73.52
204-020	5"	2-1/4"	3000	75.13
204-500	2"	1-1/8"	2500	36.75
204-501	2-1/2"	1-1/8"	2500	36.86
204-502	2-1/2"	1-1/4"	2500	41.95
204-503	3"	1-1/4"	2500	41.57
204-504	3"	1-1/2"	2500	45.59
204-505	3-1/2"	1-1/4"	2500	47.28
204-506	3-1/2"	1-1/2"	2500	47.29
204-507	4"	1-1/2"	2500	52.61
204-508	4"	2"	2500	52.53

## HYDRAULIC ACCESSORIES

### Hyd. Cylinder Clevis Pins

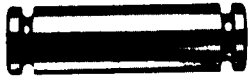

**NEW PRICES AS OF 6/10/2021**

Order No.	Description	Price
190400005	1" x 2-7/8" (Overall) Clevis Pin	\$3.25
190400001	1" x 3-1/2" (Overall) Clevis Pin	3.40
190400004	1" x 4" (Overall) Clevis Pin	3.98
190600016	1-1/4" x 4" (Overall) Clevis Pin	6.05
190600003	Hair Pin Clip (For Above Pins)	.39
210400084	Reducer Bushing 1-1/4" to 1" (for using 1" pins in 1-1/4" clevis)	12.78
HP-417-X	External Hair Pin Clip	.42

Note - Use #190400004 Pins on all 4" Cylinders

### Packing Repair Kits For Prince Hydraulic Cylinders

Order No.	Cylinder Series	Price
PMCK-Crown IC	Crown	\$9.90
PMCK-500	500	6.11
PMCK-600	600	10.56
PMCK-5400	5400	23.10
PMCK-7000	7000	16.76
PMCK-7100	7100	17.31
PMCK-8200	8200	35.79
PMCK-8300	8300	26.55
PMCK-8400	8400	15.61
PMCK-8600	8600	20.76
PMCK-9200	9200	17.80
PMCK-9300	9300	18.72
PMCK-9500	9500	36.35
PMCK-15208	15208	11.17

### Small Breathers



Model	Thread	WT.
BHF-3	1/2" NPT	3 oz.
BHF-4	3/8" NPT	3 oz.
BHF-6	3/4"-16 ORB	3 oz.

Plug-type breather/filter for converting double action unit to single action. Aluminum body contains two fine filter screens retained by stop washer. A low-cost, non-reusable, "throw-away" unit.

**NEW PRICES AS OF 6/10/2021**

Order No.	Description	Price
OHC-BHF-3	Small Breather, 1/2" NPT	\$6.39
OHC-BHF-4	Small Breather, 3/8" NPT	6.39
OHC-BHF-6	Small Breather, 3/4"-16 ORB	10.66

### Breather Filters



Model	NPT	WT.
BHF-1	1/2"	8 oz.

Primarily for use on a double action unit being used as a single action. Filters dirt out of cylinder end displacing air. Used often on oil reservoirs, or any part of hydraulic circuit where air is displaced. Filter material can be removed easily and cleaned for re-use. 1/2" NPT.

Order No.	Description	Price
OHC-BHF-1	Breather Filter, 1/2"	\$42.75

**We Ship  
Over 95%  
Of Our Orders  
The Same Day!**

**Centralize**  
your parts orders with  
**Central Supply**

Order Via Fax Toll-Free:

**1-800-342-7252**

# PIONEER QUICK COUPLING ADAPTERS

Pioneer adapters shown here provide the most reliable and exacting interchange in the industry.

## How To Connect Using An Adapter









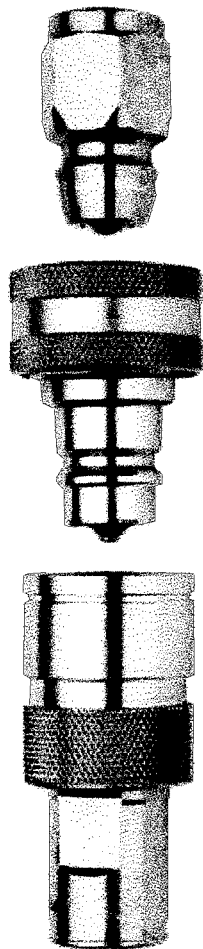

**STEP 1** Relieve trapped pressure in the implement line.

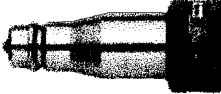
**STEP 2** Connect male tip on the implement line into the adapter.

**STEP 3** Connect the adapter into the female body.

**TO DISCONNECT** Reverse the above procedure: first disengage adapter from female body, then male tip from the adapter.



	Part No.	Adapts This Style Of Male Tip	To This Female Body
	4060-4	Pioneer Style	John Deere Old Style
	4065-4	John Deere Old Style	Pioneer Style
	4065-4L	John Deere Old Style	John Deere 50 Series Ford/ISO Pioneer 9250
	4067-4	John Deere Old Style	International Harvester Old Style
	4068-4	John Deere Old Style	J.I. Case Old Style
	4070-4	Pioneer Style	International Harvester Old Style
	4075-4	International Harvester Old Style	Pioneer Style
	4075-4L	International Harvester Old Style	John Deere 50 Series Ford/ISO Pioneer 9250
	4076-4	International Harvester Old Style	John Deere Old Style
	4080-4	Pioneer Style	J.I. Case Old Style
	4085-4	J.I. Case Old Style	Pioneer Style

*Call Central Toll-Free*  
**1-800-444-8666**

All Prices Are Subject To Change Without Notice

# Pioneer HYDRAULIC QUICK COUPLERS

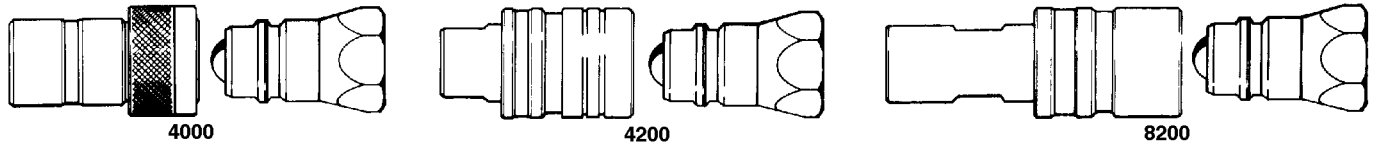

**4000 Series** offers exceptional dependability for demanding hydraulic applications where there is a absence of trapped pressure. Available in sizes from 1/4" to 1/2". Features a tight metal to metal seal.

**4100 Series** is similar to 4000 series with larger body size and increases flow capacity.

**4200 Series** is similar to the 4000 series but with double-acting sleeve. This unique sleeve allows easy one-hand connection when coupler is clamp mounted. Push to connect.

**5000 Series** is an economical coupling for application where uncoupling or recoupling under trapped pressure is a requirement. This is simply done with ordinary wrenches. No remote valving required.

**8200 Century II Series** lets you couple or uncouple implement or tractor with up to 2000 P.S.I. back pressure. Easy one hand connection when sleeve is clamp mounted. No wrenches needed.

Complete SAE Threads						Metal	Metal	Rubber	Rubber	
Coupler	Have O-Ring	Price	Body	Price	Male	Dust	Dust	Dust	Dust	"O"
Order No.	Boss	Each	Half No.	Each	Tip No.	Plug	Cap	Plug	Cap	Ring
4000-4	1/2 NPT	\$36.09	4050-4	\$25.73	8010-4	5005-4	5009-4	5205-4	5209-4	16
4000-5	3/4 NPT	51.73	4050-5	36.34	8010-5	5005-4	5009-4	5205-4	5209-4	16
4100-5*	3/4 NPT	100.17	4150-5	70.26	4110-5	N.A.	N.A.	5205-5	5209-5	215
4000-15	3/4-16 SAE	42.91	4050-15	30.21	8010-15	5005-4	5009-4	5205-4	5209-4	16
4000-16	7/8-14 SAE	49.76	4050-16	34.04	8010-16	5005-4	5009-4	5205-4	5209-4	16
4200-4	1/2 NPT	36.83	4250-4	26.49	8010-4	5005-4	5009-4	5205-4	5209-4	16
5000-4	1/2 NPT	64.69	5050-4	54.94	8010-4	5005-4	5009-4	5205-4	5209-4	16
8200-4	1/2 NPT	62.05	8250-4**	51.71	8010-4	5005-4	5009-4	5205-4	5209-4	**
8200-16	7/8-14 ORB	72.63	8250-16	57.66	8010-16	5005-4	5009-4	5205-4	5209-4	16

**BREAK-A-WAY Clamps** Shown and priced on next page may be used with all couplers except those with an asterisk (\*) in the above table.

\*\* 8250-4 Body uses Quad Seal #50005-211-0202

## JOHN DEERE COUPLERS AND ADAPTERS

	4056-4	Female body for John Deere, 1/2" NPTF (JD #AR98201)	\$40.70
	4056-16	Female body for John Deere, 3/4"-16 O-Ring Boss (JD #RE15361)	42.12
	5060-4	Male tip for John Deere, 1/2" NPTF (JD #RE11447)	15.22
	5060-15	Male tip for John Deere, 3/4"-16 O-Ring Boss (JD #AR93819 & #AR93820)	15.52
	4060-4	Adapter, Converts standard tips (Pioneer 8010 or comparable) to J.D. female half (JD #AR98201)	34.98
	4065-4	Adapter, Converts John Deere style tips to Pioneer style female half	41.29
<b>NOTE - - Can NOT be used with couplers that connect under pressure.</b>			
	4067-4	Adapter, Converts Deere style tips to IHC style female half (JD #RE11456)	41.45
	4068-4	Adapts a John Deere male tip to a old style Case female body	212.11
	4065-4L	Adapts old style John Deere male tips to 50 series John Deere Tractor ( JD #AR98202)	53.90
	4075-4L	Adapts International Harvester male tips to 50 series John Deere Tractor	95.79

## INTERNATIONAL COUPLERS AND ADAPTERS

	4057-4	International Harvester female body, 1/2" NPTF	49.27
	4070-4	Coupler, Converts standard tips (Pioneer 5010, 7010, 8010 or comparable) to International Harvester style female half	38.30
	4075-4	Coupler, Converts International Harvester style tips to Pioneer (or other interchangeable) female half	45.31
	4076-4	Coupler, Converts International Harvester style tips to John Deere style female half	62.37
	5070-4	Male tip for International Harvester, 1/2" NPTF	22.61
	5070-16	Male tip for International Harvester, 7/8-14 O-Ring Boss (IHC #544787-R91)	24.21
	5077-4	Male tip for old style International Harvester, 1/2" NPTF	20.05
	5077-16	Male tip for old style International Harvester, 7/8-14 O-Ring Boss	21.48

# Pioneer HYDRAULIC COUPLERS & ADAPTERS

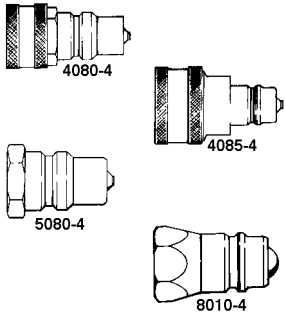

### CASE COUPLERS AND CONVERSIONS

4080-4	..... Adapts Standard tips (Pioneer 5010, 7010, 8010 or comparable) to a Case female half #28542 (Case std. before 1975)	\$47.56
4085-4	..... Adapts Case tip #A28541 (Case before 1975) to a Pioneer (or any other brand that interchanges with Pioneer) female half	118.81
5080-4	..... Male tip that completely interchanges with the old style Case tip #A28541. Features new Hi-Flo style poppet valve. Available with 1/2" tapered pipe thread which eliminated the need for a pipe adapter always needed with the old style Case tip	23.45
8010-4	..... Tip for the new FIEI std. with 1/2" tapered pipe thread. Has Hi-Flo shield around ball check valve. Mates perfectly with all Pioneer bodies and any other competitive body designed to accept the new FIEI std. tip	10.35

### ALLIS CHALMERS

SM-502-8FP	..... Old style Allis Chalmers male tip, 1/2 NPTF (Replaces #4610-4)	18.70
------------	--	-------

### FORD

8010-4P	..... Ford poppet style male tip, 1/2 NPTF	11.20
---------	--	-------

### MISCELLANEOUS

5011-4	..... Screw tip for 5050-4 female body	10.40
--------	--	-------



NEW PRICES AS OF 5/17/2021

### 9500 Series Couplers

The Pioneer 9500 series coupling has become the most widely used lever actuated coupling in the agricultural market. The 9500 series coupling permits connection even when both the tractor and implement levers are pressurized.

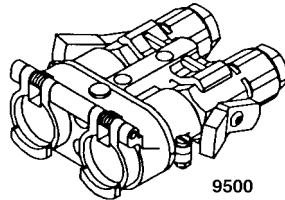

No.	Description	Price
9500-4	..... Kit, 1/2" NPTF	\$297.32
9250-4L	..... Yellow Body Only, 1/2" NPTF	130.09
9250-4R	..... Red Body Only, 1/2" NPTF	124.22
9500-16	..... Kit, 7/8"-14 O-Ring Boss	343.26
9250-16L	..... Yellow Body Only, 7/8"-14 O-Ring	116.42
9250-16R	..... Red Body Only, 7/8"-14 O-Ring	116.42
9006-4	..... Double Break-Away Clamp	30.37
9507-4-1H	..... Plastic Dust Cover	40.30

\* 9500 kit contains the following: 2 #9250 female bodies.  
1 #9507-4 automatic dust cover. 1 #9006-4 dbl. breakaway clamp.

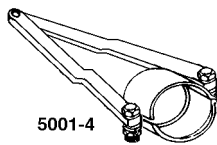
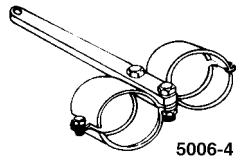

### BREAK - AWAY CLAMPS

Breakaway Clamps automatically uncouple the hydraulic lines thus preventing damage to any equipment or lines. It makes no difference whether implement is unhitched accidentally or intentionally. For use with female bodies that have 1-1/2" sleeves.

No.	Description	Price
5006-4	..... Double Break-Away Clamp	\$20.36
5001-4	..... Single Clamp	19.14

NOTE - - - Above break-away clamps may be used with all pioneer couplers except those marked with an (\*) asterisk on the preceding page.

DEALER SCHEDULE THIS PAGE.....203

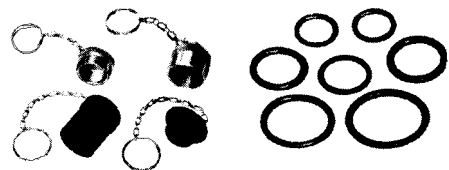

### DUST PLUGS - DUST CAPS - O-RINGS

No.	Description	Price
16	..... O-Ring Seal (Oil Resistant)	\$ .31
50001-215-0010	..... O-Ring Seal for #4150-5	1.74
50001-218-260	..... O-Ring Seal for #4050-6P	2.18
50005-211-0200	..... Quad Seal for #8250-4	1.86

### DUST PLUGS

5005-4	..... Dust Plug, 1/2" (Metal)	10.14
5205-2	..... Dust Plug, 1/4" (Rubber)	3.77
5205-3	..... Dust Plug, 3/8" (Rubber)	3.81
5205-4	..... Dust Plug, 1/2" (Rubber)	4.95
5205-5	..... Dust Plug, 3/4" (Rubber)	5.52
5205-6	..... Dust Plug, 1" (Rubber)	7.11

### DUST CAPS

5009-4	..... Dust Cap, 1/2" (Metal)	14.31
5209-2	..... Dust Cap, 1/4" (Rubber)	3.77
5209-3	..... Dust Cap, 3/8" (Rubber)	3.37
5209-4	..... Dust Cap, 1/2" (Rubber)	5.52
5209-5	..... Dust Cap, 3/4" (Rubber)	6.02
5209-6	..... Dust Cap, 1" (Rubber)	7.11

Call 1-800-444-8666

# Pioneer Poppet Style Quick Couplings

## Stop Hydraulic Leakage! With Poppet Style Quick Couplings

Poppet style valved couplings are ideal for applications where "bubble tight sealing" is desired on a tractor or farm implement to prevent uncoupled leakage of hydraulic fluids.

### Features

Poppet valving on both male and female halves. 8010 series poppet male tips meet ASAE #S366, SAE #J1036, and I.S.O. #5675 standard requirements. Steel construction with zinc and yellow chromate finish to help prevent corrosion. Bruna-N Nitrile seals. Connect-Under-Pressure nipples allow connection under residual pressure up to 3000 PSI.

### Specifications

1/4" - 1" body sizes. Interchangeable with std. Pioneer 4000 and 4200 Series Ball Valve Couplings. Operating Pressure: 3000 PSI

### Typical Applications

Agricultural tractors or various hydraulic-operated implements where uncoupled oil leakage is not acceptable.

NEW PRICES AS OF 5/7/2021

**Pioneer**  
The Farmer's Choice

Order No.	Description	Thread	Box Qty.	Price
4000-2P	Complete Coupling	1/4" NPTF	5	\$29.73
4000-3P	Complete Coupling	3/8" NPTF	5	38.98
4000-4P	Complete Coupling	1/2" NPTF	5	36.91
4000-15P	Complete Coupling	3/4"-16 ORB	5	46.83
4000-16P	Complete Coupling	7/8"-14 ORB	5	56.94
4000-6P	Complete Coupling	1" NPTF	5	123.54
4200-3P	Complete Coupling	3/8" NPTF	5	41.51
4200-4P	Complete Coupling	1/2" NPTF	5	40.66
4200-15P	Complete Coupling	3/4"-16 ORB	5	49.10

### Nipples

4010-2P	Male Tip	1/4" NPTF	10	9.55
4010-3P	Male Tip	3/8" NPTF	10	12.26
4010-6P	Male Tip	1" NPTF	10	40.89
8010-4P	Male Tip	1/2" NPTF	10	11.20
8010-15P	Male Tip	3/4"-16 ORB	10	15.10
DR10008*	Male Tip (1" Hex)	3/4"-16 ORB	10	10.11
8010-16P	Male Tip	7/8"-14 ORB	10	17.89

### Connect-Under-Pressure Nipples

8010-4P-DC	Male Tip	1/2"-14 NPTF	10	25.97
8010-15P-DC	Male Tip	3/4"-16 ORB	10	34.06

### Single Acting Sleeve Couplers

4050-2P	Female Half, Single Acting	1/4" NPTF	5	21.15
4050-3P	Female half, Single Acting	3/8" NPTF	5	28.00
4050-4P	Female Half, Single Acting	1/2" NPTF	5	25.73
4050-15P	Female Half, Single Acting	3/4"-16 ORB	5	32.77
4050-16P	Female Half, Single Acting	7/8"-14 ORB	5	40.89
4050-6P	Female Half, Single Acting	1" NPTF	5	86.68

### Double Acting Sleeve Couplers

4250-3P	Female Half, Double Acting	3/8" NPTF	5	31.07
4250-4P	Female Half, Double Acting	1/2" NPTF	5	29.47
4250-15P	Female Half, Double Acting	3/4"-16 ORB	5	35.11

\* Manufactured to meet the original J.D. dimensional specifications, and has a smaller hex size than a standard Pioneer tip.

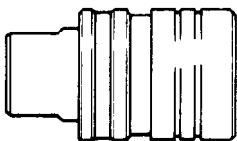
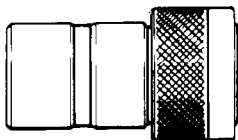
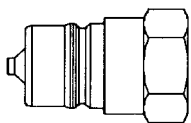

# Pioneer FEM & FF Non-Spill Couplings

FF & FEM series couplings were designed for the mobile equipment market and are used extensively on skid steer loaders. The non-spill features eliminates hydraulic spillage and air inclusion when connecting or disconnecting hydraulic attachments. FF & FEM series are ideal for many other applications where hydraulic spillage is a concern and global interchangeability with other manufacturers is important.

### FF Series Coupler (Original Flush Face Design)

Order No.	Body Size	Thread Size	Overall Length	Hex Size	Largest Diameter	Rated Pressure	Price
FF-371-06FP	3/8"	3/8"-18 NPSF	2.39"	1.00"	1.20"	3000 psi	\$72.28
FF-371-08FO	3/8"	3/4"-16 UNF	2.82"	1.06"	1.20"	3000 psi	76.70
FF-371-08FP	3/8"	1/2"-14 NPSF	2.45"	1.06"	1.20"	3000 psi	78.51
FF-501-08FP	1/2"	1/2"-14 NPSF	2.67"	1.37"	1.58"	3000 psi	112.26
FF-501-10FO	1/2"	7/8"-14 ORB	2.86"	1.37"	1.58"	3000 psi	112.45
FF-751-12FO	3/4"	1-1/16"-12 ORB	3.73"	1.75"	1.94"	3000 psi	170.66

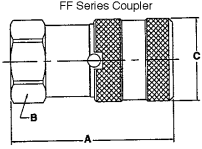

### FF Series Nipple (Original Flush Face Design)

Order No.	Body Size	Thread Size	Overall Length	Exposed Length	Hex Size	Largest Diameter	Rated Pressure	List Price
FF-372-06FP	3/8"	3/8"-18 NPSF	2.31"	1.80"	0.94"	1.08"	3000 psi	\$28.04
FF-372-08FO	3/8"	3/4"-16 UNF	2.70"	1.85"	1.06"	1.19"	3000 psi	32.32
FF-372-08FP	3/8"	1/2"-14 NPSF	2.44"	1.85"	1.06"	1.19"	3000 psi	31.94
FF-502-08FP	1/2"	1/2"-14 NPSF	2.75"	2.11"	1.12"	1.30"	3000 psi	48.85
FF-502-10FO	1/2"	7/8"-14 ORB	2.97"	2.29"	1.12"	1.30"	3000 psi	54.98
FF-752-12FO	3/4"	1-1/16"-12 ORB	3.58"	2.64"	1.50"	1.73"	3000 psi	105.94

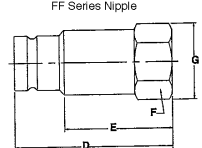

### FEM Series Coupler (Dimensioned to new ISO Standard)

Order No.	Body Size	Thread Size	Overall Length	Hex Size	Largest Diameter	Rated Pressure	Price
FEM-501-08FO-NL	1/2"	3/4"-16 UNF	2.89"	1.25"	1.54"	3000 psi	\$68.97
FEM-501-08FP-NL	1/2"	1/2"-14 NPSF	2.65"	1.38"	1.58"	3000 psi	84.15
FEM-501-10FO-NL	1/2"	7/8"-14 UNF	3.04"	1.25"	1.58"	3000 psi	76.62
FEM-501-12FO-NL	1/2"	1-1/16"-12 ORB	3.10"	1.38"	1.58"	3000 psi	95.51
FEM-621-12FO-NL	5/8"	1-1/16"-12 ORB	3.67"	1.62"	1.74"	3625 psi	74.38
FEM-751-12FO-NL	3/4"	1-1/16"-12 ORB	3.95"	46 MM	1.97"	3625 psi	130.77

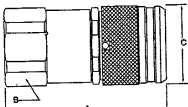

### FEM Series Nipple (Dimensioned to new ISO Standard)

Order No.	Body Size	Thread Size	Overall Length	Exposed Length	Hex Size	Largest Diameter	Rated Pressure	List Price
FEM-502-08FO	1/2"	3/4"-16 UNF	2.77"	1.96"	1.25"	1.50"	3000 psi	\$41.32
FEM-502-08FP	1/2"	1/2"-14 NPSF	2.77"	1.96"	1.25"	1.38"	3000 psi	41.09
FEM-502-10FO	1/2"	7/8"-14 UNF	2.85"	1.96"	1.38"	1.50"	3000 psi	38.64
FEM-502-12FO	1/2"	1-1/16"-12 ORB	3.05"	2.20"	1.38"	1.50"	3000 psi	41.04
FEM-622-12FO	5/8"	1-1/16"-12 ORB	3.40"	2.60"	1.50"	1.65"	3000 psi	60.74
FEM-752-12FO	3/4"	1-1/16"-12 ORB	3.38"	2.64"	46 MM	1.97"	3000 psi	75.70

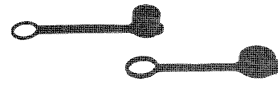
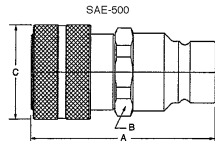
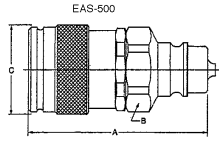
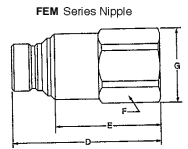

Note: Protective dust plugs and caps play a crucial role in the life of a quick coupling and no purchase of a hydraulic quick coupling is complete without the selection of an appropriate dust plug and cap.

### ADAPTERS

Order No.	Description	A	B	C	Price
EAS-500	1/2" Adapts FEM Series Male to 6600 Series Female	3.364"	1.380"	1.50"	\$170.21
SAE-500	Adapts 6600 Series Male to FEM Series Female	3.000"	1.250"	1.48"	213.17

### DUST PLUGS

No.	Description	Price
FR-501	FEM/FF Series Dust Plug, 1/2"	\$3.92
FR-751	FF Series Dust Plug, 3/4"	12.83

### DUST CAPS

No.	Description	Price
FER-502	FEM/FF Series Dust Cap, 1/2"	\$4.82

Pioneer	Faster	Holmby	Skid Steer Quick Coupling Interchange	Safeway	Melroe	Gehl	Deere	Case	New Holland	Mustang
FEM-501-08FP-NL	2FFJ12NPTF	FIMC38-NPT-1/2-F							86537647	
FEM-501-12FO-NL	2FFJ12-0/34SAEF	FIMC38-SAE-3/4-F		6667807	122846		X		86537659	X
FEM-621-12FO-NL									86537745	
FEM-502-08FP	2FFJ12NPTM	FIMC38-NPT-1/2-M							86537660	
FEM-502-12FO	2FFJ12-0/34SAEM	FIMC38-SAE-3/4-M		6667808	122845		X		86537658	X
FEM-622-12FO									86537746	
FF-501-10FO								143431A1		
FF-751-12FO								122179A1		
FF-502-10FP								122180A1		
FF-752-12FP								122178A1		
FE-501-10FO								390749A1		
EAS-500		FBIR806								
SAE-500		FBIR807								

# PIONEER QUICK COUPLING KITS

## 9500-4 Kit

Contains 9200 Series couplings and accessories.  
For connect and disconnect at zero pressure, even with pressurized lines.



9500 kit contains: (2) 9250 female bodies, (1) 9507-4-1H automatic dust covers, (1) 9006-4 double breakaway clamp

Kit No.	Description	Price
9500-4	Lever Coupler Kit, 1/2" NPTF	\$297.32

## 8500-4 Kit

Contains 8200 Series couplings and accessories.  
For connections having pressure on either tractor side of implement lines, or both.



8500 Kit contains: (2) 8250-4 female bodies, (2) 8010-4 male tips, (1) 5006-4 clamp, (2) 5209-4M dust caps, (2) 5205-4M dust plugs

Kit No.	Description	Price
8500-4	Break Away Kit, 1/2" NPTF	\$156.32

## 8700 Series ISO Conversion Kit

Upgrade International Harvester tractors to accept ISO male tips models 1971 to 1983.  
Converts lever style tractors to accept ISO interchange male tips  
Easy push/pull connect and disconnection  
Reduced pressure drop—longer system life  
Simple, fast Installation  
Patented dust cap keeps dust and dirt out.



## DR10010 Kit (JD #RE206778)

Converts J.D. 4000 series for use with ISO 5675 Pioneer style tips.  
Eliminates the need for adapters.  
Easy push/pull operation  
Reduced pressure drop for longer system life  
Simple and fast installation  
Chromium 6 Free plating for excellent corrosion resistance.



Kit No.	Description	Price
DR10010	JD RE206778 Conversion Kit	\$175.97

Kit No.	Description	Price
8700	ISO Conversion Kit	\$206.52

Dealer Schedule.....203

PRICES AS SHOWN 2021

# HYDRAULIC MULTIPLIERS

## Turn One Hydraulic Outlet Into Two or Three

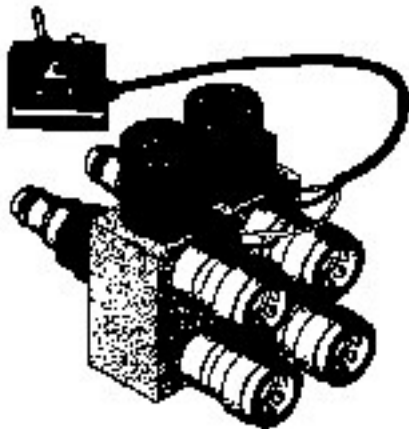

Two circuit shown with couplers

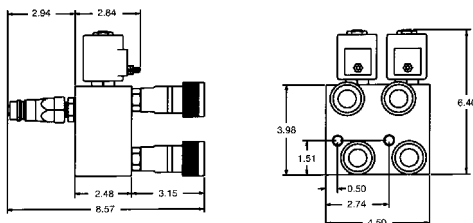

### Works on all makes....

of hydraulic systems, open, closed and PFC, as well as single and double acting circuits. They can be used with most types of hydraulic machinery, not just tractors. Operating Pressure - 3000 PSI, Flow - 0 to 15 GPM

**Electrohydraulic Valves** provide the operator hands on control from cab.

The circuit multiplier valve plugs directly into an existing remote outlet, turning one outlet into two. Eccentric fittings allow adjustment of male tips for different makes and models, or mounting holes in the manifold allow easy implement mounting.

**Switchbox** allows for simultaneous operation of circuits. Includes weatherproof enclosure with mounting bracket. Simple wiring harness included. Installations are quick and easy, taking less than one hour.

No.	Description	Wt.	Price
HM-14790	Two Circuit w/Couplers 12V DC	11.5	\$514.50
HM-12370	Three Circuit w/Couplers 12V DC	16.5	711.35
HM-14791	Two Circuit W/J.D Couplers	11.5	542.65
HM-18550	Two Circuit w/o Couplers 12V DC	8.5	466.50
HM-16930	Three Circuit w/o Couplers 12V DC	12.5	664.50
HM-653012	Solenoid Coil, 12V		60.00
HM-674001	Seal Kit		13.50
HM-610180	Eccentric Fitting		39.35

Dealer Schedule.....152



## Couplamatic Swage Hydraulic Hose Couplings

FOR 3/8" I.D. HOSE

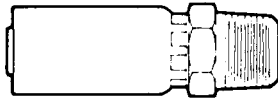

Part No.	Fits Hose O.D.	Fer- rule Size	Thread Size	Type	Price
601	13/16	27	1/4" Pipe	Solid Male	\$4.85
603	3/4	25	3/8" Pipe	Solid Male	4.40
604	13/16	27	3/8" Pipe	Solid Male	4.40

FOR 3/8" I.D. HOSE

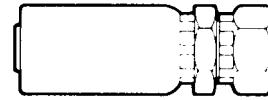

Part No.	Fits Hose O.D.	Fer- rule Size	Thread Size	Type	Price
630	3/4	25	3/4"-16 JIC 37	Swivel Fe.	\$6.05
632	7/8	29	3/4"-16 JIC 37	Swivel Fe.	6.05

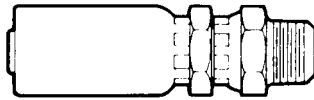

609	3/4	25	3/8" Pipe	Swivel Male	\$6.95
610	13/16	27	3/8" Pipe	Swivel Male	6.95
611	7/8	29	3/8" Pipe	Swivel Male	6.95
652	13/16	27	1/2" Pipe	Swivel Male	8.62



639	3/4	25	*3/4"-16 O-Ring	Solid Male	\$6.00
640	13/16	27	*3/4"-16 O-Ring	Solid Male	6.00
641	7/8	29	*3/4"-16 O-Ring	Solid Male	6.00



619	13/16	27	9/16"-18 JIC 37	Solid Male	\$5.22
621	3/4	25	3/4"-16 JIC 37	Solid Male	5.46
622	13/16	27	3/4"-16 JIC 37	Solid Male	5.46
623	7/8	29	3/4"-16 JIC 37	Solid Male	5.46

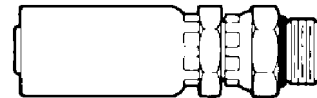

645	3/4	25	*3/4"-16 O-Ring	Swivel Male	\$7.80
646	13/16	27	*3/4"-16 O-Ring	Swivel Male	7.80

\*Special for John Deere (Furnished with O-Ring).

NOTE: All couplings on this page can be used on hose 1/32" larger or 1/32" smaller than O.D. shown.

PRICES ARE SUBJECT TO CHANGE WITHOUT NOTICE.

Dealer Schedule.....405

**We Ship  
Over 95%  
Of Our Orders  
The Same Day!**

### Clamp Type Hydraulic Couplings

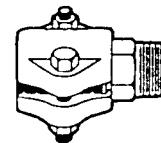

REUSABLE CLAMP TYPE COUPLINGS (COMPLETE)

No.	Hose I.D.	IPT Male	Price
604C	3/8"	3/8"	\$11.50
1204C	3/4"	3/4"	21.69

Dealer Schedule.....405

Couplamatic Continued On Next Page

## Couplamatic Swage Hydraulic Hose Couplings

FOR 1/2" I.D. HOSE

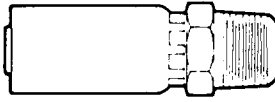

Part No.	Fits Hose		Thread Size	Type	Price
	O.D. ***	Fer-rule Size			
800	7/8	29	3/8" Pipe	Solid Male	\$5.63
801	15/16	31	3/8" Pipe	Solid Male	5.63
802	1	33	3/8" Pipe	Solid Male	5.63

FOR 1/2" I.D. HOSE



Part No.	Fits Hose		Thread Size	Type	Price
	O.D. ***	Fer-rule Size			
824	7/8	29	3/4"-16 JIC 37	Swivel Fe.	\$7.00
825	15/16	31	3/4"-16 JIC 37	Swivel Fe.	7.00

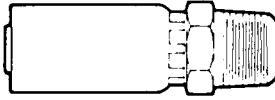

803	7/8	29	1/2" Pipe	Solid Male	\$5.14
805	1	33	1/2" Pipe	Solid Male	5.14



827	7/8	29	7/8"-14 JIC 37	Swivel Fe.	\$7.15
829	1	33	7/8"-14 JIC 37	Swivel Fe.	7.15

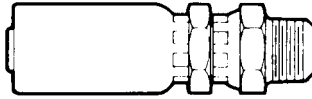

809	7/8	29	1/2" Pipe	Swivel Male	\$8.17
810	15/16	31	1/2" Pipe	Swivel Male	8.17
811	1	33	1/2" Pipe	Swivel Male	8.17

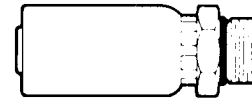

830	7/8	29	*3/4"-16 O-Ring	Solid Male	\$6.03
831	15/16	31	*3/4"-16 O-Ring	Solid Male	6.03
832	1	33	*3/4"-16 O-Ring	Solid Male	6.03

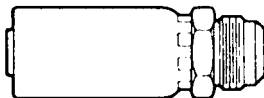

816	15/16	31	3/4"-16 JIC 37	Solid Male	\$6.23
818	7/8	29	7/8"-14 JIC 37	Solid Male	6.77
819	15/16	31	7/8"-14 JIC 37	Solid Male	6.77
820	1	33	7/8"-14 JIC 37	Solid Male	6.77



833	7/8	29	**7/8"-14 O-Ring	Solid Male	\$7.82
834	15/16	31	**7/8"-14 O-Ring	Solid Male	7.82

FOR 1/4" I.D. HOSE



Part No.	Fits Hose		Thread Size	Type	Price
	O.D. ***	Fer-rule Size			
401	5/8	21	1/8" Pipe	Solid Male	\$4.25
404	5/8	21	1/4" Pipe	Solid Male	4.20
407	5/8	21	1/4" Pipe	Swivel Male	6.66
416	5/8	21	3/8" Pipe	Solid Male	4.75
419	5/8	21	7/16"-20 JIC 37	Solid Male	4.70

\*Special for John Deere (Furnished with O-Ring).  
 \*\*Special for IHC (Furnished with O-Ring).  
 \*\*\*All couplings on this page can be used on hose 1/32" larger or 1/32" smaller than O.D. shown.

DEALER SCHEDULE THIS PAGE.....405

**Call Toll-Free 1-800-444-8666**

PRICES SUBJECT TO CHANGE WITHOUT NOTICE

## VARI-Crimp System

**Machinery Data:** House of Hose, Imperial-Eastman, Weatherhead, Gates

### Vari-Crimp Data Charts for Crimping with HH09

Hose Description	Hose I.D.	HH09 Gauge Setting	HH09 DIE Set	Vari-Crimp Coupling Placement	Coupling Crimp O.D.
One Wire Braid 100R1 AT (Thin Cover) and AgTrac 2500	3/16"	32	.450	.500 Below Flush	.530
	1/4"	30	.450	Flush	.560
	3/8"	31	.650	Flush	.745
	1/2"	21	.650	Flush	.875
	3/4"	24	.950	Flush	1.125
1"	34	1.400	Flush	1.490	
Two Wire Braid 100R2 AT (Thin Cover)	3/16"	28	.450	.500 Below Flush	.575
	1/4"	23	.450	Flush	.625
	3/8"	26	.650	Flush	.788
	1/2"	19	.650	Flush	.905
	5/8"	29	.950	Flush	1.050
3/4"	15	.950	Flush	1.215	
1"	32	1.400	Flush	1.500	
FarmTrac 2500 Thermoplastic Hydraulic Hose (2500 P S I WP)	3/8"	32	.650	Flush	.750
	1/2"	21	.650	Flush	.906

Hose Description	Hose I.D.	HH09 Gauge Setting	HH09 DIE Set	Vari-Crimp Coupling Placement	Coupling Crimp O.D.
Two Rayon Braid 100R3 Hydraulic Hose	1/4"	25	.450	Flush	.610
	3/8"	26	.650	Flush	.785
	1/2"	15	.650	Flush	.940
	3/4"	13	.950	Flush	1.235
1"	28	1.400	Flush	1.525	
Hydraulic Suction 100R4	3/4"	10	.950	Flush	1.230
	1"	28	1.400	Flush	1.520
Freon Hose Two Braid	5/16" (#6)	30	.650	1/4" below flush	.750
	13/32" (#8)	20	.650	1/4" below flush	.890
	1/2" (#10)	34	.950	1/4" below flush	1.000
	5/8" (#12)	24	.950	1/4" below flush	1.140

### Vari-Crimp Data Charts for Crimping with Imperial-Eastman and Weatherhead Machinery

Hose Description	Crimp data for a Vari-Crimp Coupling on an Imperial-Eastman Crimping Machine.						Crimp data for a Vari-Crimp Coupling on a Weatherhead T-400 Crimping Machine.				Typical Weatherhead spacer ring illustrating both sides of the ring.  Flat Side  Counterbore Side	
	Hose I.D.	K-20		All Others		K-20 & All Others Coupling Placement	Ring Number					
		Gauge Setting	Die Set	Gauge Setting	Die Set		Black (T-400-10)		Silver (T-400-11)			
							Counter-bore Side Up	Flat Side Up	Counter-bore Side Up	Flat Side Up		
One Wire Braid SAE 100R1 AT (Thin Cover)	1/4"	30	.450	69	.500	Flush	1/4"	3/8"	1/4"	3/8"		
	3/8"	31	.650	56	.500	Flush	3/8"	1/2"	3/8"	1/2"		
	1/2"	21	.650	46	.500	Flush	1/2"	5/8"	5/8"	5/8"		
	5/8"	34	.950	38	.500	Flush	5/8"	3/4"	3/4"	3/4"		
	3/4"	24	.950	70	1.050	Flush	3/4"	1"	1"	1"		
	1"	34	1.400	46	1.050	Flush	1"	1-1/4"	1-1/4"	1-1/4"		
1-1/4"	14	1.500	—	—	5/16" Below Flush	1-1/4"	—	—	—	—		
Two Wire Braid SAE 100R2 AT (Thin Cover)	1/4"	23	.450	64	.500	Flush		1/4"				
	3/8"	26	.650	52	.500	Flush		3/8"				
	1/2"	19	.650	44	.500	Flush		1/2"				
	5/8"	29	.950	35	.500	Flush		5/8"				
	3/4"	20	.950	66	1.050	Flush		3/4"				
	1"	32	1.400	44	1.050	Flush		1"				1"
1-1/4"	—	—	—	—	—		1-1/4"					

NOTE: No changes have been made in the manufacturers recommended crimp settings.

### Vari-Crimp Data Charts for Crimping with Gates Power Crimp 601

Hose Description	Hose I.D.	Approximate Gauge Setting	DIE Set	Coupling Placement	Coupling Crimp O.D.
One Wire Braid 100R1AT (Thin Cover)	1/4"	3	No. .02	1/4" Below Flush	.560
	3/8"	1-3/4	No. 2	3/8" Below Flush	.745
	1/2"	1-1/2	No. 3	5/16" Below Flush	.875
	5/8"	5-1/2	No. 3	3/16" Below Flush	1.000
	3/4"	1-1/2	No. 5	Flush With Die	1.125
1"	7	No. 6	3/16" Below Flush	1.490	
Two Wire Braid 100R2AT (Thin Cover)	1/4"	1	No. 1	1/4" Below Flush	.615
	3/8"	3	No. 2	3/8" Below Flush	.788
	1/2"	2-1/2	No. 3	5/16" Below Flush	.905
	5/8"	7	No. 3	3/16" Below Flush	1.050
	3/4"	3	No. 5	Flush with Die	1.180
	1"	1	No. 8	3/16" Below Flush	1.500

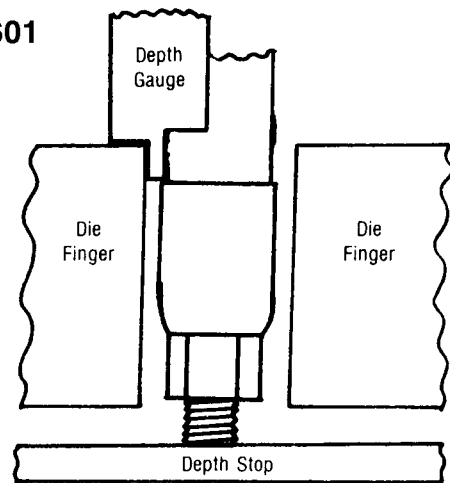

Before crimping, adjust Depth Stop up or down to establish the correct distance between the top surfaces of the die fingers and the top edges of the ferrule using the depth gauge available for Vari-Crimp Couplings. To determine the correct dimensions refer to the "Couplings Placement" column in the crimp chart.

On the one inch I.D. hose it is necessary to remove the depth stop gauge from the machine to avoid damage to it. If it is not removed, it may be bent in the crimping process. When crimping all couplings, make sure that the nut on the depth stop gauge is turned all the way up so that there is spring action in the depth gauge.

**Call Toll-Free  
1-800-444-8666**

## Couplamatic VARI-CRIMP HYDRAULIC HOSE ENDS

For House of Hose, Weatherhead, Imerial-Eastman & Gates Crimp Machines. For Thin Cover Hose Only.

### IPT SOLID MALE

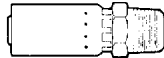

Order No.	Old No.	Hose I.D.	Pipe Size	Thread Size	Price
CS01-04-02	400V	1/4"	1/8"	1/8"-27	\$5.00
CS01-04-04	403V	1/4"	1/4"	1/4"-18	5.15
CS01-04-06	415V	1/4"	3/8"	3/8"-18	5.85
CS01-04-08	439V	1/4"	1/2"	1/2"-14	9.30
CS01-06-04	600V	3/8"	1/4"	1/4"-18	5.85
CS01-06-06	603V	3/8"	3/8"	3/8"-18	6.85
CS01-06-08	615V	3/8"	1/2"	1/2"-14	6.85
CS01-08-06	800V	1/2"	3/8"	3/8"-18	7.00
CS01-08-08	803V	1/2"	1/2"	1/2"-14	6.60
CS01-08-12	854V	1/2"	3/4"	3/4"-14	11.60
CS01-12-08	1200V	3/4"	1/2"	1/2"-14	15.25
CS01-12-12	1203V	3/4"	3/4"	3/4"-14	11.85
CS01-16-16	1600V	1"	1"	1"-11-1/2	16.85

### JIC 37° SOLID MALE



Order No.	Old No.	Hose I.D.	Thread Size	Tube O.D.	Price
CS08-04-04	418V	1/4"	7/16"-20	1/4"	\$6.05
CS08-04-05	421V	1/4"	1/2"-20	5/16"	6.15
CS08-04-06	430V	1/4"	9/16"-18	3/8"	6.70
CS08-06-06	618V	3/8"	9/16"-18	3/8"	6.75
CS08-06-08	621V	3/8"	3/4"-16	1/2"	7.00
CS08-06-10	669V	3/8"	7/8"-14	5/8"	10.30
CS08-08-08	815V	1/2"	3/4"-16	1/2"	8.00
CS08-08-10	818V	1/2"	7/8"-14	5/8"	8.75
CS08-08-12	848V	1/2"	1-1/16"-12	3/4"	12.75
CS08-12-10	1218V	3/4"	7/8"-14	5/8"	24.00
CS08-12-12	1215V	3/4"	1-1/16"-12	3/4"	12.70
CS08-12-14	1260V	3/4"	1-3/16"-12	7/8"	17.55
CS08-12-16	1233V	3/4"	1-5/16"-12	1"	18.20
CS08-16-16	1612V	1"	1-5/16"-12	1"	20.75

### IPT SWIVEL FEMALE

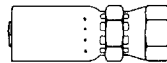

CS05-04-04	409V	1/4"	1/4"	1/4"-18	\$7.85
CS05-06-06	606V	3/8"	3/8"	3/8"-18	9.30
CS05-06-08	648V	3/8"	1/2"	1/2"-14	12.70
CS05-08-08	806V	1/2"	1/2"	1/2"-14	14.50
CS05-12-12	1206V	3/4"	3/4"	3/4"-14	20.00
CS05-16-16	1606V	1"	1"	1"-11-1/2	29.45

### IPT SOLID FEMALE

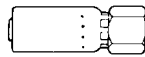

CS02-04-04	412V	1/4"	1/4"	1/4"-18	\$8.00
CS02-06-06	612V	3/8"	3/8"	3/8"-18	9.00
CS02-08-08	812V	1/2"	1/2"	1/2"-14	10.35

### IPT SWIVEL MALE



CS04-04-04	406V	1/4"	1/4"	1/4"-18	\$9.05
CS04-06-04	666V	3/8"	1/4"	1/4"-18	10.50
CS04-06-06	609V	3/8"	3/8"	3/8"-18	9.15
CS04-06-08	651V	3/8"	1/2"	1/2"-14	11.00
CS04-08-08	809V	1/2"	1/2"	1/2"-14	10.60
CS04-12-12	1209V	3/4"	3/4"	3/4"-14	17.70
CS04-16-16	1609V	1"	1"	1"-11-1/2	29.75

### 90° IPT SWIVEL MALE

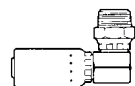

CS14-04-04	4206V	1/4"	1/4"	1/4"-18	\$18.40
CS14-06-06	6209V	3/8"	3/8"	3/8"-18	22.00
CS14-06-08	6251V	3/8"	1/2"	1/2"-14	25.45
CS14-08-08	8209V	1/2"	1/2"	1/2"-14	24.85

### JIC 37° SWIVEL FEMALE



CS09-04-04	424V	1/4"	7/16"-20	1/4"	\$6.30
CS09-04-05	427V	1/4"	1/2"-20	5/16"	6.60
CS09-04-06	433V	1/4"	9/16"-18	3/8"	6.45
CS09-06-06	627V	3/8"	9/16"-18	3/8"	6.90
CS09-06-08	630V	3/8"	3/4"-16	1/2"	7.30
CS09-06-10	657V	3/8"	7/8"-14	5/8"	10.05
CS09-08-08	824V	1/2"	3/4"-16	1/2"	9.15
CS09-08-10	827V	1/2"	7/8"-14	5/8"	9.50
CS09-08-12	845V	1/2"	1-1/16"-12	3/4"	16.15
CS09-12-10	1230V	3/4"	7/8"-14	5/8"	18.85
CS09-12-12	1221V	3/4"	1-1/16"-12	3/4"	14.85
CS09-12-14	1245V	3/4"	1-3/16"-12	7/8"	22.20
CS09-12-16	1236V	3/4"	1-5/16"-12	1"	21.60
CS09-16-16	1618V	1"	1-5/16"-12	1"	22.45

### SAE 45° SWIVEL FEMALE



CS07-06-06	633V	3/8"	5/8"-18	3/8"	\$7.45
------------	------	------	---------	------	--------

### SAE 45° SOLID MALE

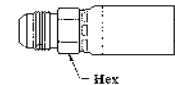

CS06-06-06	624V	3/8"	5/8"-18	3/8"	\$8.00
------------	------	------	---------	------	--------

### O-RING SOLID MALE



CS11-06-06	636V	3/8"	9/16"-18	3/8"	\$8.75
CS11-06-08	639V	3/8"	3/4"-16	1/2"	7.75
CS11-06-10	642V	3/8"	7/8"-14	5/8"	12.70
CS11-08-08	830V	1/2"	3/4"-16	1/2"	7.70
CS11-08-10	833V	1/2"	7/8"-14	5/8"	10.05
CS11-08-12	860V	1/2"	1-1/16"-12	3/4"	14.85
CS11-12-12	1227V	3/4"	1-1/16"-12	3/4"	15.95
CS11-16-16	1630V	1"	1-5/16"-12	1"	28.50

### O-RING SWIVEL MALE



CS12-06-08	645V	3/8"	3/4"-16	1/2"	\$11.75
CS12-08-08	836V	1/2"	3/4"-16	1/2"	12.30
CS12-08-10	839V	1/2"	7/8"-14	5/8"	12.85

NEW PRICES AS OF 10/10/2020

**Couplamatic VARI-CRIMP HYDRAULIC HOSE ENDS**

For House of Hose, Weatherhead, Imerial-Eastman & Gates Crimp Machines. For Thin Cover Hose Only.

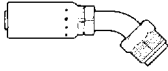

**45° BEND  
INVERTED FLARE**

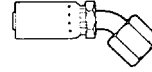

**45° BEND JIC  
SWIVEL FEMALE**

Order No.	Old No.	Hose I.D.	Thread Size	Tube O.D.	Drop Inches	Price
CS19-04-04 ...	4109V ...	1/4" ...	7/16"-24 ...	1/4" ...	0.948 ..	\$14.30
CS19-06-06 ...	6139V ...	3/8" ...	5/8"-18 ...	3/8" ...	1.016 ...	15.60
CS19-08-08 ...	8112V ...	1/2" ...	3/4"-18 ...	1/2" ...	1.154 ...	19.45

Order No.	Old No.	Hose I.D.	Thread Size	Tube O.D.	Drop Inches	Price
CS25-04-04 ...	4127V ...	1/4" ...	7/16"-20 ...	1/4" ...	0.711 ..	\$15.00
CS25-04-05 ...	4154V ...	1/4" ...	1/2"-20 ...	5/16" ...	0.895 ...	16.45
CS25-06-05 ...	6130V ...	3/8" ...	1/2"-20 ...	5/16" ...	0.895 ...	17.60
CS25-06-06 ...	6157V ...	3/8" ...	9/16"-18 ...	3/8" ...	0.988 ...	16.45
CS25-06-08 ...	6169V ...	3/8" ...	3/4"-16 ...	1/2" ...	0.710 ...	19.60
CS25-08-08 ...	8130V ...	1/2" ...	3/4"-16 ...	1/2" ...	0.710 ...	19.60
CS25-08-10 ...	8157V ...	1/2" ...	7/8"-14 ...	5/8" ...	0.839 ...	21.70

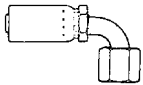

**90° BEND JIC  
SWIVEL FEMALE**

Order No.	Old No.	Hose I.D.	Thread Size	Tube O.D.	Drop Inches	Price
CS26-04-04 ...	4130V ...	1/4" ...	7/16"-20 ...	1/4" ...	1.453 ..	\$16.00
CS26-04-05 ...	4157V ...	1/4" ...	1/2"-20 ...	5/16" ...	1.540 ...	17.30
CS26-04-06 ...	4160V ...	1/4" ...	9/16"-18 ...	3/8" ...	1.125 ...	17.00
CS26-06-05 ...	6133V ...	3/8" ...	1/2"-20 ...	5/16" ...	1.540 ...	16.75
CS26-06-06 ...	6160V ...	3/8" ...	9/16"-18 ...	3/8" ...	1.822 ...	16.05
CS26-06-08 ...	6163V ...	3/8" ...	3/4"-16 ...	1/2" ...	1.375 ...	19.15
CS26-08-08 ...	8133V ...	1/2" ...	3/4"-16 ...	1/2" ...	1.945 ...	19.75
CS26-08-10 ...	8160V ...	1/2" ...	7/8"-14 ...	5/8" ...	1.825 ...	23.60
CS27-08-10 ...	8166V ...	1/2" ...	7/8"-14 ...	5/8" ...	2.750 ...	22.15
CS26-12-12 ...	12651V ..	3/4" ..	1-1/16"-12 ...	3/4" ...	1.880 ...	33.45

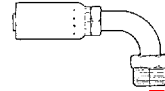

**90° BEND  
INVERTED FLARE**

Order No.	Old No.	Hose I.D.	Thread Size	Tube O.D.	Drop Inches	Price
CS20-04-04 ...	4112V ...	1/4" ...	7/16"-24 ...	1/4" ...	1.691 ..	\$14.65
CS20-04-05 ...	4139V ...	1/4" ...	1/2"-20 ...	5/16" ...	1.962 ...	15.75
CS20-06-05 ...	6115V ...	3/8" ...	1/2"-20 ...	5/16" ...	1.962 ...	15.70
CS20-06-06 ...	6142V ...	3/8" ...	5/8"-18 ...	3/8" ...	1.909 ...	16.00
CS20-08-10 ...	8142V ...	1/2" ...	7/8"-14 ...	5/8" ...	1.750 ...	23.60

**STRAIGHT INVERTED FLARE**



Order No.	Old No.	Hose I.D.	Thread Size	Tube O.D.	Price
CS18-04-04 ...	4106V ...	1/4" ...	7/16"-24 ...	1/4" ...	\$13.00
CS18-04-05 ...	4133V ...	1/4" ...	1/2"-20 ...	5/16" ...	13.45
CS18-06-05 ...	6109V ...	3/8" ...	1/2"-20 ...	5/16" ...	14.30
CS18-06-06 ...	6136V ...	3/8" ...	5/8"-18 ...	3/8" ...	14.30
CS18-08-08 ...	8109V ...	1/2" ...	3/4"-18 ...	1/2" ...	17.15

**TUBE REPAIR**

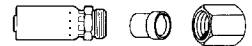

Order No.	Old No.	Hose I.D.	Thread Size	Tube O.D.	Price
CS28-04-04 ...	4100V ...	1/4" ...	7/16"-20 ...	1/4" ...	\$10.05
CS28-04-05 ...	4103V ...	1/4" ...	1/2"-20 ...	5/16" ...	11.90
CS28-06-05 ...	6103V ...	3/8" ...	1/2"-20 ...	5/16" ...	11.30
CS28-06-06 ...	6106V ...	3/8" ...	9/16"-18 ...	3/8" ...	10.60
CS28-06-08 ...	6800V ...	3/8" ...	3/4"-16 ...	1/2" ...	18.05
CS28-08-08 ...	8103V ...	1/2" ...	3/4"-16 ...	1/2" ...	12.40
CS28-08-10 ...	8106V ...	1/2" ...	7/8"-14 ...	5/8" ...	16.45

**90° O-RING SWIVEL MALE**

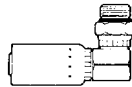

Order No.	Old No.	Hose I.D.	Thread Size	Tube O.D.	Price
CS15-06-08 ...	6245V ...	3/8" ...	3/4"-16 ...	1/2" ...	\$23.70
CS15-08-08 ...	8236V ...	1/2" ...	3/4"-16 ...	1/2" ...	26.60
CS15-08-10 ...	8239V ...	1/2" ...	7/8"-14 ...	5/8" ...	27.60

*Centralize With Central*

**Order Online at**

*CentralSupplyandRubber.com*

**STRAIGHT SAE SWIVEL FEMALE**



Part No.	Hose I.D.	Thread Size	Tube O.D.	Price
8118V ...	1/2" ...	3/4"-16 ...	1/2" ...	\$12.86

**STRAIGHT JIC SWIVEL FEMALE**



Part No.	Hose I.D.	Thread Size	Tube O.D.	Price
4124V ...	1/4" ...	7/16"-20 ...	1/4" ...	\$15.00
6127V ...	3/8" ...	1/2"-20 ...	5/16" ...	17.30

**HOSE SPLICER COUPLING**



Order No.	Old No.	Hose I.D.	Price
CS13-04-04 ...	44SV ...	1/4" ...	\$13.30
CS13-06-06 ...	66SV ...	3/8" ...	13.60
CS13-08-08 ...	88SV ...	1/2" ...	16.45

### Couplamatic VARI-CRIMP HYDRAULIC HOSE ENDS

For House of Hose, Weatherhead, Imerial-Eastman & Gates Crimp Machines. For Thin Cover Hose Only.

**STRAIGHT  
O-RING FACE SEAL  
SOLID MALE**



**45° BEND  
O-RING FACE SEAL  
SWIVEL FEMALE**

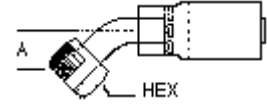

Order No.	Old No.	Hose I.D.	Thread Size	Tube O.D.	Price
CS29-04-04	04E64V	1/4"	9/16"-18	1/4"	\$10.32
CS29-06-06	06E66V	3/8"	11/16"-16	3/8"	10.97
CS29-06-08	06E68V	3/8"	13/16"-16	1/2"	16.61
CS29-08-08	08E68V	1/2"	13/16"-16	1/2"	12.89
CS29-08-10	08E70V	1/2"	1"-14	5/8"	16.67
CS29-08-12	08E72V	1/2"	1-3/16"-12	3/4"	51.21
CS29-10-10	10E70V	5/8"	1"-14	5/8"	21.23
CS29-10-12	10E72V	5/8"	1-3/16"-12	3/4"	29.77
CS29-12-12	12E72V	3/4"	1-3/16"-12	3/4"	26.01
CS29-16-16	16E76V	1"	1-7/16"-12	1"	50.82

Order No.	Old No.	Hose I.D.	Thread Size	Tube O.D.	Drop Inches	Price
CS31-04-04	04L64V	1/4"	9/16"-18	1/4"	0.41	\$18.54
CS31-04-06	04L66V	1/4"	11/16"-16	3/8"	0.43	18.45
CS31-06-06	06L66V	3/8"	11/16"-16	3/8"	0.43	19.06
CS31-06-08	06L68V	3/8"	13/16"-16	1/2"	0.60	22.32
CS31-08-06	08L66V	1/2"	11/16"-16	3/8"	0.43	25.90
CS31-08-08	08L68V	1/2"	13/16"-16	1/2"	0.59	22.32
CS31-08-10	08L70V	1/2"	1"-14	5/8"	0.68	25.84
CS31-10-10	10L70V	5/8"	1"-14	5/8"	0.68	27.34
CS31-10-12	10L72V	5/8"	1-3/16"-12	3/4"	0.83	33.63
CS31-12-10	12L70V	3/4"	1"-14	5/8"	0.68	42.59
CS31-12-12	12L72V	3/4"	1-3/16"-12	3/4"	0.83	35.10
CS31-12-16	12L76V	3/4"	1-7/16"-12	1"	1.15	60.76
CS31-16-16	16L76V	1"	1-7/16"-12	1"	1.15	50.63
CS31-20-20	20L80V	1-1/4"	1-11/16"-12	1-1/4"	1.07	115.20

**STRAIGHT  
O-RING FACE SEAL  
SWIVEL FEMALE**

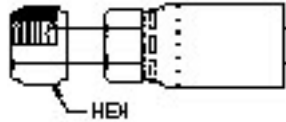

Order No.	Old No.	Hose I.D.	Thread Size	Tube O.D.	Price
CS30-04-04	04S64V	1/4"	9/16"-18	1/4"	\$12.97
CS30-04-06	04S66V	1/4"	11/16"-16	3/8"	13.49
CS30-04-08	04S68V	1/4"	13/16"-16	1/2"	18.07
CS30-06-04	06S64V	3/8"	9/16"-18	1/4"	15.97
CS30-06-06	06S66V	3/8"	11/16"-16	3/8"	12.54
CS30-06-08	06S68V	3/8"	13/16"-16	1/2"	13.63
CS30-08-06	08S66V	1/2"	11/16"-16	3/8"	16.61
CS30-08-08	08S68V	1/2"	13/16"-16	1/2"	15.42
CS30-08-10	08S70V	1/2"	1"-14	5/8"	18.76
CS30-08-12	08S72V	1/2"	1-3/16"-12	3/4"	28.33
CS30-10-10	10S70V	5/8"	1"-14	5/8"	21.45
CS30-10-12	10S72V	5/8"	1-3/16"-12	3/4"	27.41
CS30-12-10	12S70V	3/4"	1"-14	5/8"	26.50
CS30-12-12	12S72V	3/4"	1-3/16"-12	3/4"	27.76
CS30-12-16	12S76V	3/4"	1-7/16"-12	1"	31.28
CS30-16-16	16S76V	1"	1-7/16"-12	1"	42.48
CS30-20-20	20S80V	1-1/4"	1-11/16"-12	1-1/4"	66.00

DEALER SCHEDULE THIS PAGE... 405

*Centralize with Central*  
**CALL TOLL-FREE**  
**1-800-444-8666**

**At  
Central Supply  
We Ship  
Over 95%  
of our Orders  
The  
Same  
Day!**

All Prices Are Subject To Change Without Notice

**Couplamatic VARI-CRIMP HYDRAULIC HOSE ENDS**

For House of Hose, Weatherhead, Imerial-Eastman & Gates Crimp Machines. For Thin Cover Hose Only.

**90° BEND  
O-RING FACE SEAL  
SWIVEL FEMALE  
Medium Drop**

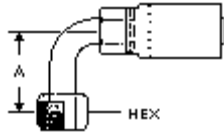

**90° BEND  
O-RING FACE SEAL  
SWIVEL FEMALE**

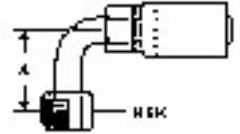

Order No.	Old No.	Hose I.D.	Thread Size	Tube O.D.	Drop Inches	Price
CS34-04-04	04J34V	1/4"	9/16"-18	1/4"	1.26	\$20.38
CS34-06-06	06J36V	3/8"	11/16"-16	3/8"	1.51	23.07
CS34-06-08	06J38V	3/8"	13/16"-16	1/2"	1.62	26.87
CS34-08-06	08J36V	1/2"	11/16"-16	3/8"	1.51	35.19
CS34-08-08	08J38V	1/2"	13/16"-16	1/2"	1.62	28.70
CS34-12-12	12J42V	3/4"	1-3/16"-12	3/4"	2.28	42.59
CS34-16-16	16J46V	1"	1-7/16"-12	1"	2.78	63.85
CS34-20-20	20J50V	1-1/4"	1-11/16"-12	1-1/4"	3.09	115.20

Order No.	Old No.	Hose I.D.	Thread Size	Tube O.D.	Drop Inches	Price
CS32-04-04	04A24V	1/4"	9/16"-18	1/4"	0.78	\$17.18
CS32-04-06	04A26V	1/4"	11/16"-16	3/8"	0.90	19.03
CS32-06-04	06A24V	3/8"	9/16"-18	1/4"	0.78	22.62
CS32-06-06	06A26V	3/8"	11/16"-16	3/8"	0.90	19.61
CS32-06-08	06A28V	3/8"	13/16"-16	1/2"	1.15	20.58
CS32-08-06	08A26V	1/2"	11/16"-16	3/8"	0.90	20.28
CS32-08-08	08A28V	1/2"	13/16"-16	1/2"	1.15	22.64
CS32-08-10	08A30V	1/2"	1"-14	5/8"	1.27	24.35
CS32-10-10	10A30V	5/8"	1"-14	5/8"	1.27	26.87
CS32-10-12	10A32V	5/8"	1-3/16"-12	3/4"	1.88	32.65
CS32-12-10	12A30V	3/4"	1"-14	5/8"	1.27	42.59
CS32-12-12	12A32V	3/4"	1-3/16"-12	3/4"	1.88	34.64
CS32-12-16	12A36V	3/4"	1-7/16"-12	1"	2.20	63.84
CS32-16-16	16A36V	1"	1-7/16"-12	1"	2.20	53.19
CS32-20-20	20A40V	1-1/4"	1-11/16"-12	1-1/4"	2.51	117.05

DEALER SCHEDULE THIS PAGE.....405

**Centralize**  
your parts orders with  
**Central Supply**

Order Via Fax Toll-Free:

**1-800-342-7252**

**NEW PRICES AS OF 10/10/2020**

**90° BEND  
O-RING FACE SEAL  
SWIVEL FEMALE  
Long Drop**

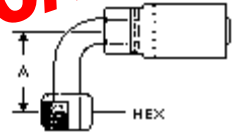

Order No.	Old No.	Hose I.D.	Thread Size	Tube O.D.	Drop Inches	Price
CS33-04-04	04A64V	1/4"	9/16"-18	1/4"	1.80	\$18.47
CS33-04-06	04A66V	1/4"	11/16"-16	3/8"	2.13	19.46
CS33-06-06	06A66V	3/8"	11/16"-16	3/8"	2.13	20.45
CS33-06-08	06A68V	3/8"	13/16"-16	1/2"	2.51	21.77
CS33-08-08	08A68V	1/2"	13/16"-16	1/2"	2.51	23.12
CS33-08-10	08A70V	1/2"	1"-14	5/8"	2.76	26.87
CS33-10-10	10A70V	5/8"	1"-14	5/8"	2.76	28.39
CS33-12-12	12A72V	3/4"	1-3/16"-12	3/4"	3.78	37.38
CS33-16-16	16A76V	1"	1-7/16"-12	1"	4.50	56.78

DEALER SCHEDULE THIS PAGE.....405

**You Can Rely On**  
**Central Supply**  
Order Online at  
[centralsupplyandrubber.com](http://centralsupplyandrubber.com)

**CALL TOLL-FREE**  
**1-800-444-8666**

All Prices Are Subject To Change Without Notice





## Couplamatic Hydraulic Adapters

For Hydraulic Control Hose Assemblies

### Male Pipe x Female Pipe NPSM

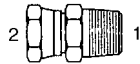

Order No.	Old P.N.	Ref. 1	Ref. 2	Price
1404-02-02	972	1/8"	1/8"	\$3.30
1404-02-04		1/8"	1/4"	4.04
1404-04-02		1/4"	1/8"	4.04
1404-04-04	973	1/4"	1/4"	3.91
1404-04-06	952	1/4"	3/8"	4.37
1404-06-04	968	3/8"	1/4"	4.38
1404-06-06	974	3/8"	3/8"	4.43
1404-06-08	954	3/8"	1/2"	5.42
1404-08-06	970	1/2"	3/8"	6.01
1404-08-08	975	1/2"	1/2"	4.97
1404-08-12	956	1/2"	3/4"	9.92
1404-12-08	955	3/4"	1/2"	9.64
1404-12-12	976	3/4"	3/4"	9.02
1404-12-16		3/4"	1"	17.05
1404-16-12		1"	3/4"	15.72
1404-16-16	977	1"	1"	14.42
1404-20-20		1-1/4"	1-1/4"	25.97
1404-24-24		1-1/2"	1-1/2"	41.39
1404-32-32		2"	2"	85.38

### Male Pipe x Female NPSM 90°

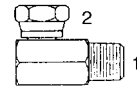

Order No.	Old P.N.	Ref. 1	Ref. 2	Price
1501-02-02	4972	1/8"	1/8"	\$4.74
1501-02-04		1/8"	1/4"	6.31
1501-04-02		1/4"	1/8"	6.34
1501-04-04	4973	1/4"	1/4"	5.10
1501-04-06		1/4"	3/8"	6.83
1501-06-04		3/8"	1/4"	7.13
1501-06-06	4974	3/8"	3/8"	6.83
1501-06-08	4954	3/8"	1/2"	8.78
1501-08-06	4970	1/2"	3/8"	8.22
1501-08-08	4975	1/2"	1/2"	8.21
1501-08-12		1/2"	3/4"	13.96
1501-12-08	4959	3/4"	1/2"	14.53
1501-12-12	4976	3/4"	3/4"	14.30
1501-12-16		3/4"	1"	34.09
1501-16-12	4978	1"	3/4"	25.72
1501-16-16	4977	1"	1"	23.33
1501-20-20		1-1/4"	1-1/4"	54.06
1501-24-24		1-1/2"	1-1/2"	86.00

### Restrictor (1/16" Orifice)

#### Male Pipe x Female Pipe Swivel



Order No.	Old P.N.	Ref. 1	Ref. 2	Price
1404-06-06-062		3/8"	3/8"	\$6.64
1404-08-08-062	975R-062	1/2"	1/2"	9.59

### Female Pipe x Female NPSM



Order No.	Old P.N.	Ref. 1	Ref. 2	Price
1405-02-02		1/8"	1/8"	\$3.48
1405-04-04	983	1/4"	1/4"	3.85
1405-06-06	984	3/8"	3/8"	5.27
1405-08-08	985	1/2"	1/2"	6.97
1405-12-12	986	3/4"	3/4"	10.43
1405-16-16	987	1"	1"	16.02
1405-20-20		1-1/4"	1-1/4"	31.63

### Male Pipe x Female NPSM 45°



Order No.	Ref. 1	Ref. 2	Price
1503-02-02	1/8"	1/8"	\$4.90
1503-04-04	1/4"	1/4"	5.44
1503-04-06	1/4"	3/8"	10.92
1503-06-04	3/8"	1/4"	7.20
1503-06-06	3/8"	3/8"	6.83
1503-06-08	3/8"	1/2"	13.73
1503-08-06	1/2"	3/8"	9.53
1503-08-08	1/2"	1/2"	9.38
1503-12-08	3/4"	1/2"	17.84
1503-12-12	3/4"	3/4"	14.09
1503-16-12	1"	3/4"	33.28
1503-16-16	1"	1"	24.49
1503-20-20	1-1/4"	1-1/4"	45.13
1503-24-24	1-1/2"	1-1/2"	76.89

### Female Pipe x Female NPSM 90°

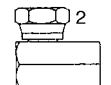

Order No.	Old P.N.	Ref. 1	Ref. 2	Price
1502-04-04	4983	1/4"	1/4"	\$6.22
1502-04-06		1/4"	3/8"	12.59
1502-06-04		3/8"	1/4"	9.26
1502-06-06	4984	3/8"	3/8"	8.60
1502-06-08		3/8"	1/2"	12.30
1502-08-06		1/2"	3/8"	11.70
1502-08-08	4985	1/2"	1/2"	10.67
1502-08-12		1/2"	3/4"	18.97
1502-12-08		3/4"	1/2"	19.68
1502-12-12	4986	3/4"	3/4"	17.15
1502-16-16		1"	1"	28.61
1502-20-20		1-1/4"	1-1/4"	58.52

### Restrictor - 1/16"

#### Male Pipe x Female Pipe Swivel 90°

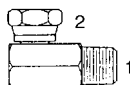

Order No.	Ref. 1	Ref. 2	Price
1501-06-06-062	3/8"	3/8"	\$11.76
1501-08-08-062	1/2"	1/2"	14.68

HYD. ADAPTERS CONTINUED ON THE NEXT PAGE

DEALER SCHEDULE THIS PAGE.....405

**Call Toll-Free 1-800-444-8666**

## Couplamatic Hydraulic Adapters

For Hydraulic Control Hose Assemblies

### Female Pipe x Female Pipe Coupling



Order No.	Old P.N.	NPT Ref.1	NPT Ref. 2	Price
5000-04-04		1/4"	1/4"	\$2.66
5000-06-04		3/8"	1/4"	4.63
5000-06-06	66FP	3/8"	3/8"	3.24
5000-08-06		1/2"	3/8"	5.62
5000-08-08	88FP	1/2"	1/2"	5.17
5000-12-08		3/4"	1/2"	8.35
5000-12-12		3/4"	3/4"	7.93
5000-16-16		1"	1"	14.34

### Male Pipe x Male Pipe Hex Nipple



Order No.	NPT Ref.1	NPT Ref. 2	Price
5404-02-02	1/8"	1/8"	\$1.76
5404-04-04	1/4"	1/4"	1.87
5404-06-06	3/8"	3/8"	2.45
5404-08-04	1/2"	1/4"	4.46
5404-08-06	1/2"	3/8"	3.74
5404-08-08	1/2"	1/2"	3.64
5404-12-12	3/4"	3/4"	6.29
5404-16-16	1"	1"	9.50

### Male Pipe x Female Pipe Hex Bushing



Order No.	Old P.N.	NPT Ref.1	NPT Ref. 2	Price
5406-06-04	64B	3/8"	1/4"	\$2.38
5406-08-02		1/2"	1/8"	4.03
5406-08-04	84B	1/2"	1/4"	3.35
5406-08-06	86B	1/2"	3/8"	3.12
5406-12-06	126B	3/4"	3/8"	4.96
5406-12-08	128B	3/4"	1/2"	5.05
5406-16-08	168B	1"	1/2"	7.62
5406-16-12	1612B	1"	3/4"	7.93

### Male Pipe Plug



Order No.	NPT Ref. 1	Price
5406-P04	1/4"	\$1.26
5406-P06	3/8"	1.49
5406-P08	1/2"	2.26
5406-P12	3/4"	4.21
5406-P16	1"	8.48

DEALER SCHEDULE THIS PAGE.....405

**To Order Call Toll-Free:**  
**1-800-444-8666**

### Male Pipe x Female NPSM Tee

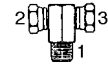

Order No.	Old P.N.	NPT Ref.1	Ref. 2&3	Price
1601-04-04-04		1/4"	1/4"	\$10.73
1601-06-06-06	666TM	3/8"	3/8"	14.14
1601-08-08-08	888TM	1/2"	1/2"	16.93
1601-12-12-12		3/4"	3/4"	25.90

### Female Pipe x Female NPSM Tee



Order No.	Old P.N.	NPT Ref.1	Ref. 2&3	Price
1602-04-04-04		1/4"	1/4"	\$12.68
1602-06-06-06	666TF	3/8"	3/8"	14.81
1602-08-08-08	888TF	1/2"	1/2"	21.14
1602-12-12-12		3/4"	3/4"	30.89

### Female NPSM x Female NPSM Tee



Order No.	NPT Ref.1	NPT Ref. 2&3	Price
1603-04-04-04	1/4"	1/4"	\$12.68
1603-06-06-06	3/8"	3/8"	14.57
1603-08-08-08	1/2"	1/2"	19.14
1603-12-12-12	3/4"	3/4"	31.57

### Male JIC x Male Pipe

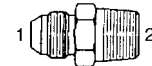

Order No.	Old P.N.	JIC Ref.1	NPT Ref. 2	Price
2404-04-02		7/16"-20	1/8"	\$1.72
2404-04-04		7/16"-20	1/4"	1.70
2404-05-02		1/2"-20	1/8"	2.39
2404-05-04		1/2"-20	1/4"	2.51
2404-06-04	J-43	9/16"-18	1/4"	1.87
2404-06-06	J-61	9/16"-18	3/8"	2.16
2404-06-08		9/16"-18	1/2"	3.24
2404-08-06	J-62	3/4"-16	3/8"	2.80
2404-08-08	J-81	3/4"-16	1/2"	3.44
2404-10-08	J-82	7/8"-14	1/2"	5.05
2404-12-12		1-1/16"-12	3/4"	5.89
2404-12-16		1-1/16"-12	1"	10.19

### Male JIC x Male Pipe 90°



Order No.	JIC Ref.1	NPT Ref. 2	Price
2501-06-06	9/16"-18	3/8"	\$5.16
2501-06-08	9/16"-18	1/2"	6.65
2501-08-06	3/4"-16	3/8"	6.91
2501-08-08	3/4"-16	1/2"	7.20
2501-10-08	7/8"-14	1/2"	9.10
2501-12-12	1-1/16"-12	3/4"	11.93

PRICES ARE SUBJECT TO CHANGE WITHOUT NOTICE.

## Couplamatic Hydraulic Adapters

For Hydraulic Control Hose Assemblies

### Male JIC x Male Pipe 45°



Order No.	JIC Ref. 1	NPT Ref. 2	Price
2503-06-06	9/16"-18	3/8"	\$8.05
2503-08-06	3/4"-16	3/8"	8.33
2503-08-08	3/4"-16	1/2"	9.31
2503-10-08	7/8"-14	1/2"	10.40

### JIC Plug



Order No.	JIC Ref. 1	Price
2408-04	7/16"-20	\$2.57
2408-06	9/16"-18	2.60
2408-08	3/4"-16	2.60
2408-10	7/8"-14	2.60
2408-12	1-1/16"-12	3.85

### Male JIC x Female Pipe

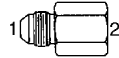

Order No.	Old P.N.	JIC Ref. 1	NPT Ref. 2	Price
2405-06-06		9/16"-18	3/8"	\$3.91
2405-08-06	6F-8JMS	3/4"-16	3/8"	4.20
2405-08-08	8F-8JMS	3/4"-16	1/2"	5.66
2405-10-08	8F-10JMS	7/8"-14	1/2"	7.01

### Male Pipe x Female JIC Swivel



Order No.	NPT Ref. 1	JIC Ref. 2	Price
6505-06-06	3/8"	9/16"-18	\$6.37
6505-06-08	3/8"	3/4"-16	9.10
6505-08-08	1/2"	3/4"-16	8.21
6505-08-10	1/2"	7/8"-14	10.06
6505-12-12	3/4"	1-1/16"-12	13.87

### Male JIC x Female JIC 90° Swivel



Order No.	JIC Ref. 1	JIC Ref. 2	Price
6500-06-06	9/16"-18	9/16"-18	\$6.22
6500-08-08	3/4"-16	3/4"-16	8.48
6500-10-10	7/8"-14	7/8"-14	12.22
6500-12-12	1-1/16"-12	1-1/16"-12	16.63

### Male ORB x Female NPSM



Order No.	Old P.N.	ORB Ref. 1	NPT Ref. 2	Price
6900-04-04		7/16"-20	1/4"	\$3.90
6900-06-04	87-6-4	9/16"-18	1/4"	4.14
6900-06-06	87-6-6	9/16"-18	3/8"	4.57
6900-08-06	87-8-6	3/4"-16	3/8"	5.42
6900-08-08	87-8-8	3/4"-16	1/2"	5.72
6900-10-08	87-10-8	7/8"-14	1/2"	7.20
6900-10-12		7/8"-14	3/4"	10.43
6900-12-12		1-1/16"-12	3/4"	10.98

### Male JIC x Male JIC

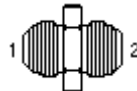

Order No.	JIC Ref. 1	JIC Ref. 2	Price
2403-04-04	7/16"-20	7/16"-20	\$1.75
2403-05-05	1/2"-20	1/2"-20	3.20
2403-06-06	9/16"-18	9/16"-18	2.22
2403-08-08	3/4"-16	3/4"-16	3.06
2403-10-10	7/8"-14	7/8"-14	4.82
2403-12-12	1-1/16"-12	1-1/16"-12	7.66

### Male ORB x Female Pipe NPSM 90°

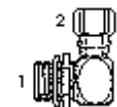

Order No.	Old P.N.	ORB Ref. 1	NPT Ref. 2	Price
6901-04-04		7/16"-20	1/4"	\$7.31
6901-06-04		9/16"-18	1/4"	7.87
6901-06-06	90-6-6	9/16"-18	3/8"	9.38
6901-08-06	90-8-6	3/4"-16	3/8"	10.16
6901-08-08	90-8-8	3/4"-16	1/2"	10.79
6901-10-08	90-10-8	7/8"-14	1/2"	12.85
6901-10-12		7/8"-14	3/4"	24.49
6901-12-12		1-1/16"-12	3/4"	22.84

### Male JIC x Male JIC 90°



Order No.	JIC Ref. 1	JIC Ref. 2	Price
2500-06-06	9/16"-18	9/16"-18	\$5.78
2500-08-08	3/4"-16	3/4"-16	7.60
2500-10-10	7/8"-14	7/8"-14	11.03

### Male ORB x Female Pipe NPSM 45°



Order No.	ORB Ref. 1	NPT Ref. 2	Price
6902-04-04	7/16"-20	1/4"	\$11.89
6902-06-04	9/16"-18	1/4"	11.76
6902-06-06	9/16"-18	3/8"	11.00
6902-08-06	3/4"-16	3/8"	13.06
6902-08-08	3/4"-16	1/2"	13.30
6902-10-08	7/8"-14	1/2"	15.53

### Male JIC x Male JIC Tee



Order No.	JIC Ref. 1	JIC Ref. 2&3	Price
2603-06-06-06	9/16"-18	9/16"-18	\$7.44
2603-08-08-08	3/4"-16	3/4"-16	9.08
2603-10-10-10	7/8"-14	7/8"-14	13.73
2603-12-12-12	1-1/16"-12	1-1/16"-12	19.62

## Couplamatic Hydraulic Adapters

For Hydraulic Control Hose Assemblies

### Male JIC x Male ORB



Order No.	JIC Ref. 1	ORB Ref. 2	Price
6400-04-04	7/16"-20	7/16"-20	\$1.82
6400-06-06	9/16"-18	9/16"-18	2.03
6400-06-08	9/16"-18	3/4"-16	2.95
6400-08-06	3/4"-16	9/16"-18	3.44
6400-08-08	3/4"-16	3/4"-16	3.29
6400-08-10	3/4"-16	7/8"-14	4.09
6400-08-12	3/4"-16	1-1/16"-12	6.46
6400-10-08	7/8"-14	3/4"-16	4.58
6400-10-10	7/8"-14	7/8"-14	4.64
6400-10-12	7/8"-14	1-1/16"-12	7.20
6400-12-10	1-1/16"-12	7/8"-14	7.08
6400-12-12	1-1/16"-12	1-1/16"-12	7.26
6400-16-16	1-5/16"-12	1-5/16"-12	10.73

### Male JIC x Male ORB 90°



Order No.	JIC Ref. 1	ORB Ref. 2	Price
6801-04-04	7/16"-20	7/16"-20	\$5.39
6801-06-06	9/16"-18	9/16"-18	6.12
6801-08-08	3/4"-16	3/4"-16	8.84
6801-08-10	3/4"-16	7/8"-14	10.78
6801-10-08	7/8"-14	3/4"-16	11.76

### Male ORB x Female ORB



Order No.	Old P.N.	ORB Ref. 1	ORB Ref. 2	Price
6410-08-10	878GH	3/4"-16	7/8"-14	\$5.98
6410-10-08	878CJ	7/8"-14	3/4"-16	4.96
6410-12-08		1-1/16"-12	3/4"-16	7.50

### Flat Face Male Tube Plug

SAE J1453 520109

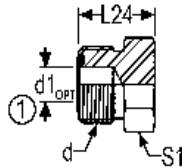

Order No.	Tube O.D.	d	UN/UNF-2A	L24	S1	Price
FF2408-04	1/4"	9/16"-18	0.66	0.63	\$1.74	
FF2408-06	3/8"	11/16"-16	0.74	0.75	1.91	
FF2408-08	1/2"	13/16"-16	0.86	0.88	2.49	
FF2408-10	5/8"	1"-14	1.02	1.06	3.83	
FF2408-12	3/4"	1-3/16"-12	1.08	1.25	4.00	
FF2408-16	1"	1-7/16"-12	1.10	1.50	6.66	
FF2408-20	1-1/4"	1-11/16"-12	1.10	1.75	10.14	
FF2408-24	1-1/2"	2"-12	1.10	2.13	12.43	

DEALER SCHEDULE THIS PAGE.....405

### Female ORB x Male Pipe

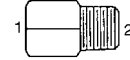

Order No.	Old P.N.	ORB Ref. 1	NPT Ref. 2	Price
6404-08-06	876FE	3/4"-16	3/8"	\$5.27
6404-08-08	876PO	3/4"-16	1/2"	5.10
6404-10-08	878FE	7/8"-14	1/2"	6.83
6404-12-12		1-1/16"-12	3/4"	13.69

### Male ORB x Female Pipe



Order No.	Old P.N.	ORB Ref. 1	NPT Ref. 2	Price
6405-06-06		9/16"-18	3/8"	\$4.91
6405-08-06	676MA	3/4"-16	3/8"	3.78
6405-08-08	876MA	3/4"-16	1/2"	5.89
6405-10-06	678MA	7/8"-14	3/8"	6.10
6405-10-08	878MA	7/8"-14	1/2"	6.41

### Female ORB x Female ORB



Order No.	Old P.N.	ORB Ref. 1	ORB Ref. 2	Price
6425-08-08	876JDF	3/4"-16	3/4"-16	\$10.66
6425-10-10	878IHF	7/8"-14	7/8"-14	11.66

### Female ORB x Female Pipe

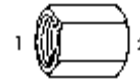

New P.N.	Old P.N.	ORB Ref. 1	NPT Ref. 2	Price
876FPO	876FPO	3/4"-16	3/8"	\$8.96
6420-08-08	876SPF	3/4"-16	1/2"	10.58
6420-10-08	878PO	7/8"-14	1/2"	13.07

### Male ORB x Male Pipe



Order No.	Old P.N.	ORB Ref. 1	NPT Ref. 2	Price
6401-06-06		9/16"-18	3/8"	\$2.99
6401-08-06	6MP-8MO	3/4"-16	3/8"	3.77
6401-08-08	8MP-8MO	3/4"-16	1/2"	4.26
6401-10-08	8MP-10MO	7/8"-14	1/2"	5.66

### Male ORB Plug



Order No.	ORB Ref. 1	Price
6408-04	7/16"-20	\$ .79
6408-05	1/2"-20	1.55
6408-06	9/16"-18	1.60
6408-08	3/4"-16	2.22
6408-10	7/8"-14	2.70
6408-12	1-1/16"-12	4.07

All Prices Are Subject To Change Without Notice.

**Order Online at**  
**www.CentralSupplyandRubber.com**

## Couplamatic Hydraulic Adapters

For Hydraulic Control Hose Assemblies

### Female Pipe x Female JIC Swivel

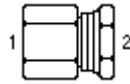

Order No.	Old P.N.	NPT Ref. 1	JIC Ref. 2	Price
6506-06-06	600	3/8"	9/16"-18	\$7.95
6506-06-08	8FJ-6FP	3/8"	3/4"-16	8.71
6506-08-06		1/2"	9/16"-18	9.66
6506-08-08	8FJ-8FP	1/2"	3/4"-16	8.44
6506-08-10	10FJ-8FP	1/2"	7/8"-14	11.04
6506-12-12		3/4"	1-1/16"-12	14.81

### Male Flat Face O-Ring x Male Pipe



Order No.	ORF Ref. 1	NPT Ref. 2	Price
4MOS-4MP	9/16"-18	1/4"	\$5.75
4MOS-6MP	9/16"-18	3/8"	6.54
6MOS-4MP	11/16"-16	1/4"	5.30
6MOS-6MP	11/16"-16	3/8"	5.64
6MOS-8MP	11/16"-16	1/2"	9.24
8MOS-6MP	13/16"-16	3/8"	6.90
8MOS-8MP	13/16"-16	1/2"	8.71
12MOS-12MP	1-3/16"-12	3/4"	13.82

### Male ORB x Female NPSM Tee



Order No.	ORB Ref. 1	NPT Ref. 2&3	Price
8MO-6TFP	3/4"-16	3/8"	\$15.17
10MO-8TFP	7/8"-14	1/2"	12.39

### Male Flat Face O-Ring x Male ORB



Order No.	ORF Ref. 1	ORB Ref. 2	Price
4MOS-4MO	9/16"-18	7/16"-20	\$5.30
6MOS-6MO	11/16"-16	9/16"-18	5.98
8MOS-8MO	13/16"-16	3/4"-16	7.68
12MOS-12MO	1-3/16"-12	1-1/16"-12	13.30

### 304-C Cap Nut

SAE J514 070112  
MS51532

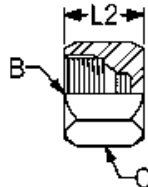

Order No.	Tube O.D.	B UN/UNF-2B	L2	C	Price
304-C-04	1/4"	7/16"-20	0.59	0.56	\$ .79
304-C-05	5/16"	1/2"-20	0.60	0.63	1.08
304-C-06	3/8"	9/16"-18	0.63	0.69	1.30
304-C-08	1/2"	3/4"-16	0.75	0.88	1.55
304-C-10	5/8"	7/8"-14	0.84	1.25	2.25
304-C-12	3/4"	1-1/16"-12	0.91	1.25	3.30

### Male Flat Face O-Ring x Male ORB 90°

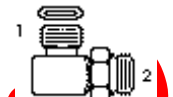

Order No.	ORF Ref. 1	ORB Ref. 2	Price
4MOS-4MO90	9/16"-18	7/16"-20	\$15.49
6MOS-6MO90	11/16"-16	9/16"-18	17.36
8MOS-8MO90	13/16"-16	3/4"-16	21.32
12MOS-12MO90	1-3/16"-12	1-1/16"-12	39.52

DEALER SCHEDULE THIS PAGE.....405

Dash Size	SAE 37° (JIC) N.P.T.F. hydraulic	SAE O-ring boss
-02	1/8-27	5/16-24
-03		3/8-24
-04	1/4-18	7/16-20
-05		1/2-20
-06	3/8-18	9/16-18
-07		
-08	1/2-14	3/4-16
-10		7/8-14
-12	3/4-14	1-1/16-12
-14		1-3/16-12
-16	1-11-1/2	1-5/16-12
-20	1-1/4-11-1/2	1-5/8-12
-24	1-1/2-11-1/2	1-7/8-12
-32	2-11-1/2	2-1/2-12
-40	2-1/2-8	3-12
-48	3-8	3-1/2-12

Adapter Part No. Abbreviations and Thread Size Chart

BPSS	British Parallel Pipe
M	Male
F	Female
X	Swivel
R	Restrictor
P	Pipe Threads (NPTF - NPSM)
J	JIC
B	O-RING BOSS

Order Online at

[www.CentralSupplyandRubber.com](http://www.CentralSupplyandRubber.com)

All Prices Are Subject To Change Without Notice.

Female IPT Swivel x Male IPT Straight

Table with 6 columns: Fem x Male, H.O.H., Cross, Airway, Couplamatic, Gates. Lists various hydraulic adapter sizes and part numbers.

Female IPT 90° Swivel x Male IPT

Table with 6 columns: Fem x Male, H.O.H., Cross, Airway, Couplamatic, Gates. Lists various hydraulic adapter sizes and part numbers.

Female IPT Swivel x Female IPT Straight

Table with 6 columns: Fem x Fem, H.O.H., Cross, Airway, Couplamatic, Gates. Lists various hydraulic adapter sizes and part numbers.

Female IPT 90° Swivel x Female IPT

Table with 6 columns: Fem x Fem, H.O.H., Cross, Airway, Couplamatic, Gates. Lists various hydraulic adapter sizes and part numbers.

Female IPT Swivel x Male ORB Straight

Table with 6 columns: Fem x Male, H.O.H., Cross, Airway, Couplamatic, Gates. Lists various hydraulic adapter sizes and part numbers.

Female IPT 90° Swivel x Male ORB

Table with 6 columns: Fem x Male, H.O.H., Cross, Airway, Couplamatic, Gates. Lists various hydraulic adapter sizes and part numbers.

Male JIC x Male IPT Straight Solid

Table with 6 columns: Male JIC x Male IPT, H.O.H., Cross, Airway, Couplamatic, Gates. Lists various hydraulic adapter sizes and part numbers.

Female JIC Swivel x Female IPT Straight

Table with 6 columns: Fem JIC x Fem IPT, H.O.H., Cross, Airway, Couplamatic, Gates. Lists various hydraulic adapter sizes and part numbers.

Female IPT Swivel to Female IPT Swivel x Male IPT (TM) or Female IPT (TF) Tee

Table with 6 columns: Fem x Fem x M or F, H.O.H., Cross, Airway, Couplamatic, Gates. Lists various hydraulic adapter sizes and part numbers.

Hydraulic Adapter Cross Reference

Female IPT x Male ORB Straight Solid

Table with 6 columns: Fem x Male, H.O.H., Cross, Airway, Couplamatic. Lists various hydraulic adapter sizes and part numbers.

Table with 6 columns: Fem x Male, H.O.H., Cross, Airway, Couplamatic. Lists various hydraulic adapter sizes and part numbers.

Female ORB x Male IPT Straight Solid

Table with 6 columns: Fem x Male, H.O.H., Cross, Airway, Couplamatic. Lists various hydraulic adapter sizes and part numbers.

Female ORB x Male ORB Straight Solid

Table with 6 columns: Fem x Male, H.O.H., Cross, Airway, Couplamatic. Lists various hydraulic adapter sizes and part numbers.

Special Adapter - Female x Female Straight Solid

Table with 6 columns: Fem x Female, H.O.H., Cross, Airway, Couplamatic. Lists various hydraulic adapter sizes and part numbers.

Hex Bushing High Pressure Hydraulic

Table with 6 columns: Male IPT x Fem IPT, H.O.H., Airway, Couplamatic. Lists various hydraulic adapter sizes and part numbers.

Special Adapters for Case

Table with 6 columns: Fem x Male, H.O.H., Cross, Airway. Lists various hydraulic adapter sizes and part numbers.

Call Toll-Free 1-800-444-8666 Or Fax (402) 341-0860



## HYDRAULIC HOSE COUPLED ASSEMBLIES WIRE BRAID - AMERICAN MADE

**Tube:** Black, oil resistant, Nitrile (NBR) **Reinforcement:** Two wire braid of high tensile steel.  
**Cover:** Black, oil & MSHA approved abrasion resistant Neoprene (CR)  
**Packaged in Cardboard Sleeves - (Working Pressure) X 4 = Bursting Pressure**

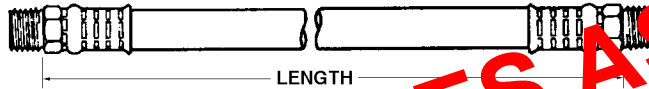

1/4"x2 Wire Braid has 1/4" solid male pipe thread couplings both ends. Working pressure 5,000# Bursting pressure 23,200#

3/8"x2 Wire Braid has 3/8" solid male pipe thread couplings both ends. Working pressure 4,800# Bursting pressure 19,200#

1/2"x 2 Wire Braid has 1/2" solid male pipe thread couplings both ends. Working pressure 4,000# Bursting pressure 16,000#

Order No.	I.D.	Length	Price
HHA-04-2-012S	1/4"	12"	\$8.29
HHA-04-2-018S	1/4"	18"	10.05
HHA-04-2-024S	1/4"	24"	11.77
HHA-04-2-030S	1/4"	30"	13.53
HHA-04-2-036S	1/4"	36"	15.29
HHA-04-2-048S	1/4"	48"	18.80
HHA-04-2-060S	1/4"	60"	22.30
HHA-04-2-072S	1/4"	72"	25.81
HHA-04-2-084S	1/4"	84"	29.31
HHA-04-2-096S	1/4"	96"	32.82
HHA-04-2-108S	1/4"	108"	36.34
HHA-04-2-120S	1/4"	120"	39.82
HHA-04-2-132S	1/4"	132"	43.34
HHA-04-2-144S	1/4"	144"	46.83

Order No.	I.D.	Length	Price
HHA-06-2-012S	3/8"	12"	\$8.87
HHA-06-2-018S	3/8"	18"	9.83
HHA-06-2-024S	3/8"	24"	11.67
HHA-06-2-030S	3/8"	30"	13.43
HHA-06-2-036S	3/8"	36"	15.24
HHA-06-2-048S	3/8"	48"	18.83
HHA-06-2-060S	3/8"	60"	22.40
HHA-06-2-072S	3/8"	72"	26.05
HHA-06-2-084S	3/8"	84"	29.62
HHA-06-2-096S	3/8"	96"	33.20
HHA-06-2-108S	3/8"	108"	36.78
HHA-06-2-120S	3/8"	120"	40.41
HHA-06-2-132S	3/8"	132"	44.00
HHA-06-2-144S	3/8"	144"	47.58

Order No.	I.D.	Length	Price
HHA-08-2-012S	1/2"	12"	\$9.96
HHA-08-2-018S	1/2"	18"	11.86
HHA-08-2-024S	1/2"	24"	13.77
HHA-08-2-030S	1/2"	30"	15.66
HHA-08-2-036S	1/2"	36"	17.50
HHA-08-2-048S	1/2"	48"	21.31
HHA-08-2-060S	1/2"	60"	25.10
HHA-08-2-072S	1/2"	72"	28.88
HHA-08-2-084S	1/2"	84"	32.64
HHA-08-2-096S	1/2"	96"	36.44
HHA-08-2-108S	1/2"	108"	40.20
HHA-08-2-120S	1/2"	120"	44.00
HHA-08-2-132S	1/2"	132"	47.77
HHA-08-2-144S	1/2"	144"	51.54

Dealer Schedule	1 to 9	10 to 24	25 Or More
(Assorted Quantities)	152	203	353

# Centralize with Central Supply

### Hyd. Suction & Return Line Hose

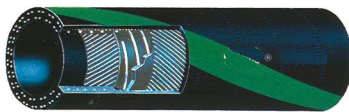

**Contains spiral wire reinforcement to prevent collapse.**  
Recommended for petroleum and water based hydraulic fluids in suction or low pressure return lines. Working temp. 200°F.

Order No.	I.D.	O.D.	Working PSI	Per Ft.
104MB-12	3/4"	1.16"	300	\$8.46
104MB-16	1"	1.48"	250	9.38
104MB-20	1-1/4"	1.77"	200	11.99
104MB-24	1-1/2"	2.05"	150	15.99

Dealer Schedule:	Less Than 50'	352
	50' Or More	104

### LOW PRESSURE HYDRAULIC RETURN LINE HOSE



High quality neoprene tube and cover reinforced with fabric braid. For return line service on hydraulic systems. This cheaper low pressure hose should be used on low pressure lines such as those between the tank and control valve and between the tank and the relief valve.

No.	Size	PSI	Per Ft.
12L2	3/4" x 2 Braid	200	\$4.35
16L2	1" x 2 Braid	200	7.05
20L2	1-1/4" x 2 Braid	200	11.70

Dealer Schedule:	Less than 50 feet	352
	50 feet or more	203

## Fax Toll-Free

# 1-800-342-7252



# Hydraulic Hose

Made in the U.S.A.



## 2 WIRE BRAID - REGULAR COVER

Recommended for high pressure hydraulic oil lines. Meets or exceeds requirements of SAE 100R2A.

Order No.	Size	O.D.	Rated PSI	Burst PSI	Full Reel	Per Ft.
HHR-06-2	3/8"	0.84"	4000	16000	350'	\$7.78
HHR-08-2	1/2"	0.95"	3500	14000	300'	8.60
Dealer Schedule:						
Less Than 150'						352
150' to Less than a Full Reel						253
Full Reel						105

# N-R-P

## Standard Thin Cover 2 Wire Braid Hydraulic Hose

Made in the U.S.A.



Recommended for high pressure hydraulic oil lines. Meets or exceeds requirements of SAE 100R2 Type AT.

Order No.	I.D.	O.D. (In.)	Rated PSI	Burst PSI	Bend Radius	UPS Reel <sup>4</sup>
HHT-04-2	1/4"	.59	5800	23200	4"	250'
HHT-06-2	3/8"	.75	4800	19200	5"	175'
HHT-08-2	1/2"	.86	4000	16000	7"	140'
HHT-12-2*	3/4"	1.16	3100	12400	9.5"	96'
HHT-16-2*	1"	1.49	2400	9600	12"	70'

<sup>4</sup>Reel consists of 2 pieces maximum, 25 foot minimum length per piece.

\*Special Order - Full Reels Only

Order No.	Description	Per Ft.
HHT-04-2	1/4"-2 wire, Thin Cover Hose	\$4.72
HHT-06-2	3/8"-2 wire, Thin Cover Hose	5.63
HHT-08-2	1/2"-2 wire, Thin Cover Hose	6.16

Dealer Schedule:		
Less Than Full Reel		203
Full UPS Reel		105

# N-R-P Hydra-Lite Hydraulic Hose

Made in the U.S.A.

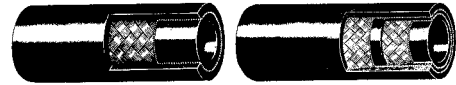

## Thin Cover - Non-Skive - Tight Bend Radius

Recommended for high pressure hydraulic oil lines. Smaller O.D. provides greater flexibility in service. **Tube:** Black, oil resistant, Nitrile (NBR). **Reinforcement:** Braids of higher tensile steel wire. **Cover:** Black, oil and abrasion resistant Neoprene (CR). MSHA accepted. **Temperature range:** -40°F to +250°F.

Order No.	I.D.	O.D. (In.)	Rated PSI	Burst PSI	Bend Radius	UPS Reel <sup>4</sup>
<b>ONE-WIRE exceeds SAE 100R1</b>						
HHH-04-1	1/4"	.53	3000	12000	2.0"	350'
HHH-06-1	3/8"	.68	3000	12000	2.5"	250'
HHH-08-1	1/2"	.80	3000	12000	3.5"	180'

<b>TWO-WIRE exceeds SAE 100R2</b>						
HHH-04-2	1/4"	.57	5800	23200	2.0"	250'
HHH-06-2	3/8"	.72	4800	19200	2.5"	200'
HHH-08-2	1/2"	.84	4000	16000	3.5"	160'
HHH-12-2*	3/4"	1.10	3100	12400	4.5"	100'

Shippable Via U.P.S. - Reel lengths are approximate.

<sup>4</sup>Reel consists of 2 pieces maximum, 25 foot minimum length per piece.

\*Carton consists of 2 pieces maximum, 25 foot minimum length per piece.

Order No.	Description	Per Ft.
HHH-04-1	1/4"-1 wire, Hydra-Lite I Hose	\$3.73
HHH-06-1	3/8"-1 wire, Hydra-Lite I Hose	4.11
HHH-08-1	1/2"-1 wire, Hydra-Lite I Hose	4.56
HHH-04-2	1/4"-2 wire, Hydra-Lite II Hose	4.46
HHH-06-2	3/8"-2 wire, Hydra-Lite II Hose	5.28
HHH-08-2	1/2"-2 wire, Hydra-Lite II Hose	5.95
HHH-12-2	3/4"-2 wire, Hydra-Lite II Hose	8.80

Dealer Schedule:		
25 ft. to Less Than Full Reel		203
Full UPS Reel		105



## Push-On Fuel Line Hose

Tube: Black, seamless oil resistant nitrile. Reinforcement: One textile spiral. Cover: Gray, oil and water resistant nitrile/PVC. Temperature range: -40°F to +200°F. **Recommended for:** Gasoline, coolants, water, oils, air, etc.

Order No.	I.D.	O.D.	PSI	Per Ft.
POH-04	1/4"	1/2"	250	\$2.80
POH-06	3/8"	5/8"	250	3.47

Dealer Schedule:		
Less Than 10'		302
10' Or More		105

Centralize *With Central*

CALL TOLL-FREE

1-800-444-8666

# MALLEABLE IRON BLACK PIPE FITTINGS

(Schedule 40 - 150 PSI Operating Pressure)

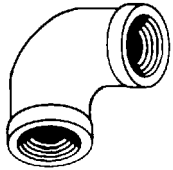

## REGULAR ELBOWS

(Both Ends Female IPT)

Order No.	Size	Degree	Price
BPER-02-45	1/8"	45	\$4.26
BPER-04-45	1/4"	45	4.35
BPER-06-45	3/8"	45	3.96
BPER-08-45	1/2"	45	3.42
BPER-12-45	3/4"	45	4.18
BPER-16-45	1"	45	5.34
BPER-20-45	1-1/4"	45	9.34
BPER-24-45	1-1/2"	45	11.53
BPER-32-45	2"	45	17.36
BPER-02-90	1/8"	90	2.95
BPER-04-90	1/4"	90	2.81
BPER-06-90	3/8"	90	2.81
BPER-08-90	1/2"	90	2.11
BPER-12-90	3/4"	90	3.05
BPER-16-90	1"	90	4.47
BPER-20-90	1-1/4"	90	7.24
BPER-24-90	1-1/2"	90	9.53
BPER-32-90	2"	90	16.35

### Regular Reducing Elbow

Order No.	Size	Degree	Price
BPERR-08-90	1/2" x 3/8"	90	\$3.84

## STREET ELBOWS

(Male to Female IPT)

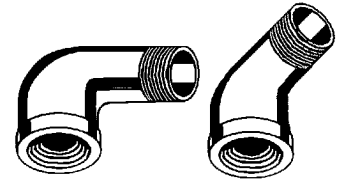

Order No.	Size	Degree	Price
BPES-02-45	1/8"	45	\$6.61
BPES-04-45	1/4"	45	4.92
BPES-06-45	3/8"	45	5.57
BPES-08-45	1/2"	45	4.49
BPES-12-45	3/4"	45	6.89
BPES-16-45	1"	45	8.00
BPES-20-45	1-1/4"	45	13.84
BPES-24-45	1-1/2"	45	17.18
BPES-32-45	2"	45	28.98
BPES-02-90	1/8"	90	4.25
BPES-04-90	1/4"	90	3.92
BPES-06-90	3/8"	90	4.25
BPES-08-90	1/2"	90	4.25
BPES-12-90	3/4"	90	5.50
BPES-16-90	1"	90	6.12
BPES-20-90	1-1/4"	90	9.34
BPES-24-90	1-1/2"	90	12.46
BPES-32-90	2"	90	20.21

### Reducing Street Elbow

Order No.	Size	Degree	Price
BPESR-08-90	1/2" F x 3/8" M	90	\$7.22

## PIPE PLUGS

Square Head

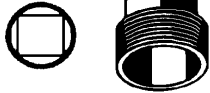

No.	Size In.	Price	No.	Size In.	Price
BPP-02	1/8	\$1.81	BPP-12	3/4	\$2.15
BPP-04	1/4	1.81	BPP-16	1	2.89
BPP-06	3/8	1.81	BPP-20	1-1/4	3.86
BPP-08	1/2	1.92	BPP-24	1-1/2	5.54
			BPP-32	2	9.40

## PIPE PLUGS

Hex Socket Head



No.	Size In.	Price
BPPS-04	1/4	\$.62
BPPS-06	3/8	.67
BPPS-08	1/2	1.15

## PIPE CAPS



No.	Size In.	Price
BPC-02	1/8	\$2.76
BPC-04	1/4	2.76
BPC-06	3/8	2.55
BPC-08	1/2	2.11
BPC-12	3/4	2.85
BPC-16	1	3.86
BPC-20	1-1/4	5.42
BPC-24	1-1/2	6.75
BPC-32	2	10.36

## HEXAGON REDUCING BUSHING



Order No.	Size	Price
BPB-04-02	1/4" x 1/8"	\$3.76
BPB-06-02	3/8" x 1/8"	3.76
BPB-06-04	3/8" x 1/4"	3.76
BPB-08-02	1/2" x 1/8"	3.76
BPB-08-04	1/2" x 1/4"	3.76
BPB-08-06	1/2" x 3/8"	3.76
BPB-12-02	3/4" x 1/8"	3.68
BPB-12-04	3/4" x 1/4"	3.64
BPB-12-06	3/4" x 3/8"	3.68
BPB-12-08	3/4" x 1/2"	3.40
BPB-16-02	1" x 1/8"	3.93
BPB-16-04	1" x 1/4"	4.21
BPB-16-06	1" x 3/8"	4.68
BPB-16-08	1" x 1/2"	3.50
BPB-16-12	1" x 3/4"	3.50
BPB-20-08	1-1/4" x 1/2"	5.95
BPB-20-12	1-1/4" x 3/4"	5.95
BPB-20-16	1-1/4" x 1"	5.95
BPB-24-08	1-1/2" x 1/2"	8.21
BPB-24-12	1-1/2" x 3/4"	8.21
BPB-24-16	1-1/2" x 1"	8.21
BPB-24-20	1-1/2" x 1-1/4"	8.21
BPB-32-16	2" x 1"	10.65
BPB-32-20	2" x 1-1/4"	10.65
BPB-32-24	2" x 1-1/2"	10.65

## STRAIGHT PIPE TEE

(All Ends Female IPT)

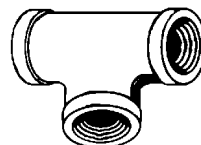

No.	Size In.	Price	No.	Size In.	Price
BPT-02	1/8	\$4.49	BPT-12	3/4	\$4.64
BPT-04	1/4	4.24	BPT-16	1	6.85
BPT-06	3/8	4.24	BPT-20	1-1/4	11.12
BPT-08	1/2	2.74	BPT-24	1-1/2	13.84
			BPT-32	2	23.53

DEALER SCHEDULE THIS PAGE.....304

Galvanized fittings - Call for price & availability.

# MALLEABLE IRON BLACK PIPE FITTINGS

(Schedule 40 - 150 PSI Operating Pressure)

## BLACK PIPE NIPPLES



Order No.	Size	Price	Order No.	Size	Price	Order No.	Size	Price	Order No.	Size	Price
BPN-02-000	1/8"xClose	\$1.33	BPN-06-200	3/8"x2"	\$1.87	BPN-12-200	3/4"x2"	\$1.70	BPN-20-308	1-1/4"x3-1/2"	\$4.16
BPN-02-108	1/8"x1-1/2"	1.64	BPN-06-208	3/8"x2-1/2"	2.39	BPN-12-208	3/4"x2-1/2"	1.93	BPN-20-400	1-1/4"x4"	4.16
BPN-02-200	1/8"x2"	1.64	BPN-06-300	3/8"x3"	2.39	BPN-12-300	3/4"x3"	1.93	BPN-20-500	1-1/4"x5"	4.98
BPN-02-208	1/8"x2-1/2"	1.90	BPN-06-308	3/8"x3-1/2"	2.81	BPN-12-308	3/4"x3-1/2"	2.39	BPN-20-600	1-1/4"x6"	5.91
BPN-02-300	1/8"x3"	1.90	BPN-06-400	3/8"x4"	2.81	BPN-12-400	3/4"x4"	2.39	BPN-24-000	1-1/2"xClose	3.63
BPN-02-308	1/8"x3-1/2"	2.31	BPN-06-500	3/8"x5"	4.06	BPN-12-500	3/4"x5"	3.00	BPN-24-200	1-1/2"x2"	3.92
BPN-02-400	1/8"x4"	2.31	BPN-06-600	3/8"x6"	4.51	BPN-12-600	3/4"x6"	3.39	BPN-24-208	1-1/2"x2-1/2"	4.38
BPN-02-500	1/8"x5"	4.38	BPN-08-000	1/2"xClose	1.39	BPN-12-900	3/4"x9"	5.80	BPN-24-300	1-1/2"x3"	4.38
BPN-02-600	1/8"x6"	4.80	BPN-08-108	1/2"x1-1/2"	1.39	BPN-16-000	1"xClose	2.31	BPN-24-308	1-1/2"x3-1/2"	4.91
BPN-04-000	1/4"xClose	1.60	BPN-08-200	1/2"x2"	1.39	BPN-16-200	1"x2"	2.52	BPN-24-400	1-1/2"x4"	4.91
BPN-04-108	1/4"x1-1/2"	1.70	BPN-08-208	1/2"x2-1/2"	1.64	BPN-16-208	1"x2-1/2"	2.66	BPN-24-500	1-1/2"x5"	6.00
BPN-04-200	1/4"x2"	1.70	BPN-08-300	1/2"x3"	1.64	BPN-16-300	1"x3"	2.66	BPN-24-600	1-1/2"x6"	6.88
BPN-04-208	1/4"x2-1/2"	2.19	BPN-08-308	1/2"x3-1/2"	1.97	BPN-16-308	1"x3-1/2"	3.31	BPN-32-000	2"xClose	4.96
BPN-04-300	1/4"x3"	2.19	BPN-08-400	1/2"x4"	1.97	BPN-16-400	1"x4"	3.31	BPN-32-208	2"x2-1/2"	5.69
BPN-04-308	1/4"x3-1/2"	2.53	BPN-08-408	1/2"x4-1/2"	2.31	BPN-16-500	1"x5"	3.93	BPN-32-300	2"x3"	5.69
BPN-04-400	1/4"x4"	2.53	BPN-08-500	1/2"x5"	2.58	BPN-16-600	1"x6"	4.64	BPN-32-308	2"x3-1/2"	6.86
BPN-04-500	1/4"x5"	3.86	BPN-08-508	1/2"x5-1/2"	2.58	BPN-20-000	1-1/4"xClose	2.92	BPN-32-400	2"x4"	6.86
BPN-04-600	1/4"x6"	4.55	BPN-08-600	1/2"x6"	2.58	BPN-20-200	1-1/4"x2"	3.30	BPN-32-500	2"x5"	7.93
BPN-06-000	3/8"xClose	1.64	BPN-12-000	3/4"xClose	1.58	BPN-20-208	1-1/4"x2-1/2"	3.51	BPN-32-600	2"x6"	9.26
BPN-06-108	3/8"x1-1/2"	1.87	BPN-12-108	3/4"x1-1/2"	1.70	BPN-20-300	1-1/4"x3"	3.51	BPN-48-000	3"xClose	20.42



## Malleable Iron Unions

150 lbs. Steam Working Pressure  
300 lbs. Cold Water, Oil, Gas, Gasoline  
Non-Stock Working Pressure  
Female Ground Joint

No.	Size In.	Price
BPU-02	1/8	\$14.15
BPU-04	1/4	13.65
BPU-06	3/8	12.02
BPU-08	1/2	11.95
BPU-12	3/4	15.23
BPU-16	1	17.90
BPU-20	1-1/4	23.84
BPU-24	1-1/2	31.83
BPU-32	2	55.62



## REDUCING COUPLINGS

Order No.	Size	Price
BPCR-04-02	1/4" x 1/8"	\$3.40
BPCR-06-02	3/8" x 1/8"	3.40
BPCR-06-04	3/8" x 1/4"	3.40
BPCR-08-04	1/2" x 1/4"	3.11
BPCR-08-06	1/2" x 3/8"	2.93
BPCR-12-08	3/4" x 1/2"	3.37
BPCR-16-12	1" x 3/4"	5.22
BPCR-20-16	1-1/4" x 1"	6.52
BPCR-24-20	1-1/2" x 1-1/4"	8.23
BPCR-32-24	2" x 1-1/2"	11.97

## "STEEL" STRAIGHT COUPLINGS



No.	Size In.	Price
BSCS-02	1/8	\$1.85
BSCS-04	1/4	2.55
BSCS-06	3/8	3.07
BSCS-08	1/2	3.27
BSCS-12	3/4	4.17
BSCS-16	1	5.82
BSCS-20	1-1/4	7.44
BSCS-24	1-1/2	9.42
BSCS-32	2	13.51
BSCS-48	3	53.98
BSCS-64	4	95.68

DEALER SCHEDULE (Pipe Fittings).....304

## Central TEptape

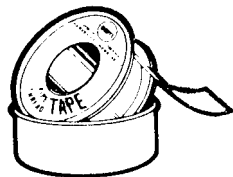

Seals efficiently at high and low temperatures. Temperature range 400 to 500 F. degrees. Self lubricating and compressible. Will not harden. Prevents galling, seizing and corrosion. Permits frequent disassembly, if necessary. Leakproof joints. Clean low cost way to eliminate leakage problems, need for expensive flanged fittings. 100% sealing and positive protection for all types of threaded joints.

No.	Price
5026-D	1/2" x 260" (In Plastic Dispenser) ..... \$ .97

Dealer Schedule: 10 Or More ..... 23/133  
Less Than 10 ..... 152



## Slic-Tite Thread Paste

Recommended for: Gasoline, Kerosene, LP Gases, Oil, Refrigerants, Solvents, Caustics, Acids, Gas, Water, Steam & Air.  
DO NOT USE FOR OXYGEN SYSTEMS

Order No.	Price
LC-42009	1/4 Pint can with Brush ..... \$13.20

## PIPETITE-STIK



Use on metal threads. For water, steam, air, and natural gas service. Sealing temp. up to 350°F. Pressures to 2000 PSI - liquid, 350 PSI - gas. Non-toxic, lead-free.

NOT FOR OXYGEN SERVICE, CHLORINE OR OTHER OXIDIZERS.

Order No.	Price
LC-11175	Pipetite-Stik Thread Sealant ..... \$1.78

Dealer Schedule.....152

# Disc Harrow Bearing Cross Reference

## CYLINDRICAL

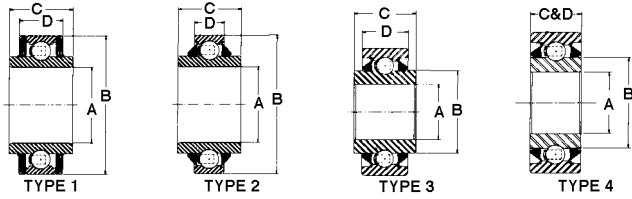

## SPHERICAL

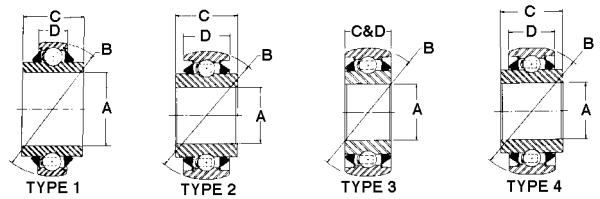

### CYLINDRICAL --- ROUND BORE

Bore	BCA	Fafnir	Federal	Link Belt	NDH	Lubrication
1-1/2"	DC208TT10	W208PP8				Prelubricated
1.9402"	DC210TTR9	GW210PP9				Relubricatable

### CYLINDRICAL --- SQUARE BORE

Bore	BCA	Fafnir	Federal	Link Belt	NDH	Lubrication
1-1/8"	DC208TT	W208K E9003	TN208S1A		AS4508B	Prelubricated
1-1/8"	DC208TT5	W208PP5	TN208S1	W208PP5	AS4508BH	Prelubricated
1-1/8"	DC208TT8	W208PP8	T208S1	W208PP8	AS4508BD	Prelubricated
1-1/8"	DC208TTR17	GW208PP17				Relubricatable
1-1/8"	DC210TTR4	GW210PP4		GW210PP4	RAS4510B	Relubricatable
1-1/2"	DC211TT3	W211PP3	TW211S4	W211PP3	AS4511BD	Prelubricated
1-1/2"	DC211TTR3	GW211PP3		GW211PP3	RAS4511BD	Relubricatable
1-1/2"	DC211TT5	W211PP5	T211S4A		AS4511AE	Prelubricated

### SPHERICAL --- ROUND BORE

Bore	BCA	Fafnir	Federal	Link Belt	NDH	Lubrication
1-1/2"	DS208TT2A	W208PPB23	TS208H	W208PPB23		Prelubricated
1-3/16"	DS208TT7	W208PPB7	TN208A	W208PPB7		Prelubricated
45mm	DS209TT2	W209PPB2	TWS209	W209PPB2	AS4509BE	Prelubricated
45mm	DS209TTR2	GW209PPB2		GW209PPB2	RAS4509BE	Relubricatable
1-1/2"	DS209TT4	W209PPB4	TWS209A	W209PPB4	AS4509BD	Prelubricated
1-1/2"	DS209TTR4	GW209PPB4	TWS209AR	GW209PPB4	RAS4509BD	Relubricatable
1-1/2"	DS209TT6	W209PPB6			AS4509B	Prelubricated
1-3/4"	DS209TTR10	GW209PPB11				Relubricatable
1-3/4"	DS210TT5	W210PPB5	TWS210A	W210PPB5	AS4510D	Prelubricated
1-3/4"	DS210TTR5R	GW210PPB5		GW210PPB5		Relubricatable
1-15/16"	DS210TT2	W210PPB2	TWS210B	W210PPB2		Prelubricated
1-15/16"	DS210TTR2	GW210PPB2	TWS210BR	GW210PPB2		Relubricatable
2-3/16"	DS211TT2	W211PPB2	TWS211A	W211PPB2		Prelubricated
2-3/16"	DS211TTR2	GW211PPB2		GW211PPB2		Relubricatable
2-3/16"	DS211TTR8R	GW211PPB8				Relubricatable
1.785"	DS211TTR13	GW211PPB13				Relubricatable
1-3/4"	FD209RA	(IHC No. ST491A**) Round IHC Special				

\*\*NOTE .... ST491A Bearing is a replacement for IHC Disc Harrow Models 130, 150, 330, 340, 350, 370, 470, 475, 480, 490 & 760

### SPHERICAL --- SQUARE BORE

Bore	BCA	Fafnir	Federal	Link Belt	NDH	Lubrication
1-1/8"	DS208TT5	W208PPB5	TNS208S1	W208PPB5	AS4508BJ	Prelubricated
1-1/8"	DS208TTR5	GW208PPB5	TNS208S1R	GW208PPB5	RAS4508J	Relubricatable
1"	DS208TT6	W208PPB6	TNS208S	W208PPB6	AS4508BK	Prelubricated
1"	DS208TTR6	GW208PPB6		GW208PPB6	RAS4508AE	Relubricatable
1-1/8"	DS208TT8	W208PPB8		W208PPB8		Prelubricated
1-1/8"	DS208TTR8	GW208PPB8	TS208S1R	GW208PPB8	RAS4508EF	Relubricatable
1"	DS208TT9	W208PPB9		W208PPB9		Prelubricated
7/8"	DS208TT11	W208PPB11		W208PPB11		Prelubricated
1-1/8"	DS208TT12	W208PPB12		W208PPB12		Prelubricated
1-1/4"	DS209TT5	W209PPB5	TS209S2	W209PPB5	AS4509A	Prelubricated
1-1/4"	DS209TTR5	GW209PPB5		GW209PPB5		Relubricatable
1-1/4"	DS209TT7	W209PPB7	TSC209S2A	W209PPB7	AS4509AC	Prelubricated
1-1/4"	DS209TTR8	GW209PPB8		GW209PPB8		Relubricatable
1-1/8"	DS210TT4	W210PPB4	TWS210S1	W210PPB4		Prelubricated
1-1/8"	DS210TTR4	GW210PPB4		GW210PPB4	RAS4510F	Relubricatable
1-1/8"	DS210TTR5S					Relubricatable
1-1/2"	DS211TT3	W211PPB3	TWS211S4	W211PPB3	AS4511BE	Prelubricated
1-1/2"	DS211TTR3	GW211PPB3	TWS211S4R	GW211PPB3	RAS4511BE	Relubricatable
1-1/2"	DS211TT6	W211PPB6	TSC211S4A		AS4511AC	Prelubricated

# Disc Bearings

## CYLINDRICAL

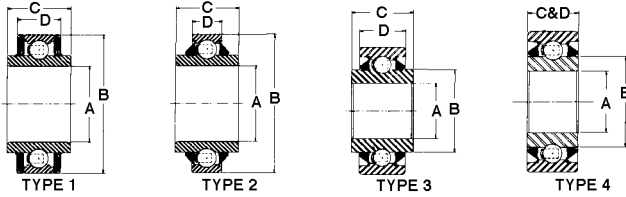

## SPHERICAL

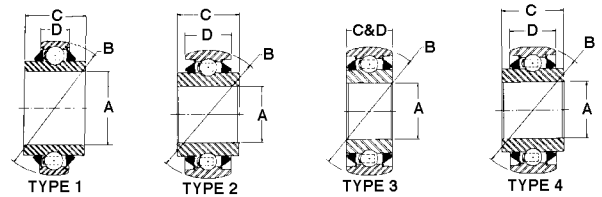

### CYLINDRICAL --- ROUND BORE

Bore (A)	Pre-Lube No.	Re-Lube No.	Type	B	C	D	Price
1-1/2"	DC208TT10		2	3.5433	1.6875	0.8268	\$27.64
1.9402"		DC210TTR9	2	3.5433	1.4380	0.9060	55.05

### CYLINDRICAL --- SQUARE BORE

Bore (A)	Pre-Lube No.	Re-Lube No.	Type	B	C	D	Price
1-1/8"	DC208TT		1	3.1496	1.6875	1.2790	\$55.45
1-1/8"	DC208TT5		2	3.1496	1.4375	0.7087	30.30
1-1/8"	DC208TT8		3	3.1496	1.4375	1.1875	41.36
1-1/8"		DC208TTR17	3	3.3750	1.4375	1.1875	49.90
1-1/8"		DC210TTR4	4	3.5433	1.1875	1.1875	75.45
1-1/2"	DC211TT3		4	3.9370	1.3125	1.3125	51.67
1-1/2"		DC211TTR3	4	3.9370	1.3125	1.3125	65.50
1-1/2"		DC211TTR3E	3	3.9370	1.7500	1.3125	57.00
1-1/2"	DC211TT5		3	4.0000	1.7500	1.4380	57.40

### SPHERICAL --- ROUND BORE

Bore (A)	Pre-Lube No.	Re-Lube No.	Type	B	Flange Series	C	D	Price
1-1/2"	DS208TT2A		1	3.1500	80	1.6880	1.1188	\$58.75
1-3/16"	DS208TT7		1	3.1496	80	1.1875	0.7087	37.60
45mm	DS209TT2		3	3.3465	85	1.1875	1.1875	42.10
45mm		DS209TTR2	3	3.3465	85	1.1875	1.1875	45.04
1-1/2"	DS209TT4		3	3.3465	85	1.1875	1.1875	40.90
1-1/2"		DS209TTR4	3	3.3465	85	1.1875	1.1875	53.50
1-1/2"	DS209TT6		4	3.4380	87	1.1875	1.1875	46.15
1-3/4"		DS209TTR10	1	3.3465	85	1.4375	0.8661	45.80
1-3/4"	DS210TT5		3	3.5430	90	1.1880	1.1880	56.00
1-3/4"		DS210TTR5R	2	3.5430	90	1.1880	1.1880	84.25
1-15/16"	DS210TT2		3	3.5433	90	1.1875	1.1875	44.45
1-15/16"		DS210TTR2	3	3.5433	90	1.1875	1.1875	50.15
2-3/16"	DS211TT2		3	3.9370	100	1.3125	1.3125	55.00
2-3/16"		DS211TTR2	3	3.9370	100	1.3125	1.3125	58.55
2-3/16"		DS211TTR8R	1	3.9370	100	1.3125	0.9843	85.20
2.195"		DS211TTR9	1	3.9370	100	1.5625	0.9843	50.27
1.785"		DS211TTR13	3	3.9370	100	1.1875	1.1875	82.65

### IHC SPECIAL

1-3/4"	FD209RA	(IHC #ST491A**) Round						42.90
--------	---------	-----------------------	--	--	--	--	--	-------

\*\*NOTE - ST491A Bearing is a replacement for IHC Disc Models 130, 150, 330, 340, 350, 370, 470, 475, 480, 490 & 760.

### SPHERICAL --- SQUARE BORE

Bore (A)	Pre-Lube No.	Re-Lube No.	Type	B	Flange Series	C	D	Price
1-1/8"	DS208TT5		1	3.1496	80	1.4375	0.7087	\$32.63
1-1/8"		DS208TTR5	2	3.1496	80	1.4375	0.9449	53.25
1"	DS208TT6		1	3.1496	80	1.4375	0.7087	35.45
1"		DS208TTR6	2	3.1496	80	1.4375	0.9449	57.10
1-1/8"	DS208TT8		2	3.1496	80	1.4375	1.1875	36.10
1-1/8"		DS208TTR8	2	3.1496	80	1.4375	1.1875	44.10
1"	DS208TT9		2	3.1496	80	1.4375	1.1875	35.70
7/8"	DS208TT11		4	3.4380	87	1.4375	1.1875	47.70
1-1/8"	DS208TT12		4	3.4343	87	1.4375	1.1880	42.00
1-1/4"	DS209TT5		2	3.3465	85	1.4375	1.1875	44.15
1-1/4"		DS209TTR5	2	3.3465	85	1.4375	1.1875	62.55
1-1/4"	DS209TT7		4	3.4380	87	1.4375	1.1875	73.35
1-1/4"		DS209TTR8	1	3.3465	85	1.4375	0.8661	46.90
1-1/8"	DS210TT4		3	3.5433	90	1.1875	1.1875	63.40
1-1/8"		DS210TTR4	3	3.5433	90	1.1875	1.1875	81.85
1-1/8"		DS210TTR5S	2	3.5433	90	1.7500	1.1875	103.95
1-1/2"	DS211TT3		3	3.9370	100	1.3125	1.3125	51.22
1-1/2"		DS211TTR3	3	3.9470	100	1.3125	1.3125	62.30
1-1/2"	DS211TT6		4	4.1250		1.7500	1.4375	90.65

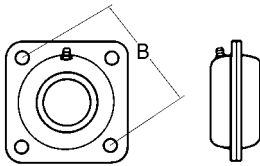

### Disc Harrow Bearings

4-BOLT FLANGED

I.H.C.

Order No.	OEM No.	Shaft Size	B	Price
FD209RA .....	ST491A .....	1.77 (1-3/4)"	5"	\$42.90
FD209RB .....	ST3027 .....	1.53	5"	42.90
FD211RB .....	ST740B .....	2.1875	5.5"	95.02
FD211RE .....	ST3028 .....	1.78	5.5"	64.80
FD211RJA .....	ST3012A .....	1.9380	5.5"	125.85

**DO NOT come with Lock Collars.**



### Disc Harrow Square Bore Tapered Roller Bearings

Order No.	Description	Shaft	Price
<b>John Deere</b>			
4T-LM501334SD ..	Dbl. Row #JD8949 .....	1.25"	84.12
4T-LM501310 .....	Cup (2 required) .....		7.66
<b>Case/IH - Kewanee</b>			
4T-13678SD .....	Dbl. Row #469834R91 ..	1.156"	74.35
4T-13620 .....	Cup (2 required) .....		13.50

**Popular Kit For The Above**

DK-3 ....	Includes: 1-385SD, 2-382A, 2-200392 Seals (JD #AB14028) .....		155.30
-----------	---	--	--------

Dealer Schedule.....152

All Prices Are Subject To Change Without Notice

### Square Bore Disc Harrow Bearings

4-BOLT FLANGED



Order No.	Shaft Size	Bolt Circle	Thru	Price
FD208R1 .....	1.00 (1")	4.69"		\$51.15
FD209RK .....	1.25 (1-1/4")	5"	1.6845"	78.08
FD211RM .....	1.50 (1-1/2")	5-1/2"	2"	125.45

**DO NOT come with Lock Collars.**

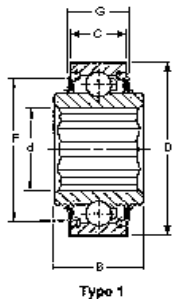

Type 1

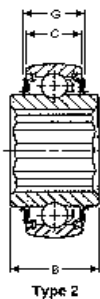

Type 2

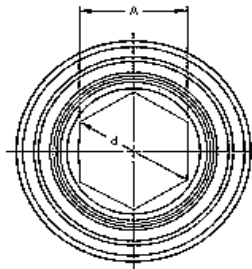

## HEX BORE Bearings

TYPE 2 - SPHERICAL - RE-GREASEABLE

TYPE 2 - SPHERICAL - PRELUBRICATED

Order No.	Fafnir No.	A Shaft	O.D.	Flange Series	Price
HPS014-GP .....	205KRRB2 .....	7/8"	2.0472	52	\$29.00
HPS100-GP .....	206KRRB6 .....	1"	2.4409	62	23.13
HPS100-TPD* .....	206KRR6 .....	1"	2.4409	62	31.25
HPS102-GPE .....	207KRRB12 .....	1-1/8"	2.8346	72	38.40
HPS103-GP3 .....	207KRRB17 .....	1-1/4"	2.8346	72	38.10
HPS103-TP2 .....	207KPPB3 .....				
	207PPB5 .....	1-1/4"	2.8346	72	39.30
HPS106-GP .....	W208KRRB6 .....	1-3/8"	3.1496	80	40.10
HPS108-GPB .....	210RRB6 .....	1-1/2"	3.5430	90	54.50

Order No.	Fafnir No.	A Shaft	O.D.	Flange Series	Price
HPS104-TR* .....	GW208PPB22 .....	1-1/4"	3.1496	80	\$54.00

TYPE 1 - CYLINDRICAL - PRELUBRICATED

Order No.	Fafnir No.	A Shaft	O.D.	Price
HPC014-GP .....	205KRR2 .....	7/8"	2.0472	24.23
HPC100-GP .....	206KRR6 .....	1"	2.4409	24.23
HPC100-TPD* .....	206KPP3 .....	1"	2.4409	29.30
HPC104-TPA .....	W208PP21 .....	1-1/4"	3.1496	33.13

\* Triple Lip Seal

### SPECIAL BEARINGS - SPHERICAL O.D. - DOUBLE SEALED

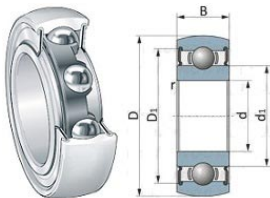

Order No.	Fafnir No.	(D) O.D.	(d) I.D.	(B) Width	Price
S202-FF .....	202NPPB .....	1.3750	0.5906	0.4331	\$16.70
S203-FF .....	203NPPB .....	1.5748	0.6693	0.4724	24.45
S204-FF .....	204NPPB, 204PPB .....	1.8504	0.7874	0.5512	29.70
S205-FF .....	205NPPB .....	2.0472	0.9843	0.5906	23.60
S206-FF .....	206NPPB .....	2.4409	1.1811	0.6299	29.00
S207-FF .....	207NPPB, 207PPB .....	2.8346	1.3780	0.6693	51.45
S208-FF .....	208NPPB .....	3.1496	1.5748	0.7087	47.95
S305-FF .....	305NPPB .....	2.4409	0.9843	0.6693	48.92

DEALER SCHEDULE THIS PAGE.....152

## SPECIAL BALL BEARINGS (WITHOUT COLLARS)

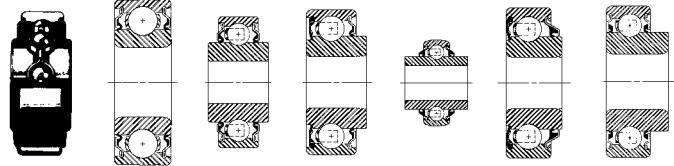

All Types NOT Pictured

Order No.	Other Manufacturer & Number	I.D.	O.D.	Inner Ring Width	Price
202FFLB**	New Departure 499502H, Z499502AC	0.6250	1.3750	0.4331	\$15.44
203jd	Fafnir 203KYP2	0.6690	1.5740	0.550	8.85
203RRAR10	Fafnir 203KRR2, BB203KRR2	0.6400	1.5748	0.7200	9.10
203RRAR10N2	Fafnir BB203KRR2	0.6400	1.5748	0.7200	14.10
203RRH10	Fafnir 203KRR6	0.6400	1.8504	0.7200	25.90
204BBAR	Fafnir 204KRNP2, 204KR3, 204KRNP3, 204RR6, P204RR6, P204KRNP2	0.7505	1.7805	0.6100	10.60
204BBE	Fafnir 204RR8	0.6260	1.7805	0.6100	17.90
204FGB	Fafnir 204KRRD4 (Tye-Grain Drill)	0.6290	1.8504	0.6860	26.20
204FREN	Fafnir H204KYNP2	0.6320	1.7805	0.7350	18.00
204FVMN	Fafnir 204RY2	0.6310	1.7800	0.7300	16.85
204GGB*	Fafnir 1012KRRB3	0.7515	1.8504	1.3440	19.51
205RHN	Fafnir 205KP3, 205P5, 205KR3	0.7510	2.0472	0.7000	21.85
205RRAN	Fafnir P205NPP4	0.7500	2.0472	0.5906	26.11
205RVA	Fafnir 205KRP2	0.7510	2.0472	0.8280	19.75
205TTH	Fafnir 205PPB7	0.9425	2.0472	1.3750	17.40
206GGB*	Fafnir 206KLLB3, 206KRRB3	1.1258	2.4409	0.9449	25.00
206GGH	New Departure D88506BB	0.7580	2.4409	0.9449	32.80
88107-BVV	Fafnir 207KYY	1.3780	2.8346	0.9843	32.30
88503	Fafnir 203KLL, 203KLL2, 203NPP8	0.6693	1.5748	0.6390	31.25

\* Spherical O.D.

\*\* With Snap Ring

Dealer Schedule.....152

**MANY OTHER BEARINGS ARE AVAILABLE...CALL FOR PRICES!**

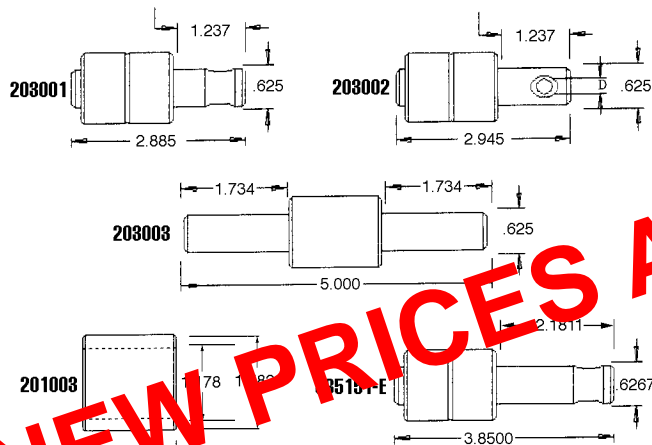

### GAUGE WHEEL / WATER PUMP BEARINGS

No.	Description	Price
203001	(885154B) Water Pump Bearing with under-cut shaft. For A.C., J.D, MF, Nobel and Spring Devil	\$18.93
203002	(1B0732RSP) Water Pump Bearing with Cross-Hole. For J.D. & Kinze	20.52
201003	Powdered Metal Sleeve for 4x16 gage wheel, fits 203001 & 203002 Brgs.	2.88
203003	(885151B0S2) Water Pump Bearing with Double End Shaft. for Noble H.D. and Lilliston	20.08
885151-E	IHC #526769R91 Water Pump Brg. with Long Shaft	20.52

Dealer Schedule.....152

*Centralize your purchasing with Central Supply & Rubber Co.*

# BCA BALL BEARINGS

**SELF-ALIGNING WITH COLLARS - EXTENDED INNER RING ONE SIDE ONLY**  
**SPHERICAL - ECCENTRIC CAM LOCKING - NON-RELUBRICATABLE**

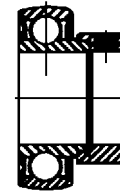

Order No.	Shaft Size	O.D.	Fafnir No.	Flange Series	Price
NPS014-RPC	7/8"	2.0472"	RA014RRB	52	\$15.30
NPS101-RPC	1-1/16"	2.4409"	RA101RRB	62	19.65
NPS107-RPC	1-7/16"	2.8346"	RA107RRB	72	32.40

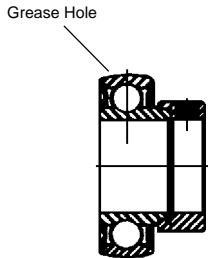

# BCA BALL BEARINGS

**SELF-ALIGNING WITH COLLARS - EXTENDED INNER RING ONE SIDE ONLY**  
**SPHERICAL - - - ECCENTRIC CAM LOCKING**  
**RELUBRICATABLE (With Grease Hole On Back Side Of Outer Race)**

Order No.	Shaft Size	Fafnir No.	Flange Series	O.D.	Price
NPS008-RRC	1/2"	GRA008RRB	40	1.574	\$22.20
NPS010-RRC	5/8"	GRA010RRB	40	1.574	17.10

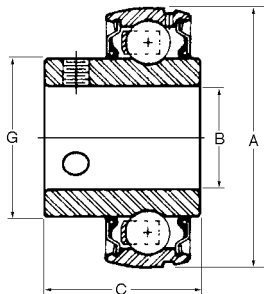

# BCA BALL BEARINGS

**SELF-ALIGNING WITH SET SCREW LOCKING COLLAR**  
**SPHERICAL - - - EXTENDED INNER RING ONE SIDE ONLY**  
**RELUBRICATABLE (With Grease Hole On Back Side Of Outer Race)**

Order/BCA No.	Shaft Size (B)	Fafnir No.	O.D. (A)	(C)	(G)	Flange Series	Price
SNPS014-RR	7/8"	GYA014RRB	2.047	1.1090	1.331	52	\$24.90
SNPS103-RR	1-3/16"	GYA103RRB	2.440	1.2810	1.589	62	27.30



**ECCENTRIC LOCKING COLLARS**  
**(For Bearing Inserts)**

Order No.	Shaft Size	Fafnir No.	Price
C008	1/2"	S1008K	\$5.90
C015	15/16"	S1015K	5.22
C101	1-1/16"	S1101K	6.00
C103	1-3/16"	S1103K	6.50
C107	1-7/16"	S1107K	8.15
C114	1-7/8"	S1114K	12.53
C115	1-15/16"	S1115K	19.10

**We Ship Over 95%**  
**Of Our Orders**  
**The Same Day!**



## BCA BALL BEARINGS

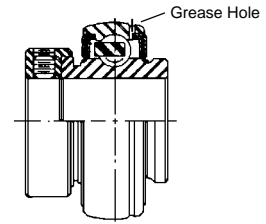

**SPHERICAL --- ECCENTRIC CAM LOCKING --- WIDE INNER RING  
RELUBRICATABLE (With Grease Hole On Back Side Of Outer Race)**

Order No.	Shaft Size	Fafnir No.	Flange Series	O.D.	Price
WPS015-GRC .....	15/16" .....	G1015KRRB .....	52 .....	2.047 .....	\$27.35
WPS102-GRC .....	1-1/8" .....	G1102KRRB .....	62 .....	2.440 .....	46.50
WPS110-GRC .....	1-5/8" .....	G1110KRRB .....	85 .....	3.346 .....	65.57
WPS111-GRC .....	1-11/16" .....	G1111KRRB .....	85 .....	3.346 .....	71.90
WPS114-GRC .....	1-7/8" .....	G1114KRRB .....	90 .....	3.543 .....	90.10
WPS203-GRC .....	2-3/16" .....	G1203KRRB .....	100 .....	3.937 .....	104.10

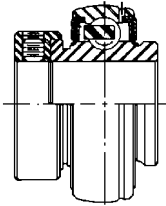

## BCA BALL BEARINGS

**SPHERICAL O.D. --- ECCENTRIC CAM LOCKING --- WIDE INNER RING  
NON-RELUBRICATABLE**

Order No.	Shaft Size	Fafnir No.	Flange Series	O.D.	Price
WPS100-GPC .....	1" .....	1100KRRB .....	52 .....	2.047 .....	\$26.00
WPS103-GP2C .....	1-1/4" sm. ....	1103KRRB2 .....	62 .....	2.440 .....	45.50
WPS108-GPC .....	1-1/2" .....	1108KRRB .....	80 .....	3.149 .....	52.10

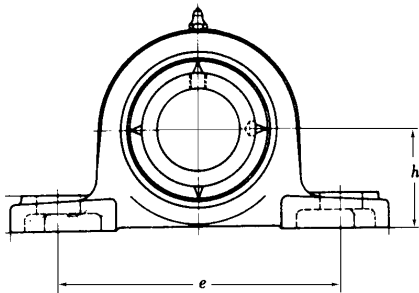

## CAST IRON PILLOW BLOCK & BEARING UNITS

**ECCENTRIC LOCKING COLLAR TYPE  
TWO BOLT - LOW CENTER SHAFT HEIGHT  
SPHERICAL - REGREASEABLE**

Order No.	Shaft Size	BCA No.	(h) Shaft Height	(e) Bolt Spacing (C-C)	Price
UELPL206-102T .....	1-1/8" .....	PWG-1-1/8R .....	1-9/16" .....	4-3/4" .....	\$71.35
UELPL207-104T .....	1-1/4" std .....	PWG-1-1/4R .....	1-13/16" .....	5" .....	76.55
UELPL207-107T .....	1-7/16" .....	PWG-1-7/16R .....	1-13/16" .....	5" .....	76.55
UELPL210-115T .....	1-15/16" .....	PWG-1-15/16R .....	2-3/16" .....	6-1/4" .....	114.20

DEALER SCHEDULE THIS PAGE.....152

***Ordering has never been easier!***  
**On-Line: [www.centernalsupplyandrubber.com](http://www.centernalsupplyandrubber.com)**  
**Via Phone: 1-800-444-8666**  
**Via Fax: (402) 341-0860**

# Central BRONZE BEARING ASSORTMENT

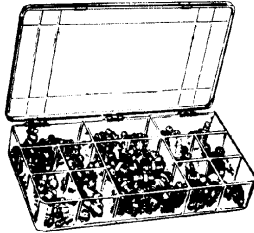

45 Bronze Bearings in 12 of the most popular sizes. Packaged in a see-through utility box, made of tough polypropylene with double hinges and positive latches. Box size: 14"x9"x2". Contains: 4 Ea. P165-08, P180-08, P200-08, P210-08, P220-08, P230-08, P235-12, P245-08, P245-12. 3 EA. P275-12, P285-08, P285-12.

No.	Description	List
P400-45	..... Bronze Bearing Assortment .....	\$103.62
	..... Dealer Schedule.....152	

*Centralize With Central*

# Central POROUS BRONZE BEARINGS

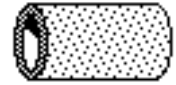

No.	I.D.	O.D.	Lgth.	List
P165-08*	1/2"	5/8"	1"	\$1.18
P175-08	1/2"	3/4"	1"	1.50
P180-08*	5/8"	3/4"	1"	1.30
P200-08*	3/4"	7/8"	1"	1.07
P210-08*	3/4"	1"	1"	1.90
P210-16	3/4"	1"	2"	2.03
P220-08*	7/8"	1"	1"	1.36
P230-08*	7/8"	1-1/8"	1"	2.71
P230-12	7/8"	1-1/8"	1-1/2"	2.96
P235-08	1"	1-1/8"	1"	1.79
P235-12*	1"	1-1/8"	1-1/2"	1.89
P245-08*	1"	1-1/4"	1"	2.12
P245-12*	1"	1-1/4"	1-1/2"	3.29
P245-16	1"	1-1/4"	2"	3.55
P275-12*	1-1/8"	1-3/8"	1-1/2"	3.25
P285-08*	1-1/4"	1-1/2"	1"	2.50
P285-12*	1-1/4"	1-1/2"	1-1/2"	3.20
P295-12	1-3/8"	1-5/8"	1-1/2"	4.25
P300-16	1-1/2"	1-3/4"	2"	4.60
P310-12	1-3/4"	2"	1-1/2"	5.62
P330-16	2"	2-1/4"	2"	5.73

\* Denotes Sizes In Assortment

Dealer Schedule.....152

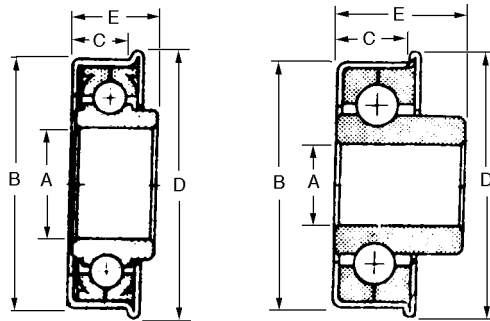

Type F Shielded  
Type SF Shielded & Sealed  
Type 150 Shielded

Type ESF Shielded & Sealed  
w/Extended Locking Collar

Single row radial and thrust w/flanged case.

Shielded and grease packed with or without neoprene seals.

Dye bearings come with built in lip or flange.

Some of the uses are augers, elevators, feeders, etc.

**Call Toll-Free  
1-800-444-8666**

# DON DYE BEARINGS

Order No.	A	B	C	D	E	List
F-12112	1/2"	1-1/2"	9/64"	1-19/32"	17/32"	\$7.91
F-58112	5/8"	1-1/2"	9/64"	1-19/32"	17/32"	7.91
F-12-32	3/4"	2"	7/16"	2-1/8"	41/64"	7.25
SF-12-32	3/4"	2"	7/16"	2-1/8"	41/64"	7.65
ESF-12-32	3/4"	2"	7/16"	2-1/8"	1-1/4"	9.95
F-14-32	7/8"	2"	7/16"	2-1/8"	41/64"	7.25
SF-14-32	7/8"	2"	7/16"	2-1/8"	41/64"	7.65
ESF-14-32	7/8"	2"	7/16"	2-1/8"	1-1/4"	9.95
F-16-32	1"	2"	7/16"	2-1/8"	41/64"	7.25
SF-16-32	1"	2"	7/16"	2-1/8"	41/64"	7.50
ESF-16-32	1"	2"	7/16"	2-1/8"	1-1/4"	9.75

## Flanged Wheel Bearings

Order No.	A	B	C	D	E	List
150-003	3/8"	1-1/8"	1/4"	1-1/4"	7/16"	\$3.80
150-005	1/2"	1-1/8"	1/4"	1-1/2"	7/16"	3.80
150-089	1/2"	1-3/8"	3/8"	1-1/2"	17/32"	20.53
150-094	5/8"	1-3/8"	7/16"	1-1/2"	9/16"	31.30
Dealer Schedule:	1 To 9					203
	10 or more assorted					203 & 101

**NEW PRICES AS OF 6/10/2021**

ALL PRICES SUBJECT TO CHANGE WITHOUT NOTICE.

**IPTCI**  
**Ball Bearings**  
**Medium Duty**

**SET SCREW LOCKING**  
 Spherical, Self-Aligning

Greater Load Carrying Capacity  
 Than "UC" Series Inserts

**WIDE INNER RING**  
**RELUBRICATABLE**  
 Grease Groove on Collar Side of Outer Race  
 and Grease Hole on Back Side of Outer Race

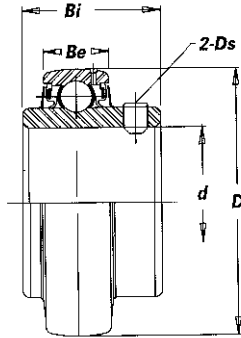

**IPTCI**  
**Ball Bearings**  
**SET SCREW LOCKING**  
 Spherical, Self-Aligning

**WIDE INNER RING**  
**RELUBRICATABLE**  
 Grease Groove on Collar Side of Outer Race  
 and Grease Hole on Back Side of Outer Race

Order No.	(d) Shaft	Flange Series	(D) O.D.	Price
UCX05-14	7/8"	62	2.4409	\$23.62
UCX05-15	15/16"	62	2.4409	23.62
UCX05-16	1"	62	2.4409	23.62
UCX06-18	1-1/8"	72	2.8346	28.95
UCX06-19	1-3/16"	72	2.8346	28.95
UCX06-20	1-1/4"	72	2.8346	28.95
UCX07-22	1-3/8"	80	3.1496	35.05
UCX07-23	1-7/16"	80	3.1496	35.05
UCX08-24	1-1/2"	85	3.3465	38.86
UCX09-26	1-5/8"	90	3.5433	48.00
UCX09-27	1-11/16"	90	3.5433	48.00
UCX09-28	1-3/4"	90	3.5433	48.00
UCX10-30	1-7/8"	100	3.9370	60.19
UCX10-31	1-15/16"	100	3.9370	60.19
UCX10-32	2"	100	3.9370	57.10
UCX11-34	2-1/8"	110	4.3307	118.09
UCX11-35	2-3/16"	110	4.3307	84.57
UCX11-36	2-1/4"	110	4.3307	76.95
UCX12-38	2-3/8"	120	4.7244	109.71
UCX12-39	2-7/16"	120	4.7244	109.71
UCX13-40	2-1/2"	125	4.9213	155.42
UCX14-43	2-11/16"	130	5.1181	176.76
UCX15-47	2-15/16"	140	5.5118	230.09
UCX15-48	3"	140	5.5118	230.09
UCX17-55	3-7/16"	160	6.2992	383.99
UCX17-56	3-1/2"	160	6.2992	408.37
UCX20-63	3-15/16"	190	7.4803	528.74
UCX20-64	4"	190	7.4803	528.74

Order No.	(d) Shaft	Flange Series	(D) O.D.	Price
UCW201-08	1/2"	40	1.5748	\$17.52
UCW202-10	5/8"	40	1.5748	16.76
UC201-08	1/2"	47	1.8504	17.52
UC202-10	5/8"	47	1.8504	16.76
UC204-12	3/4"	47	1.8504	14.48
UC205-14	7/8"	52	2.0472	15.24
UC205-15	15/16"	52	2.0472	15.24
UC205-16	1"	52	2.0472	15.24
UC206-17	1-1/16"	62	2.4409	19.81
UC206-18	1-1/8"	62	2.4409	19.81
UC206-19	1-3/16"	62	2.4409	19.81
UC206-20	1-1/4" Sm.	62	2.4409	19.81
UC207-20	1-1/4" Std.	72	2.8346	23.62
UC207-21	1-5/16"	72	2.8346	23.62
UC207-22	1-3/8"	72	2.8346	23.62
UC207-23	1-7/16"	72	2.8346	23.62
UC208-24	1-1/2"	80	3.1496	28.95
UC208-25	1-9/16"	80	3.1496	28.95
UC209-26	1-5/8"	85	3.3465	32.00
UC209-27	1-11/16"	85	3.3465	32.00
UC209-28	1-3/4"	85	3.3465	32.00
UC210-30	1-7/8"	90	3.5433	38.86
UC210-31	1-15/16"	90	3.5433	38.86
UC210-32	2" Sm.	90	3.5433	38.86
UC211-32	2" Std.	100	3.9370	48.76
UC211-34	2-1/8"	100	3.9370	48.76
UC211-35	2-3/16"	100	3.9370	48.76
UC212-36	2-1/4"	110	4.3307	67.81
UC212-38	2-3/8"	110	4.3307	67.81
UC212-39	2-7/16"	110	4.3307	67.81
UC213-40	2-1/2"	120	4.7244	92.19
UC214-43	2-11/16"	125	4.9210	118.09
UC214-44	2-3/4"	125	4.9210	118.09
UC215-47	2-15/16"	130	5.1181	138.66
UC215-48	3"	130	5.1181	138.66
UC218-56	3-1/2"	160	6.2992	366.95

All Prices Are Subject To Change Without Notice

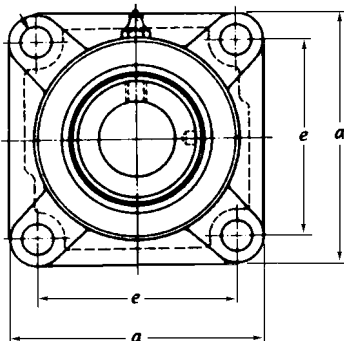

**CAST IRON FLANGE & BEARING UNITS (FOUR BOLT)**

Complete Unit	Shaft Size	Bearing	Housing	(A)	(E)	Price
UCFX15-47	2-15/16"	UCX15-47	FX15	7-3/4"	6"	\$267.42
UCFX17-55	3-7/16"	UCX17-55	FX17	8-7/16"	6-3/4"	432.75
UCFX17-56	3-1/2"	UCX17-56	FX17	8-7/16"	6-3/4"	483.79
UCFX20-63	3-15/16"	UCX20-63	FX20	10-9/16"	8-5/16"	861.69

**SET SCREW TYPE**

Housing	Bolt	Only	MM	(A)	(E)	Holes	Price
FX13	125	7-3/8"	5-7/8"	9/16"			\$82.96
FX15	140	7-3/4"	6"	11/16"			126.97
FX17	160	8-7/16"	6-3/4"	11/16"			159.14
FX20	190	10-9/16"	8-5/16"	1"			315.74

# IPTCI

## BALL BEARINGS

SELF-ALIGNING WITH COLLARS  
 Extended Inner Ring One Side Only  
 SPHERICAL  
 ECCENTRIC CAM LOCKING  
 RELUBRICATABLE

Grease Groove on Collar Side of Outer Race  
 and Grease Hole on Back Side of Outer Race

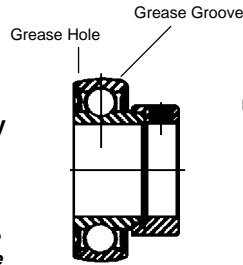

Order No.	Shaft	Flange	O.D.	Price
SA201-08G	1/2"	40	1.574	\$19.05
SA202-10G	5/8"	40	1.574	19.05
SA204-12G	3/4"	47	1.850	14.48
SA205-14G	7/8"	52	2.047	16.00
SA205-15G	15/16"	52	2.047	16.00
SA205-16G	1"	52	2.047	16.00
SA206-17G	1-1/16"	62	2.440	19.81
SA206-18G	1-1/8"	62	2.440	19.81
SA206-19G	1-3/16"	62	2.440	19.81
SA206-20G	1-1/4" sm	62	2.440	19.81
SA207-20G	1-1/4" std	72	2.834	23.62
SA207-21G	1-5/16"	72	2.834	23.62
SA207-22G	1-3/8"	72	2.834	23.62
SA207-23G	1-7/16"	72	2.834	23.62
SA208-24G	1-1/2"	80	3.149	28.95
SA209-26G	1-5/8"	85	3.346	33.52
SA209-27G	1-11/16"	85	3.346	33.52
SA209-28G	1-3/4"	85	3.346	33.52
SA210-30G	1-7/8"	90	3.543	37.33
SA210-32G	2" sm	90	3.543	37.33
SA211-32G	2" std	100	3.937	47.24
SA211-35G	2-3/16"	100	3.937	47.24

NEW PRICES AS OF 4/24/2021

# IPTCI

## BALL BEARINGS

SPHERICAL  
 ECCENTRIC CAM LOCKING  
 WIDE INNER RING  
 RELUBRICATABLE

Grease Groove on Collar Side of Outer Race  
 and Grease Hole on Back Side of Outer Race

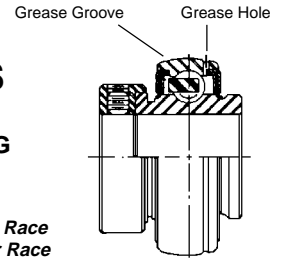

Order No.	Shaft	Flange	O.D.	Price
NA204-12	3/4"	47	1.850	\$16.00
NA205-14	7/8"	52	2.047	17.52
NA205-15	15/16"	52	2.047	17.52
NA205-16	1"	52	2.047	17.52
NA206-17	1-1/16"	62	2.440	22.09
NA206-18	1-1/8"	62	2.440	22.09
NA206-19	1-3/16"	62	2.440	22.09
NA206-20	1-1/4" sm	62	2.440	22.09
NA207-20	1-1/4" std	72	2.834	29.50
NA207-22	1-3/8"	72	2.834	25.90
NA207-23	1-7/16"	72	2.834	25.90
NA208-24	1-1/2"	80	3.149	31.24
NA208-25	1-9/16"	80	3.149	31.24
NA209-26	1-5/8"	85	3.346	35.05
NA209-27	1-11/16"	85	3.346	35.05
NA209-28	1-3/4"	85	3.346	35.05
NA210-30	1-7/8"	90	3.543	43.43
NA210-31	1-15/16"	90	3.543	43.43
NA210-32	2" sm	90	3.543	43.43
NA211-32	2" std	100	3.937	54.09
NA211-34	2-1/8"	100	3.937	54.09
NA211-35	2-3/16"	100	3.937	54.09
NA212-36	2-1/4"	110	4.3307	87.62
NA212-38	2-3/8"	110	4.3307	87.62
NA212-39	2-7/16"	110	4.3307	87.62
NA213-40	2-1/2"	120	4.7244	110.47
NA215-47	2-15/16"	130	5.1181	149.33
NA215-48	3"	130	5.1181	149.33

# IPTCI

## BALL BEARINGS

SELF-ALIGNING WITH COLLARS  
 Extended Inner Ring One Side Only  
 SPHERICAL  
 ECCENTRIC CAM LOCKING  
 NON-RELUBRICATABLE

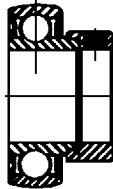

Order No.	Shaft	O.D.	Fafnir No.	Flange	Price
SA201-08N	1/2"	1.5748"	RA008RRB	40	\$19.05
SA202-10N	5/8"	1.5748"	RA010RRB	40	19.05
SA204-12N	3/4"	1.8504"	RA012RRB	47	14.48
SA205-14N	7/8"	2.0472"	RA014RRB	52	16.00
SA205-16N	1"	2.0472"	RA100RRB	52	12.95
SA206-18N	1-1/8"	2.4409"	RA102RRB	62	19.05
SA206-19N	1-3/16"	2.4409"	RA103RRB	62	19.05
SA206-20N	1-1/4" sm	2.4409"	RA103RRB2	62	19.05
SA207-20N	1-1/4" std	2.8346"	RA104RRB	72	23.62
SA207-22N	1-3/8"	2.8346"	RA106RRB	72	23.62
SA207-23N	1-7/16"	2.8346"	RA107RRB	72	23.62
SA208-24N	1-1/2"	3.1496"	RA108RRB	80	28.19
SA208-25N	1-9/16"	3.1496"	RA109RRB	80	28.19
SA209-28N	1-3/4"	3.3465"	RA112RRB	85	32.76

DEALER SCHEDULE THIS PAGE.....152

**For other sizes & styles of triple-ply sealed bearings, call for price and availability.**

# IPTCI

## BALL BEARINGS

SPHERICAL  
 ECCENTRIC CAM LOCKING  
 WIDE INNER RING  
 RELUBRICATABLE

Grease Groove on Collar Side of Outer Race  
 and Grease Hole on Back Side of Outer Race

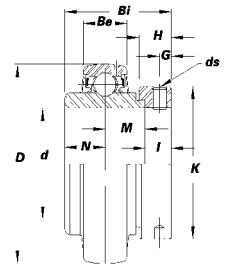

### TRIPLE-PLY SEAL

IPTCI Triple-ply (L3) Sealed bearings provide more protection in harsh environments. They are often an ideal choice for dirty, high-moisture applications such as those found in agriculture, turf, and car washes.



Order No.	Shaft	Flange	(D)	(Bi)	Price
NA207-23L3	1-7/16	72	2.8346	2.0118	\$33.52
NA208-24L3	1-1/2"	80	3.1496	2.2165	39.62
NA209-26L3	1-5/8"	85	3.3465	2.2165	44.19
NA209-28L3	1-3/4"	85	3.3465	2.2165	44.19
NA210-31L3	1-15/16"	90	3.5433	2.4685	54.86
NA211-32L3	2" std	100	3.9370	2.8110	66.28
NA211-35L3	2-3/16"	100	3.9370	2.8110	66.28



# IPTCI

## BALL BEARINGS

EXTENDED INNER RING ONE SIDE ONLY  
**CYLINDRICAL / FLAT OUTER RACE**  
 ECCENTRIC CAM LOCKING - NON-RELUBRICATABLE

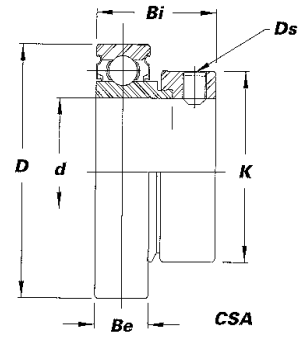

Order No.	(d) Shaft Size	(Be)	(D) O.D.	(Bi)	Fafnir No.	Price
CSA201-08N	1/2"	0.5118"	1.5748"	1.1260"	RA008RR	\$19.05
CSA202-10N	5/8"	0.5118"	1.5748"	1.1260"	RA010RR	19.05
CSA204-12N	3/4"	0.5906"	1.8504"	1.2205"	RA012RR	14.48
CSA205-14N	7/8"	0.5906"	2.0472"	1.2205"	RA014RR	16.00
CSA205-16N	1"	0.5906"	2.0472"	1.2205"	RA100RR	16.00
CSA206-18N	1-1/8"	0.7087"	2.4409"	1.4055"	RA102RR	19.05
CSA206-19N	1-3/16"	0.7087"	2.4409"	1.4055"	RA103RR	19.05
CSA206-20N	1-1/4" sm	0.7087"	2.4409"	1.4055"	RA103RR2	19.05
CSA207-20N	1-1/4" std	0.7480"	2.8346"	1.5315"	RA104RR	22.86
CSA207-22N	1-3/8"	0.7480"	2.8346"	1.5315"	RA106RR	22.86
CSA207-23N	1-7/16"	0.7480"	2.8346"	1.5315"	RA107RR	22.86
CSA208-24N	1-1/2"	0.8661"	3.1496"	1.7205"	RA108RR	28.19
CSA209-28N	1-3/4"	0.8661"	3.3465"	1.7205"	RA112RR	31.24
CSA210-31N	1-15/16"	0.8661"	3.5433"	1.7205"	RA115RR	37.33
CSA211-32N	2"	0.9449"	3.9370"	1.9055"	RA200RR	53.33

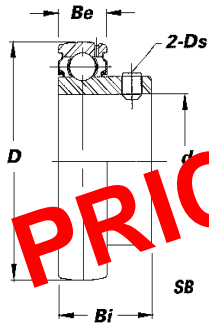

# IPTCI

## BALL BEARINGS

SELF-ALIGNING WITH SET SCREW LOCKING COLLAR

EXTENDED INNER RING ONE SIDE ONLY  
**SPHERICAL - RELUBRICATABLE**  
 Grease Groove on Collar Side of Outer Race  
 and Grease Hole on Back Side of Outer Race

Order No.	(d) Shaft Size	(Be)	(D) O.D.	(Bi)	Fafnir No.	Flange Series	Price
SB201-08G	1/2"	0.4724"	1.5748"	0.8661"	GYA008RRB	40	\$16.00
SB202-10G	5/8"	0.4724"	1.5748"	0.8661"	GYA010RRB	40	16.00
SB204-12G	3/4"	0.5512"	1.8504"	0.9843"	GYA012RRB	47	13.71
SB205-14G	7/8"	0.5906"	2.0472"	1.0630"	GYA014RRB	52	14.48
SB205-15G	15/16"	0.5906"	2.0472"	1.0630"	GYA015RRB	52	14.48
SB205-16G	1"	0.5906"	2.0472"	1.0630"	GYA100RRB	52	14.48
SB206-18G	1-1/8"	0.7087"	2.4409"	1.1811"	GYA102RRB	62	19.05
SB206-19G	1-3/16"	0.7087"	2.4409"	1.1811"	GYA103RRB	62	19.05
SB206-20G	1-1/4" sm	0.7087"	2.4409"	1.1811"	GYA103RRB2	62	19.05
SB207-20G	1-1/4" std	0.7480"	2.8346"	1.2992"	GYA104RRB	72	22.09
SB207-22G	1-3/8"	0.7480"	2.8346"	1.2992"	GYA106RRB	72	22.09
SB207-23G	1-7/16"	0.7480"	2.8346"	1.2992"	GYA107RRB	72	22.09
SB208-24G	1-1/2"	0.8661"	3.1496"	1.4173"	GYA108RRB	80	26.67



Wide inner race  
 Black Oxide Finish

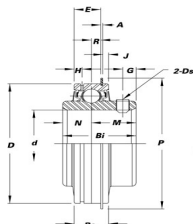

### CYLINDRICAL O.D. with SNAP RING SET SCREW LOCKING - EXTENDED INNER RING

Order No.	Shaft	D	Bi	Be	Price
ER205-14	7/8"	2.0472	1.3750	0.7500	\$17.52
ER205-16	1"	2.0472	1.3750	0.7500	17.52
ER206-20	1-1/4"	2.4409	1.5000	0.8661	21.33

# IPTCI

## Hanger Unit

### Cast Iron Housings

For "UC" Series Bearings Only

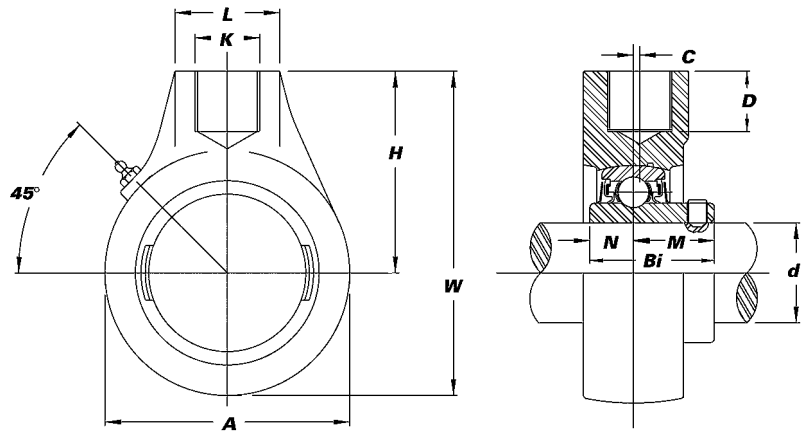

No.	For Bearing Shaft Size (d)	Brg. O.D. MM	(A)	(W)	(H)	(L)	(D)	(K) PTF	Price
HA204	1/2", 5/8", 3/4"	47	2-33/64"	3-25/32"	2-33/64"	1-9/16"	3/4"	3/4"-14	\$16.08
HA205	7/8", 15/16", 1"	52	3-1/16"	4-1/16"	2-33/64"	1-9/16"	3/4"	3/4"-14	19.47
HA206	1-1/16", 1-1/8", 1-3/16", 1-1/4" sm.	62	3-5/32"	4-3/32"	2-33/64"	1-9/16"	3/4"	3/4"-14	22.86
HA207	1-1/4" std., 1-5/16", 1-3/8", 1-7/16"	72	3-5/8"	4-9/16"	2-3/4"	1-9/16"	3/4"	3/4"-14	28.78
HA208	1-1/2", 1-9/16"	80	3-15/16"	4-27/64"	2-7/8"	1-9/16"	3/4"	3/4"-14	32.17

# IPTCI

## Take-Up Unit

### Cast Iron Housings

For "UC" Series Bearings Only

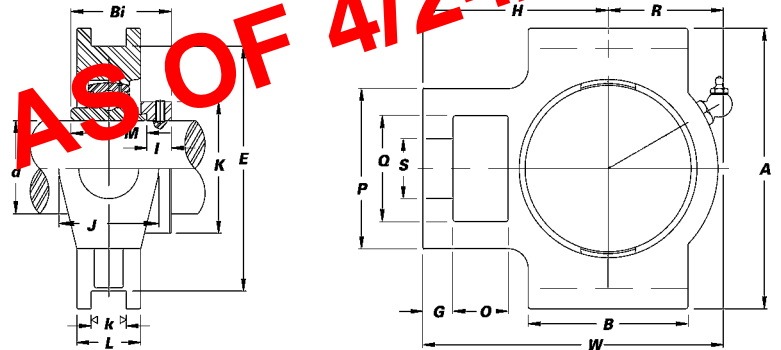

No.	For Bearing Shaft Size (d)	Brg. O.D. MM	(P)	(Q)	(S)	(E)	(A)	(W)	(H)	Price
T204	1/2", 5/8", 3/4"	47	2"	1-1/4"	3/4"	3"	3-1/2"	3-11/16"	2-13/32"	\$16.08
T205	7/8", 15/16", 1"	52	2"	1-1/4"	3/4"	3"	3-1/2"	3-13/16"	2-7/16"	19.47
T206	1-1/16", 1-1/8", 1-3/16", 1-1/4" sm.	62	2-7/32"	1-15/32"	55/64"	3-1/2"	4-1/32"	4-7/16"	2-3/4"	22.85
T207	1-1/4" std., 1-5/16", 1-3/8", 1-7/16"	72	2-17/32"	1-15/32"	55/64"	3-1/2"	4-1/32"	5-3/32"	3-1/16"	28.78
T208	1-1/2", 1-9/16"	80	3-9/32"	1-15/32"	1-9/64"	4"	4-1/2"	5-21/32"	3-15/32"	32.17

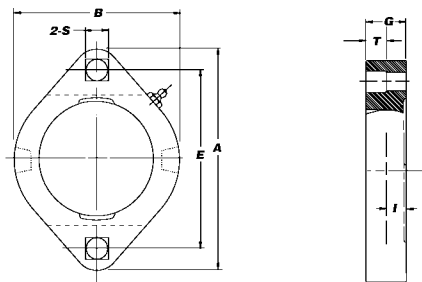

# IPTCI

## "SAMS" TWO BOLT

### CAST IRON HOUSINGS

Narrower Bolt Spacing  
for Narrow Inner Race "SA" Series Bearings Only

Order No.	For Bearing Shaft Size	Brg. O.D. (MM)	(A)	(B)	(E) Bolt Spacing (C-C)	(G)	(S) Bolt Size	Price
MS203G	1/2", 5/8"	40	3-3/16"	2-5/16"	2-1/2"	37/64"	1/4"	\$13.10
MS204G	3/4"	47	3-9/16"	2-5/8"	2-13/16"	43/64"	5/16"	13.10
MS205G	7/8", 1"	52	3-3/4"	2-51/64"	3"	11/16"	5/16"	15.15
MS206G	1-1/8", 1-3/16", 1-1/4" sm.	62	4-7/16"	3-5/16"	3-9/16"	13/16"	3/8"	17.45
MS207G	1-1/4" std., 1-3/8", 1-7/16"	72	4-15/16"	3-11/16"	3-15/16"	7/8"	3/8"	21.00

# IPTCI FOUR BOLT CAST IRON HOUSINGS

Order No.	For Bearing Shaft Size	Size (MM)	(A) O.D.	(E) Bolt Spacing	Bolt Size	Price
F203	1/2", 5/8"	40	3"	2-1/8"	3/8"	\$13.10
NF204	3/4"	47	3-3/8"	2-1/2"	3/8"	14.39
NF205	13/16", 7/8", 15/16", 1"	52	3-3/4"	2-3/4"	3/8"	16.08
NF206	1-1/16", 1-1/8", 1-3/16", 1-1/4" sm.	62	4-1/4"	3-1/4"	7/16"	18.62
NF207	1-1/4" std., 1-5/16", 1-3/8", 1-7/16"	72	4-19/32"	3-5/8"	7/16"	22.01
NF208	1-1/2", 1-9/16"	80	5-1/8"	4"	1/2"	25.39
NF209	1-5/8", 1-11/16", 1-3/4"	85	5-13/32"	4-1/8"	9/16"	30.47
NF210	1-13/16", 1-7/8", 1-15/16", 2" sm.	90	5-5/8"	4-3/8"	9/16"	36.40
NF211	2" std., 2-1/8", 2-3/16"	100	6-3/8"	5-1/8"	5/8"	40.63
NF212	2-1/4", 2-3/8", 2-7/16"	110	6-7/8"	5-5/8"	5/8"	48.25
NF213	2-1/2"	120	7-3/8"	5-7/8"	3/4"	56.71
NF214	2-11/16", 2-3/4"	125	7-19/32"	5-63/64"	3/4"	66.02
NF215	2-15/16", 3", 3-1/2"	130	7-3/4"	6"	3/4"	81.26

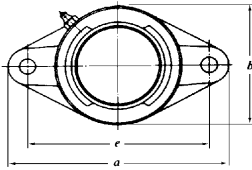
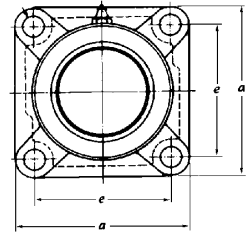

# IPTCI TWO BOLT CAST IRON HOUSINGS

Order No.	For Bearing Shaft Size	Size (MM)	(A)	(B)	(E) Bolt Spacing (C-C)	Bolt Size	Price
FT203	1/2", 5/8"	40	4-13/32"	2-3/8"	3"	5/16"	\$13.10
FL204	3/4"	47	4-7/16"	2-3/8"	3-17/32"	5/16"	14.39
FL205	13/16", 7/8", 15/16", 1"	52	5-1/8"	2-11/16"	3-57/64"	3/8"	16.08
FL206	1-1/16", 1-1/8", 1-3/16", 1-1/4" sm.	62	5-13/16"	3-5/32"	4-19/32"	3/8"	18.62
FL207	1-1/4" std., 1-5/16", 1-3/8", 1-7/16"	72	6-11/32"	3-17/32"	5-1/8"	7/16"	22.01
FL208	1-1/2", 1-9/16"	80	6-7/8"	3-15/16"	5-21/32"	7/16"	25.39
FL209	1-5/8", 1-11/16", 1-3/4"	85	7-13/32"	4-1/4"	5-27/32"	1/2"	30.47
FL210	1-13/16", 1-7/8", 1-15/16", 2" sm.	90	7-3/4"	4-17/32"	6-3/16"	1/2"	36.40
FL211	1-7/8", 1-15/16", 2"	100	8-13/16"	5-1/8"	7-1/4"	9/16"	40.63

NEW PRICES AS OF 4/24/2021

# IPTCI THREE BOLT CAST IRON HOUSINGS

Order No.	For Bearing Shaft Size	Size (MM)	(A) O.D.	(B) Bolt Spacing	(S) Bolt Size	Price
RFB204	3/4"	47	3-9/16"	2-13/16"	5/16"	\$16.08
RFB205	7/8", 15/16", 1"	52	3-3/4"	3"	5/16"	19.47
RFB206	1-1/16", 1-1/8", 1-3/16" N 1-1/4" sm.	62	4-7/16"	3-9/16"	3/8"	22.85
RFB207	1-1/4" std., 1-5/16", 1-3/8", 1-7/16"	72	4-13/16"	3-15/16"	3/8"	26.00

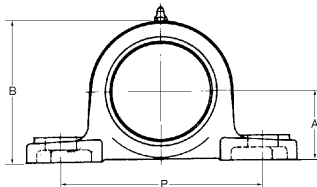
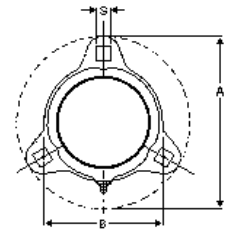

# IPTCI PILLOW BLOCK CAST IRON HOUSINGS

Order No.	For Bearing Shaft Size	Size MM	(A) Shaft Height	(B) Housing Height	(P) Bolt Spacing (C-C)	Bolt Size	Price
PL203	1/2", 5/8"	40	1-1/16"	2-15/64"	3-5/8"	3/8"	\$14.39
PL204	3/4"	47	1-1/4"	2-1/2"	3-3/4"	3/8"	14.39
PL205	13/16", 7/8", 15/16", 1"	52	1-5/16"	2-45/64"	4-1/8"	3/8"	16.08
PL206	1-1/16", 1-1/8", 1-3/16", 1-1/4" sm.	62	1-9/16"	3-5/32"	4-3/4"	1/2"	18.62
PL207	1-1/4" std., 1-5/16", 1-3/8", 1-7/16"	72	1-13/16"	3-21/32"	5"	1/2"	22.01
PL208	1-1/2", 1-9/16"	80	1-15/16"	4"	5-7/16"	1/2"	25.39
PL209	1-5/8", 1-11/16", 1-3/4"	85	2-1/16"	4-7/32"	5-3/4"	1/2"	30.47
PL210	1-13/16", 1-7/8", 1-15/16", 2" sm.	90	2-3/16"	4-29/64"	6-1/4"	5/8"	36.40
PL211	2" std., 2-1/8", 2-3/16"	100	2-7/16"	4-61/64"	7"	5/8"	40.63
PL212	2-1/4", 2-3/8", 2-7/16"	110	2-11/16"	5-13/32"	7-3/8"	5/8"	48.25
PL213	2-1/2"	120	2-11/16"	5-7/16"	7-5/8"	5/8"	56.71
PL215	2-15/16", 3", 3-1/2"	130	3-1/4"	6-33/64"	8-1/2"	7/8"	81.26

## Three-Bolt & Four-Bolt Flanges For Standard Ball Bearing Units

The flanges listed below are standard and are dimensionally the same as supplied by the leading ball bearing manufacturers.

Two flanges are required to house a standard ball bearing unit. The spherical inside surface of each pair of flanges mates with the spherical outer surface of the ball bearing ring to provide self-alignment in any direction. **All Flanges Are Zinc Plated.**

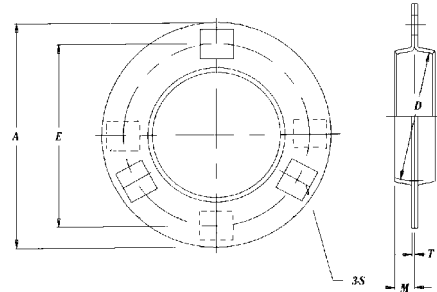

### THREE BOLT

Order No.	For Bearing Shaft Size	Fafnir No.	A	E	Per Each
40MM-3-ZP	1/2", 5/8"	40MS-ZP	3-3/16"	2-1/2"	\$2.41
47MM-3-ZP	3/4"	47MS-ZP	3-9/16"	2-13/16"	2.45
52MM-3-ZP	7/8", 15/16", 1"	52MS-ZP	3-3/4"	3"	2.46
62MM-3-ZP	1-1/16", 1-1/8", 1-3/16", 1-1/4" sm	62MS-ZP	4-7/16"	3-9/16"	3.02
72MM-3-ZP	1-1/4" std, 1-5/16", 1-3/8", 1-7/16"	72MS-ZP	4-13/16"	3-15/16"	3.09

### FOUR BOLT

Order No.	For Bearing Shaft Size	Fafnir No.	A	E	Per Each
80MM-4-ZP	1-1/2", 1-9/16"	80MS-ZP	5-13/16"	4-11/16"	4.98
85MM-4-ZP	1-5/8", 1-11/16", 1-3/4"	85MS-ZP	5-7/8"	4-3/4"	6.03
90MM-4-ZP	1-13/16", 1-7/8", 1-15/16"	90MS-ZP	6-1/8"	5"	6.06
100MM-4-ZP	2", 2-1/16", 2-1/8", 2-3/16"	100MS-ZP	6-9/16"	5-7/16"	7.84

NEW PRICES AS OF 4/26/2021

## Three Bolt & Four-Bolt Re-Lube Flanges for Standard Ball Bearing Units

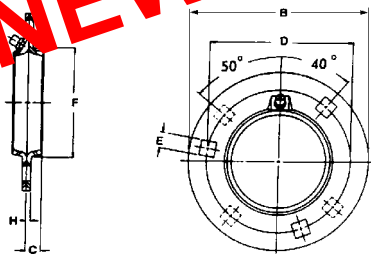

These flanges are used where additional lubrication is required. For example, where dust, dirt, excessive moisture, or other contaminants are present. The additional lubrication increases the life of the ball bearing unit by flushing out any contaminants that may be present, plus lubricating the ball bearing unit over a longer period of time.

The flange with the grease fitting, also has a inner grease groove, which allows the grease to enter the holes in the outer ring of the ball bearing. The other matching flange has a similar grease groove, so the ball bearing can be reversed, and still be lubricated.

**1 Flange w/Zerk & 1 Flange (Plain) Makes A Pair.**

### THREE BOLT HOLE

Order No.	For Bearing Shaft Size	Fafnir No.	B	D	E	Per Each
52MM-3G-ZP w/Zerk	13/16", 7/8", 15/16", 1"	G52MSA-ZP	3-3/4"	3"	11/32"	\$3.25
52MM-3GP-ZP (Plain)	13/16", 7/8", 15/16", 1"	G52MSB-ZP	3-3/4"	3"	11/32"	2.30
62MM-3G-ZP w/Zerk	1-1/16", 1-1/8", 1-3/16", 1-1/4" sm	G62MSA-ZP	4-7/16"	3-9/16"	13/32"	3.95
62MM-3GP-ZP (Plain)	1-1/16", 1-1/8", 1-3/16", 1-1/4" sm	G62MSB-ZP	4-7/16"	3-9/16"	13/32"	3.53
72MM-3G-ZP w/Zerk	1-1/4" std, 1-5/16", 1-3/8", 1-7/16"	G72MSA-ZP	4-13/16"	3-15/16"	13/32"	4.75
72MM-3GP-ZP (Plain)	1-1/4" std, 1-5/16", 1-3/8", 1-7/16"	G72MSB-ZP	4-13/16"	3-15/16"	13/32"	3.70

### FOUR BOLT HOLE

Order No.	For Bearing Shaft Size	Fafnir No.	B	D	E	Per Each
80MM-4G-ZP w/Zerk	1-1/2", 1-9/16"	G80MSA-ZP	5-13/16"	4-11/16"	17/32"	\$7.89
80MM-4GP-ZP (Plain)	1-1/2", 1-9/16"	G80MSB-ZP	5-13/16"	4-11/16"	17/32"	6.53
85MM-4G-ZP w/Zerk	1-5/8", 1-11/16", 1-3/4"	G85MSA-ZP	5-7/8"	4-3/4"	17/32"	8.23
85MM-4GP-ZP (Plain)	1-5/8", 1-11/16", 1-3/4"	G85MSB-ZP	5-7/8"	4-3/4"	17/32"	6.06
90MM-4G-ZP w/Zerk	1-13/16", 1-7/8", 1-15/16"	G90MSA-ZP	6-1/8"	5"	17/32"	10.38
90MM-4GP-ZP (Plain)	1-13/16", 1-7/8", 1-15/16"	G90MSB-ZP	6-1/8"	5"	17/32"	9.49
100MM-4G-ZP w/Zerk	2", 2-1/16", 2-1/8", 2-3/16"	G100MSA-ZP	6-9/16"	5-7/16"	17/32"	11.64
100MM-4GP-ZP (Plain)	2", 2-1/16", 2-1/8", 2-3/16"	G100MSB-ZP	6-9/16"	5-7/16"	17/32"	10.05

Dealer Schedule This Page: 1 To 19 Each.....152      20 Each Or More (Flanges May Be Assorted).....152 & 102



## Two-Bolt Flanges For Standard Ball Bearing Units

All Flanges Are Zinc Plated.

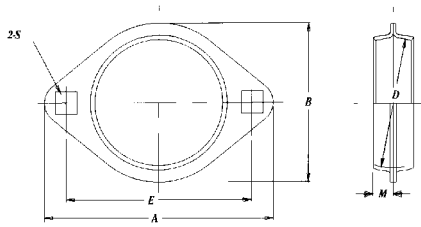

Fits Bearing Outside Dia.		Carriage Bolt Size	Fits Bearing Outside Dia.		Carriage Bolt Size		
Series	Ins.	M.M.	Inch	Series	Ins.	M.M.	Inch
40	1.574	40	Use 1/4 x 3/4	80	3.149	80	1/2 x 3/4
47	1.850	47	5/16 x 3/4	85	3.346	85	1/2 x 3/4
52	2.047	52	5/16 x 3/4	90	3.543	90	1/2 x 3/4
62	2.440	62	3/8 x 3/4	100	3.937	100	1/2 x 3/4
72	2.834	72	3/8 x 3/4				

Order No.	For Bearing Shaft Size	Fafnir No.	B	A	E	Per Each
40M-2-ZP	1/2", 5/8"	40MST-ZP	2-5/16"	3-3/16"	2-1/2"	\$1.30
47M-2-ZP	3/4"	47MST-ZP	2-5/8"	3-9/16"	2-13/16"	1.60
52M-2-ZP	7/8", 15/16", 1"	52MST-ZP	2-51/64"	3-3/4"	3"	1.99
62M-2-ZP	1-1/16", 1-1/8", 1-3/16", 1-1/4" sm	62MST-ZP	3-5/16"	4-7/16"	3-9/16"	2.18
72M-2-ZP	1-1/4" std, 1-5/16", 1-3/8", 1-7/16"	72MST-ZP	3-11/16"	4-15/16"	3-15/16"	2.32

## Triangular Three-Bolt Flanges For Standard Ball Bearing Units

(Zinc Plated)

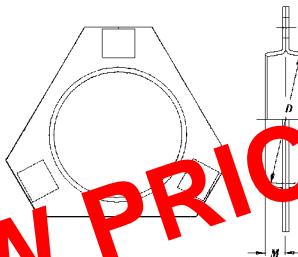

These triangular steel stampings are the same as our round 47MM-3-ZP, 52MM-3-ZP and 62MM-3-ZP parts. They are used where space is limited. One housing unit consists of identical self-aligning flanges. Each pair of flanges has a spherical inside surface which mates with spherical outer surface of the ball bearing to provide self-alignment in any direction. A minimum of space is required for installation as the unit protrudes thru the frame, plate, or panel on which it is installed.

Order No.	For Bearing Shaft Size	Fafnir No.	C O.D.	B Bolt Spacing (C-C)	Per Each
40MM-3T-ZP	1/2", 5/8"	40MSTR-ZP	2-23/32"	2-1/2"	\$1.70
47MM-3T-ZP	3/4"	47MSTR-ZP	3"	2-13/16"	1.82
52MM-3T-ZP	7/8", 15/16", 1"	52MSTR-ZP	3-1/8"	3"	1.95
62MM-3T-ZP	1-1/16", 1-1/8", 1-3/16", 1-1/4" sm	62MSTR-ZP	3-11/16"	3-9/16"	2.45
72MM-3T-ZP	1-1/4" std, 1-5/16", 1-3/8", 1-7/16"	72MSTR-ZP	4-5/32"	3-15/16"	3.33

## Heavy Duty Steel Pillow Block Sets For Standard Ball Bearing Units

(1 Set For Each Ball Bearing)

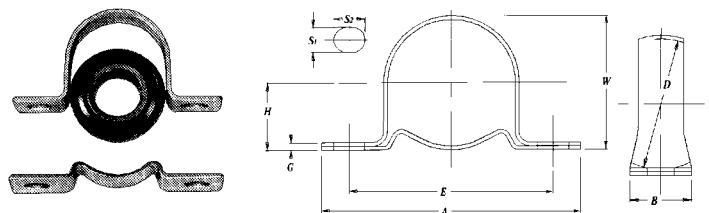

Order No.	For Bearing Shaft Size	Fafnir No.	E	H	W	Per Set
40MPB-NS-ZP	1/2", 9/16", 5/8"	40PB	2-11/16"	7/8"	1-3/4"	\$3.49
47MPB-NS-ZP	3/4"	47PB	3"	1"	2-1/16"	3.64
52MPB-NS-ZP	13/16", 7/8", 15/16", 1"	52PB	3-3/8"	1-1/8"	2-7/32"	3.70
62MPB-NS-ZP	1-1/16", 1-1/8", 1-3/16", 1-1/4" sm	62PB	3-3/4"	1-5/16"	2-5/8"	4.19
72MPB-NS-ZP	1-1/4" std, 1-5/16", 1-3/8", 1-7/16"	72PB	4-1/4"	1-9/16"	3-1/8"	5.17

Dealer Schedule This Page: 1 To 19 Each.....152      20 Each Or More (Flanges May Be Assorted).....152 & 102

Call **Central** Toll-Free 1-800-444-8666

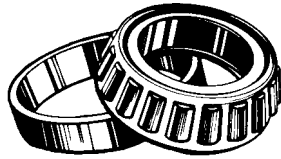

## Single Row Tapered Roller Bearings

One cup and one cone is a complete Tapered Roller Bearing. Cone will only fit cups of the same series and vice versa. Each series is set off by a ruled line. Taper roller bearings, most or which, are made to fractional inch dimensions.

Number	Type	Cone Bore	Each	Number	Type	Cone Bore	Each
4T-342A	Cone	1.6250	\$46.60	4T-09074	Cone	.7500	\$15.20
4T-342S	Cone	1.6880	32.12	4T-09081	Cone	.8120	44.94
4T-332	Cup		17.35	4T-09196	Cup		16.86
-----				-----			
4T-368A	Cone	2.0000	43.83	4T-LM11749	Cone	.6875	6.40
4T-362A	Cup		20.36	4T-LM11710	Cup		3.11
-----				-----			
4T-387A	Cone	2.2500	34.85	4T-LM11949	Cone	.7500	5.60
4T-387AS	Cone	2.2500	35.37	4T-LM11910	Cup		3.00
4T-382	Cup		18.92	-----			
4T-382A	Cup		14.58	4T-LM11949XL	Cone w/Seal	.7500	15.75
-----				4T-LM11910XL	Cup		6.00
4T-469	Cone	2.2500	80.40	-----			
4T-453A	Cup		34.05	4T-12580	Cone	.8125	23.85
-----				4T-12520	Cup		8.95
4T-497	Cone	3.3750	80.82	-----			
4T-493	Cup		42.90	4T-M12649	Cone	.8437	7.41
-----				4T-M12610	Cup		3.60
4T-1779	Cone	.9375	28.20	-----			
4T-1729	Cup		19.39	4T-13685	Cone	1.5000	22.55
-----				4T-13686	Cone	1.5000	27.72
4T-2776	Cone	1.5000	33.50	4T-13687	Cone	1.5000	22.11
4T-2788	Cone	1.5000	29.30	4T-13620	Cup		13.50
4T-2790	Cone	1.2125	37.53	4T-13621	Cup		11.12
4T-2720	Cup		14.39	-----			
-----				4T-14123A	Cone	1.2500	28.62
4T-2879	Cone	1.2500	70.21	4T-14136A	Cone	1.3750	27.50
4T-2820	Cup		27.51	4T-14137A	Cone	1.3750	18.71
-----				4T-14138A	Cone	1.3750	26.10
4T-3379	Cone	1.3750	93.34	4T-14274	Cup		6.00
4T-3320	Cup		34.10	4T-14276	Cup		5.00
-----				-----			
4T-3780	Cone	2.0000	40.84	4T-15101	Cone	1.0000	20.01
4T-3720	Cup		19.62	4T-15116	Cone	1.1855	25.40
-----				4T-15117	Cone	1.1811	29.46
4T-3984	Cone	2.6250	53.86	4T-15118	Cone	1.1895	20.15
4T-3920	Cup		28.51	4T-15120	Cone	1.1895	29.45
-----				4T-15123	Cone	1.2500	14.23
4T-02877	Cone	1.3750	29.57	4T-15126	Cone	1.2500	15.87
4T-02878	Cone	1.3750	30.16	4T-15245	Cup		6.30
4T-02820	Cup		12.72	4T-15250	Cup		11.05
-----				-----			
4T-07100	Cone	1.0000	16.24	4T-15580	Cone	1.0625	25.35
4T-07196	Cup		7.33	4T-15590	Cone	1.1250	22.40
-----				4T-15520	Cup		11.05
4T-09067	Cone	.7500	21.82	-----			
4T-09194	Cup		8.40	4T-18590	Cone	1.6250	33.65
4T-09195	Cup		12.27	4T-18520	Cup		16.60
-----				-----			
				4T-18790	Cone	2.0000	33.50
				4T-18720	Cup		20.20

DEALER SCHEDULE THIS PAGE.....152

PRICES ARE SUBJECT TO CHANGE WITHOUT NOTICE.

Continued On The Following Pages

For bearings not shown...call for price and availability.

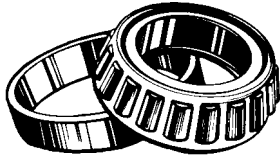

## Single Row Tapered Roller Bearings

Number	Type	Cone Bore	Each
4T-24780	Cone	1.6250	\$28.00
4T-24720	Cup		13.00
-----			
4T-25577	Cone	1.6880	34.35
4T-25580	Cone	1.7500	14.38
4T-25590	Cone	1.7960	13.43
4T-25520	Cup		7.28
4T-25521	Cup		14.95
4T-25523	Cup		14.97
-----			
4T-25877	Cone	1.3750	27.00
4T-25878	Cone	1.3750	32.40
4T-25880	Cone	1.4365	30.25
4T-25820	Cup		14.00
4T-25821	Cup		11.40
-----			
4T-26882	Cone	1.6250	42.37
4T-26820	Cup		31.05
4T-26823	Cup		28.97
-----			
4T-28580	Cone	2.0000	43.88
4T-28521	Cup		20.30
-----			
4T-28985	Cone	2.3750	66.35
4T-28920	Cup		38.00
-----			
4T-29590	Cone	2.5000	62.70
4T-29520	Cup		32.60
-----			
4T-LM29748	Cone	1.5000	13.75
4T-LM29749	Cone	1.5000	10.31
4T-LM29710	Cup		6.75
-----			
4T-39585	Cone	2.5000	92.66
4T-39590	Cone	2.6250	56.04
4T-39520	Cup		32.14
-----			
4T-L44643	Cone	1.0000	8.81
4T-L44649	Cone	1.0625	7.40
4T-L44610	Cup		3.11
-----			
4T-LM48548	Cone	1.3750	8.10
4T-LM48510	Cup		3.85

Number	Type	Cone Bore	Each
4T-LM48548XL	Cone w/Seal	1.3750	\$19.35
4T-LM48510XL	Cup		8.75
-----			
4T-LM67048	Cone	1.2500	6.75
4T-LM67048XL	Cone w/Seal	1.2500	14.30
4T-LM67010	Cup		3.45
-----			
4T-L68149	Cone	1.3780	7.75
4T-L68111	Cup		3.50
-----			
4T-JL69349	Cone	1.4961	7.85
4T-JL69310	Cup		4.00
-----			
4T-M86649	Cone	1.1875	20.71
4T-M86610	Cup		8.81
-----			
4T-M88048	Cone	1.3125	16.78
4T-M88010	Cup		8.15
-----			
4T-HM88649	Cone	1.3750	25.50
4T-HM88610	Cup		7.60
-----			
4T-LM104949	Cone	2.0000	13.15
4T-LM104911	Cup		7.05
-----			
4T-JLM104948	Cone	1.9685	27.00
4T-JLM104910	Cup		10.19
-----			
4T-HM212049	Cone	2.6250	125.10
4T-HM212011	Cup		30.22
-----			
4T-LM501349	Cone	1.6250	11.10
4T-LM501310	Cup		5.28
-----			
4T-JLM506849	Cone	2.1650	42.20
4T-JLM506810	Cup		18.67
-----			
4T-JM511946	Cone	2.5590	43.88
4T-JM511910	Cup		19.10
-----			
4T-LM603049	Cone	1.7812	11.65
4T-LM603011	Cup		6.40
-----			
4T-LM814849	Cone	2.500	64.90
4T-LM814810	Cup		41.22

Dealer Schedule.....152

**Continued On The Following Pages**

For bearings not shown...call for price and availability.

**Centralize with Central!**

PRICES ARE SUBJECT TO CHANGE WITHOUT NOTICE.

**Fax 1-800-342-7252**

**TAPERED  
ROLLER  
BEARING  
SETS**

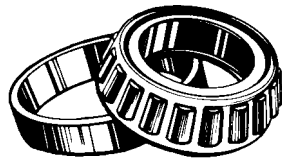

**Disc Harrow  
Square Bore  
Tapered Roller Bearings**

Number	Cone/Cup	List
4T-S01	LM11749/LM11710	\$9.50
4T-S02	LM11949/LM11910	8.06
4T-S03	M12649/M12610	11.00
4T-S04	L44649/L44610	10.45
4T-S05	LM48548/LM48510	11.93
4T-S06	LM67048/LM67010	10.21
4T-S12	LM12749/LM12710	9.31
4T-S14	L44643/L44610	10.50
4T-S16	LM12749/LM12711	9.69
4T-S17	L68149/L68111	11.25
4T-S18	JL69349/JL69310	11.75
4T-S19	07100/07196	22.19
4T-S35	LM501349/LM501310	16.15
4T-S37	LM603049/LM603011	18.05
4T-S38	LM104949/LM104911	20.20
4T-S52	25580/25520	17.40
4T-S54	25590/25520	17.70
4T-S56	LM29748/LM29710	16.05
4T-S63	M88048/M88010	21.15
4T-S70	LM29749/LM29710	15.30

Dealer Schedule.....152

Order No.	Description	Shaft	Price
<b>John Deere</b>			
4T-LM501334SD	.. Dbl. Row #JD8949	1.25"	84.12
4T-LM501310	..... Cup (2 required)		7.66
<b>Case/IH - Kewanee</b>			
4T-13678SD	..... Dbl. Row #469834R91	.. 1.156"	74.35
4T-13620	..... Cup (2 required)		13.50
<b>Popular Kits For The Above</b>			
DK-2	.... Includes: 1-LM501334SD, 2-LM501310, 2-200371 Seals ( <b>JD #AB12603</b> )		138.98
DK-3	.... Includes: 1-385SD, 2-382A, 2-200392 Seals ( <b>JD #AB14028</b> )		155.30
Dealer Schedule.....152			

All Prices Are Subject To Change Without Notice

**MODEL 625  
BEARING PACKER  
ATTACHMENT**

Wheel Bearing Packer

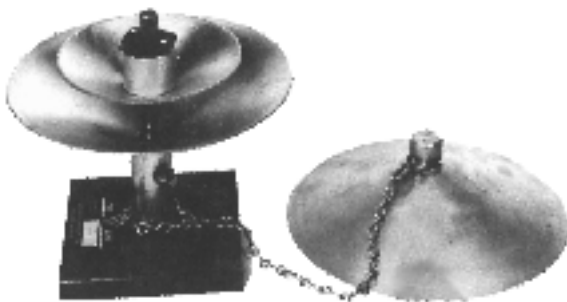

A portable or permanent bench type packer for use with hand or air operated grease gun. Includes dust cover and mounting base. Will handle bearings up to approximately 6" in diameter.

No.	Price
NS-625	Bearing Packer ..... \$40.23

Dealer Schedule.....152

ALL PRICES SUBJECT TO CHANGE WITHOUT NOTICE.

**At  
Central Supply  
We Ship  
Over 95%  
Of All Orders  
The Same Day!**

**Call Toll-Free  
1-800-444-8666**

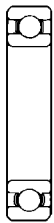

Open Type 60



Double Shielded 60 ZZ

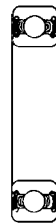

Double Sealed 60 LLU Contact Type

**EXTRA LIGHT DUTY**

**SINGLE ROW RADIAL BALL BEARINGS**

Order No.	Fafnir No.	BCA No.	I.D.	O.D.	Width	Price
6000ZZ	9100KDD		0.393	1.023	0.315	\$8.27
6000LLU	9100PP		0.393	1.023	0.315	10.00
6001ZZ	9101KDD	101SS	0.472	1.102	0.315	9.37
6002ZZ	9102KDD	102SS	0.590	1.259	0.354	9.61
6002LLU	9102PP	102CC	0.590	1.259	0.354	11.53
6003ZZ	9103KDD		0.669	1.378	0.393	10.02
6003LLU	9103PP	103CC	0.669	1.378	0.393	12.01
6004ZZ	9104KDD		0.787	1.653	0.472	13.66
6004LLU	9104PP	104CC	0.787	1.653	0.472	14.21
6005ZZ	9105KDD		0.984	1.850	0.472	13.23
6005LLU	9105PP	105CC	0.984	1.850	0.472	16.07
6006LLU	9106PP	106CC	1.181	2.165	0.511	18.39
6007LLU	9107PP	107DD	1.378	2.440	0.551	20.95
6008LLU	9108PP	108FFN	1.574	2.677	0.590	24.13
6013ZZ	9113KDD	113SS	2.559	3.937	0.708	44.66
6013LLU	9113PP		2.559	3.937	0.708	55.75

**SINGLE ROW RADIAL BALL BEARINGS**



Open Type 62

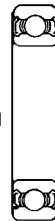

Double Shielded 62 ZZ

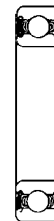

Double Sealed 62 LLU Contact Type

**LIGHT DUTY**

Order No.	Fafnir No.	BCA No.	I.D.	O.D.	Width	Price
6200ZZ	200KDD	200SS	0.393	1.181	0.354	\$5.27
6200LLU	200PP	200CC	0.393	1.181	0.354	5.71
6201LLU	201PP	201CC	0.472	1.259	0.393	6.59
6202ZZ	202KDD	202SS	0.590	1.378	0.433	6.11
6202LLU	202PP	202FF	0.590	1.378	0.433	6.78
6203	203K	203	0.669	1.574	0.472	4.67
6203ZZ	203KDD	203SS	0.669	1.574	0.472	5.17
6203LLU	203PP	203FF	0.669	1.574	0.472	5.45
6204ZZ	204KDD	204SS	0.787	1.850	0.551	6.97
6204LLU	204PP	204FF	0.787	1.850	0.551	7.72
6205	205K	205	0.984	2.047	0.590	8.60
6205ZZ	205KDD	205SS	0.984	2.047	0.590	9.14
6205LLU	205PP	205FF	0.984	2.047	0.590	10.55
6206	206K	206	1.181	2.440	0.629	12.92
6206ZZ	206KDD	206SS	1.181	2.440	0.629	10.34
6206LLU	206PP	206FF	1.181	2.440	0.629	11.71
6207	207K	207	1.378	2.834	0.669	12.92
6207ZZ	207KDD	207SS	1.378	2.834	0.669	13.54
6207LLU	207PP	207FF	1.378	2.834	0.669	19.29
6208ZZ	208KDD	208SS	1.574	3.149	0.708	20.80
6208LLU	208PP	208FF	1.574	3.149	0.708	24.11
6209ZZ	209KDD	209SS	1.771	3.346	0.748	26.99
6209LLU	209PP	209DD	1.771	3.346	0.748	28.29
6210	210K	210	1.968	3.543	0.787	23.04
6210ZZ	210KDD	210SS	1.968	3.543	0.787	30.36
6210LLU	210PP	210CC	1.968	3.543	0.787	33.31
6211ZZ	211KDD	211SS	2.165	3.937	0.826	44.43
6211LLU	211PP	211CC	2.165	3.937	0.826	43.48
6212	212K	212	2.362	4.330	0.866	43.25
6212LLU	212PP	212CC	2.362	4.330	0.866	54.87
6214	214K	214	2.755	4.921	0.944	56.77
6214ZZ	214KDD	214SS	2.755	4.921	0.944	66.36
6214LLU	214PP		2.755	4.921	0.944	71.57
6215ZZ	215KDD	215SS	2.952	5.118	0.984	87.81
6217ZZ	217KDD	217SS	3.346	5.905	1.102	104.25

**SINGLE ROW  
RADIAL  
BALL BEARINGS**

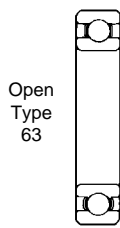

Open Type 63

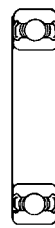

Double Shielded 63 ZZ

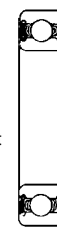

Double Sealed 63 LLU Contact Type

**MEDIUM DUTY**

Order No.	Fafnir No.	BCA No.	I.D.	O.D.	Width	Price
6302LLU	302NPP	302CC	0.590	1.653	0.511	\$11.03
6303	303K	303	0.669	1.850	0.551	9.08
6303ZZ	303KDD	303SS	0.699	1.850	0.551	9.95
6303LLU	303KDD	303DD	0.669	1.850	0.551	5.45
6304	304K	304	0.787	2.047	0.590	11.32
6304ZZ	304KDD	304SS	0.787	2.047	0.590	11.11
6304LLU	304NPP	304DD	0.787	2.047	0.590	11.87
6305ZZ	305KDD	305SS	0.984	2.440	0.669	12.62
6305LLU	305NPP	305DD	0.984	2.440	0.669	13.41
6306	306K	306	1.181	2.834	0.748	19.42
6306LLU	306NPP	306DD	1.181	2.834	0.748	28.21
6307	307K	307	1.378	3.149	0.863	20.52
6307LLU	307NPP	307FF	1.378	3.149	0.863	24.72
6308ZZ	308KDD	308SS	1.574	3.543	0.905	30.99
6308LLU	308NPP	308FF	1.574	3.543	0.905	32.81
6309ZZ	309KDD	309SS	1.771	3.937	0.984	43.25
6309LLU	309NPP	309DD	1.771	3.937	0.984	43.86
6310ZZ	310KDD	310SS	1.968	4.330	1.063	40.45
6310LLU	310NPP		1.968	4.330	1.063	45.72

**SINGLE ROW RADIAL BALL BEARINGS**

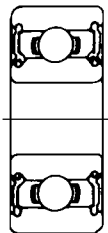

Double Sealed LLU (Contact Type)

**FRACTIONAL INCH BORE**

Double Shielded ZZ

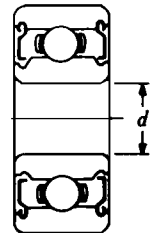

Order No.	Fafnir No.	BCA No.	I.D.	O.D.	Width	Price
R4ZZ	S1KDD7	R4SS	1/4"	5/8"	0.196	\$7.64
RA4ZZ	S1KDD		1/4"	3/4"	9/32"	9.56
RA4LLU	S1KPP		1/4"	3/4"	9/32"	7.64
R6ZZ	S3KDD	R6SS	3/8"	7/8"	9/32"	8.52
R6LLU	S3PP	R6CC	3/8"	7/8"	9/32"	11.72
R8ZZ	S5KDD	R8SS	1/2"	1-1/8"	5/16"	7.64
R8LLU	S5PP	R8CC	1/2"	1-1/8"	5/16"	11.72
R10ZZ	S7KDD	R10SS	5/8"	1-3/8"	11/32"	10.02
R10LLU	S7PP	R10CC	5/8"	1-3/8"	11/32"	11.02
R12ZZ	S8KDD	R12SS	3/4"	1-5/8"	7/16"	11.78
R14ZZ	S9KDD	R14SS	7/8"	1-7/8"	1/2"	14.82
R14LLU	S9PP		7/8"	1-7/8"	1/2"	16.55
R16ZZ	S10KDD	R16SS	1"	2"	1/2"	15.02
R16LLU	S10PP		1"	2"	1/2"	18.27

DEALER SCHEDULE THIS PAGE.....152

For bearings not shown...call for price and availability.

**CALL TOLL-FREE 1-800-444-8666**

**NATIONAL OIL SEALS**

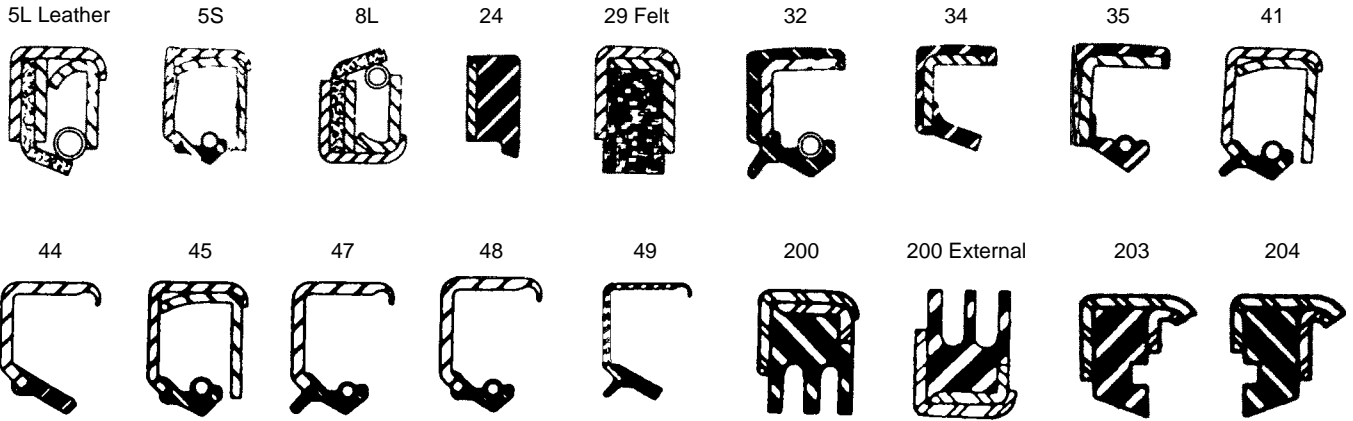

National Chicago Rawhide Zero Dup. Seal O.D. Seal Width Seal Type Price

<b>5/8" SHAFT SIZE .625</b>										
471466	6204	*	1.128	.250	47					\$6.80
<b>3/4" SHAFT SIZE .750</b>										
470954	7443	*	1.254	.250	47					5.50
471554	7513	*	1.379	.250	47					6.45
<b>7/8" SHAFT SIZE .875</b>										
471267	8660	*	1.379	.250	47					7.10
471570	8702	*	1.499	.250	47					7.30
<b>1" SHAFT SIZE 1.000</b>										
240731	9815		1.260	.125	24					4.85
471224	9843, 9878	*	1.500	.250	47					5.60
471689	9998	*	1.750	.250	47					8.80
204005	10035		1.785	.468	204					7.38
450593	10049	*	1.832	.296	45					11.35
471744	10114	*	1.987	.250	47					11.20
471760	10124	*	2.000	.250	47					9.70
321516		*	2.447	.375	32					19.60
<b>1-1/8" SHAFT SIZE 1.125</b>										
471652	11124	*	1.628	.250	47					6.00
204505	11161		1.780	.250	204					8.60
203020	11164		1.780	.468	203					8.90
204020	11164		1.785	.468	204					9.42
481792	11372	*	2.129	.250	48					11.50
<b>1-7/32" SHAFT SIZE 1.218</b>										
203025	12124		1.983	.406	203					10.60
<b>1-1/4" SHAFT SIZE 1.250</b>										
480356	16918M1	*	1.690	.375	48					9.75
471413	12364	*	1.750	.250	47					8.90
203029	12407		1.983	.406	203					10.70
204029	12411		1.983	.406	204					7.70
471750	12428	*	1.987	.250	47					10.90
471766	12458	*	2.000	.437	47					9.00
470163	12483		2.004	.437	47					8.70
471787	12530	*	2.066	.250	47					19.53
471795	12551	*	2.129	.250	47					13.00

**SEALS CONTINUED ON NEXT PAGE**

**\*ZERO DUPLICATION**

This interchange has been developed to provide a tool for consolidating or standardizing oil seal inventories. We call it ZERO DUPLICATION concept. (One seal for one shaft/bore combination in the narrowest width). Most of the ZERO DUPLICATION numbers are double lip seals: without an inner case for sizes under 3-1/4" O.D. and with inner case for sizes over 3-1/4" O.D.

Dealer Schedule: Broken Package.....184 Package of 10.....184 & 050

Quantities MAY NOT Be Assorted For Package Discount. **For seals not shown...call for price and availability.**

**NATIONAL OIL SEALS**

**For Seal Illustrations See Page 111**

National	Chicago Rawhide	Zero Dup.	Seal O.D.	Seal Width	Seal Type	Price
<b>1-1/4" SHAFT SIZE 1.250 (continued from preceding page)</b>						
471801	12577	*	2.256	.375	47	\$12.40
471808	12614	*	2.378	.375	47	17.75
471818	12621	*	2.441	.375	47	17.50
471407	12631	*	2.445	.375	47	19.30
<b>1-3/8" SHAFT SIZE 1.375</b>						
340853	12529		1.756	.187	34	8.60
472258	13569	*	2.004	.312	47	9.90
470774	13595	*	2.066	.375	47	12.10
472287	13602	*	2.110	.312	47	16.20
471192	13650	*	2.129	.312	47	9.50
470135	13649, 13666		2.129	.437	47	14.90
473214	13676	*	2.254	.312	47	15.60
204027	13711		2.332	.406	204	16.50
473215	13738, 13739	*	2.378	.312	47	12.20
471835	13839	*	2.506	.375	47	15.30
473258	13876	*	2.565	.375	47	12.90
472658	13918	*	2.839	.375	47	20.00
<b>1-7/16" SHAFT SIZE 1.437</b>						
473225	14283	*	2.378	.312	47	16.40
<b>1-1/2" SHAFT SIZE 1.500</b>						
472554			2.000	.312	47	15.60
481163	14855	*	2.004	.312	48	9.15
473227	14876	*	2.129	.312	47	11.00
470625	14939	*	2.254	.312	47	10.90
203013	14972		2.332	.406	203	12.10
204013	14974		2.332	.406	204	9.10
470380	15005	*	2.378	.312	47	6.00
410059	15005		2.378	.500	41	20.50
471344	15093	*	2.445	.375	47	15.80
410190	15176	*	2.565	.500	41	18.14
450984	15204	*	2.720	.468	45	19.90
473440	15214	*	2.750	.312	47	19.95
<b>1-5/8" SHAFT SIZE 1.625</b>						
473230	16062	*	2.254	.312	47	9.50
204017	16069		2.332	.406	204	7.32
473231	16085	*	2.378	.312	47	9.84
471419	16118	*	2.441	.375	47	9.95
473010	16246	*	2.500	.312	47	12.25
474216			2.562	.375	47	22.95
473232	16315	*	2.627	.312	47	13.90
473443	16364	*	2.754	.375	47	19.25
473444	16406	*	2.879	.375	47	20.30
<b>1-11/16" SHAFT SIZE 1.687</b>						
204008	16667		2.332	.500	204	9.90
473234	16719	*	2.506	.317	47	13.90
473235	16916	*	2.627	.312	47	24.10
473236	16900	*	2.750	.312	47	19.70
473446	16999	*	2.879	.375	47	21.05

**SEALS CONTINUED ON NEXT PAGE**

**\*ZERO DUPLICATION**

This interchange has been developed to provide a tool for consolidating or standardizing oil seal inventories. We call it ZERO DUPLICATION concept. (One seal for one shaft/bore combination in the narrowest width). Most of the ZERO DUPLICATION numbers are double lip seals: without an inner case for sizes under 3-1/4" O.D. and with inner case for sizes over 3-1/4" O.D.

Dealer Schedule: Broken Package.....184 Package of 10.....184 & 050

Quantities MAY NOT Be Assorted For Package Discount. **For seals not shown...call for price and availability.**



**NATIONAL OIL SEALS**

**For Seal Illustrations See Page 111**

National	Chicago Rawhide	Zero Dup.	Seal O.D.	Seal Width	Seal Type	Price
<b>1-3/4" SHAFT SIZE 1.750</b>						
450400	17231	*	2.254	.359	45	\$12.20
473237	17271	*	2.378	.312	47	9.70
471504	17285	*	2.441	.312	47	14.10
472164		*	2.506	.312	47	14.90
470361	17410	*	2.565	.500	47	14.90
472185	17443	*	2.623	.312	47	12.90
204038	17617		2.721	.359	204	9.28
204002	17609, 17611		2.721	.406	204	9.30
472179	17523	*	2.750	.312	47	13.65
450183	17557		2.754	.500	45	15.60
473448	17693	*	3.001	.375	47	17.20
471984	17707	*	3.005	.375	47	24.10
<b>1-13/16" SHAFT SIZE 1.812</b>						
451817	18039	*	2.441	.468	45	18.27
203006	17387		2.566	.500	203	16.26
473450	18242	*	2.879	.375	47	20.00
<b>1-27/32" SHAFT SIZE 1.843</b>						
473451	18425		2.623	.375	47	19.10
<b>1-7/8" SHAFT SIZE 1.875</b>						
350936	18562	*	2.571	.312	35	18.25
472439	18581	*	2.627	.312	47	10.60
473179	18690	*	2.758	.375	47	13.75
473238	18734	*	2.879	.312	47	15.30
203034	18808		3.000	.437	203	19.34
473239	18817	*	3.000	.312	47	17.30
<b>1-15/16" SHAFT SIZE 1.937</b>						
473460	19350	*	3.001	.375	47	20.95
<b>2" SHAFT SIZE 2.000</b>						
352541	19745, 19754		2.508	.250	35	16.40
471424	19762	*	2.627	.312	47	10.80
472492	19832	*	2.750	.312	47	13.90
472397	19993	*	3.000	.312	47	13.40
204508			3.062	.250	204	13.36
473463	20045	*	3.062	.375	47	18.30
455253	20140	*	3.543	.500	45	25.40
487945	20148		3.628	.375	48	29.65
<b>2-3/32" SHAFT SIZE 2.093</b>						
6590S	20952		2.721	.406	204	11.40
<b>2-1/8" SHAFT SIZE 2.125</b>						
473204	21061	*	2.754	.375	47	14.50
472409	21267	*	3.194	.375	47	15.90
413470	21352, 21353	*	3.375	.375	41	14.40
<b>2-3/16" SHAFT SIZE 2.187</b>						
472018	21759	*	3.005	.375	47	17.00
<b>2-1/4" SHAFT SIZE 2.250</b>						
473473	22382, 22391	*	3.000	.375	47	14.10
410520	22359		3.005	.500	41	23.90
471272	22354, 22358	*	3.005	.375	47	14.15
411253	22493	*	3.355	.375	41	25.40
412920	22532	*	3.376	.375	41	26.95
442109			3.376	.375	44	23.50

**SEALS CONTINUED ON NEXT PAGE**

**\*ZERO DUPLICATION**

This interchange has been developed to provide a tool for consolidating or standardizing oil seal inventories. We call it ZERO DUPLICATION concept. (One seal for one shaft/bore combination in the narrowest width). Most of the ZERO DUPLICATION numbers are double lip seals: without an inner case for sizes under 3-1/4" O.D. and with inner case for sizes over 3-1/4" O.D.

**NATIONAL OIL SEALS**

**For Seal Illustrations See Page 111**

National	Chicago Rawhide	Zero Dup.	Seal O.D.	Seal Width	Seal Type	Price
<b>2-9/32" SHAFT SIZE 2.281</b>						
493291 .....	22835 .....		3.159 .....	.375 .....	49 .....	\$23.57
<b>2-19/64" SHAFT SIZE 2.296</b>						
204035 .....	22870 .....		3.153 .....	.359 .....	204 .....	16.00
<b>2-3/8" SHAFT SIZE 2.375</b>						
410825 .....	23839 .....	*	3.628 .....	.375 .....	41 .....	30.10
<b>2-1/2" SHAFT SIZE 2.500</b>						
471271 .....	24898 .....	*	3.256 .....	.375 .....	47 .....	7.90
470605 .....	24954 .....	*	3.376 .....	.375 .....	47 .....	19.85
455079 .....	25091 .....	*	3.750 .....	.500 .....	45 .....	22.20
<b>2-3/4" SHAFT SIZE 2.750</b>						
417316 .....	27370 .....	*	3.751 .....	.375 .....	41 .....	24.50
<b>2-7/8" SHAFT SIZE 2.875</b>						
417344 .....	28686, 28687 .....	*	3.750 .....	.375 .....	41 .....	21.25
416921 .....	28761 .....	*	4.000 .....	.375 .....	41 .....	27.60
<b>3-7/8" SHAFT SIZE 3.875</b>						
417366 .....	38731 .....	*	5.250 .....	.500 .....	41 .....	43.00

**SPECIAL NATIONAL OIL SEALS**

**For Seal Illustrations See Page 111**

National	C/R No.	O.D.	Width	Type	Price	National	C/R No.	O.D.	Width	Type	Price
<b>1-1/8" SHAFT SIZE 1.125</b>						<b>FELT TYPE</b>					
203020 .....	11164 .....	1.785 .....	.468 .....	203 ..	\$8.90	<b>1-5/8" SHAFT SIZE 1.625</b>					
204505 .....	11161 .....	1.785 .....	.250 .....	204 ..	8.60	291099 .....	16284 .....	2.566 .....	.375 .....	29 ..	\$11.75
<b>1-1/2" SHAFT SIZE 1.500</b>						<b>LEATHER TYPE</b>					
41461S .....	15190 .....	2.627 .....	.250 .....	4S ..	11.80	<b>1-3/8" SHAFT SIZE 1.375</b>					
<b>1-5/8" SHAFT SIZE 1.625</b>						40395 .....	13548 .....	1.878 .....	.250 .....	4L ..	10.50
204500 .....		2.562 .....	.250 .....	4S ..	11.05	<b>EXTERNAL DESIGN</b>					
4763S .....	16289 .....	2.562 .....	.437 .....	# ..	11.96	<b>1-9/16" SHAFT SIZE 1.562</b>					
<b># Designed for specific application. Not for general use.</b>						200887 .....		2.237 .....	.290 .....	200 ..	21.70
<b>1-13/16" SHAFT SIZE 1.812</b>						<b>1-11/16" SHAFT SIZE 1.687</b>					
7186S .....	18127 .....	2.722 .....	.270 .....	200 ..	30.10	200886 .....	16818 .....	2.650 .....	.290 .....	200 ..	21.25
<b>1.945" SHAFT SIZE</b>						<b>1-3/4" SHAFT SIZE 1.750</b>					
200371 .....	19510 .....	2.895 .....	0.290 .....	200 ..	30.84	200854 .....		2.718 .....	.200 .....	200 ..	22.10
<b>2" SHAFT SIZE 2.000</b>						<b>1-29/32" SHAFT SIZE 1.911</b>					
40301S .....	20006 .....	3.005 .....	.250 .....	4S ..	18.90	200885 .....	23744 .....	2.900 .....	.290 .....	200 ..	25.55
<b>2-1/8" SHAFT SIZE 2.125</b>						<b>2" SHAFT SIZE 2.000</b>					
40566S .....	21101 .....	2.879 .....	.250 .....	4S ..	14.50	200881 .....	19844 .....	2.804 .....	.294 .....	200 ..	34.30
<b>2-1/4" SHAFT SIZE 2.250</b>						<b>2-1/4" SHAFT SIZE 2.250</b>					
40520S .....	22368 .....	3.005 .....	.250 .....	4S ..	13.80	200763 .....	22430 .....	3.250 .....	.285 .....	200 ..	26.60
<b>2-7/8" SHAFT SIZE 2.875</b>											
43086S .....	28800 .....	4.008 .....	.250 .....	4S ..	26.90						

**For seals not shown...call for price and availability.**

**\*ZERO DUPLICATION**

This interchange has been developed to provide a tool for consolidating or standardizing oil seal inventories. We call it ZERO DUPLICATION concept. (One seal for one shaft/bore combination in the narrowest width). Most of the ZERO DUPLICATION numbers are double lip seals: without an inner case for sizes under 3-1/4" O.D. and with inner case for sizes over 3-1/4" O.D.

Dealer Schedule: Broken Package.....184 Package of 10.....184 & 050 Quantities MAY NOT Be Assorted For Package Discount.

**Call Toll-Free 1-800-444-8666**

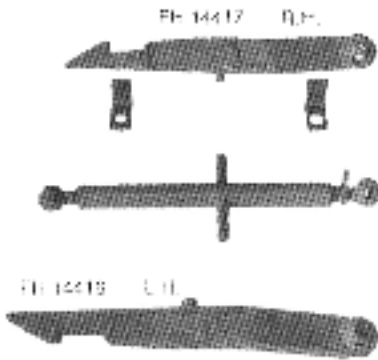

**Parts Breakdown For IHC Fast Hitch 3-Pt. Conversion Systems**

No.	Description	Conversion Model No.			Price
		FH14418	FH14419	FH14420	
TL123	Top Link	1		1	\$105.90
TL173	Top Link		1		78.80
P774	Pin		1		5.26
P791	Pin	1	1	1	.48
Dealer Schedule.....203					

No.	Description	Conversion Model No.			Price
		FH14418	FH14419	FH14420	
FH1448	RH Tong (Straight)	1			\$117.25
FH14416	LH Tong (Bent)		1	1	137.40
FH14417	RH Tong (Bent)		1	1	137.40
Dealer Schedule.....102					

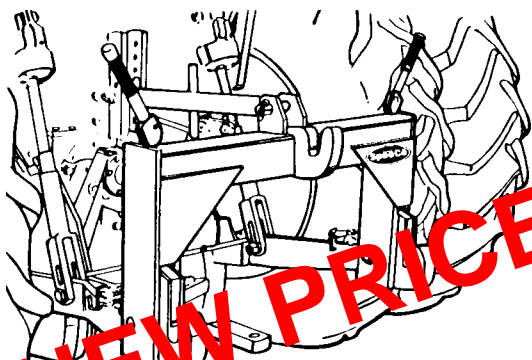

**Category I, II & III QUICK HITCH**

Save Time! Save Your Back!

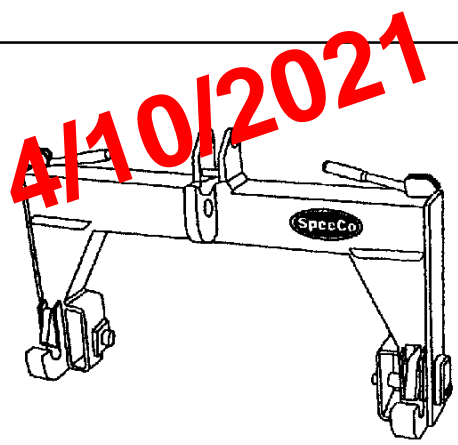

NEW CAT. 2/3 QUICK HITCH

NEW PRICES AS OF 4/10/2021

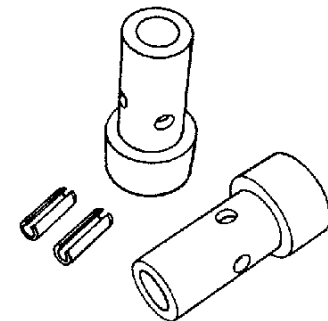
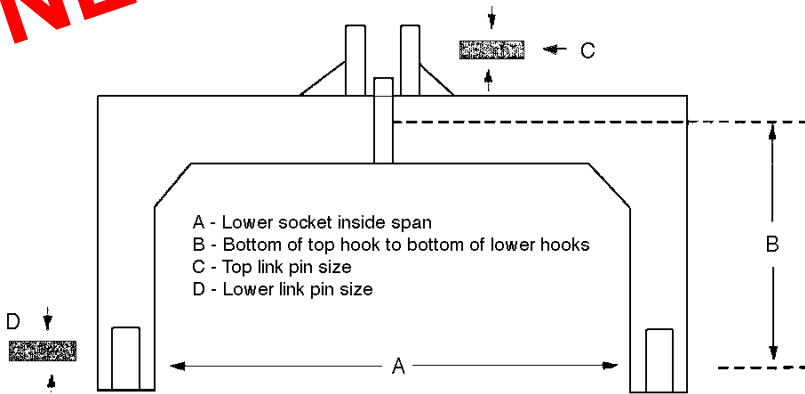

Quick Hitch Adapter Set

Easier disconnects and hook-ups of implements. No smashed toes and strained backs. Rubber handle grips on latches. Spring-loaded locking device

No.	Description	Max HP	A	B	C	D	Wt. Lbs.	Price
HF-141101	Cat.1 Quick Hitch for Cat.1 tractors and equip. w/toplink ball brkt	50	27-1/4"	Adjust.	3/4"	7/8"	76	\$339.50
HF-141102*	Cat.2 Std. Quick Hitch	100	32-3/4"	15"	1"	1-1/8"	134	523.52
HF-141107*	Cat.2 HD Quick Hitch	150	32-3/4"	15"	1"	1-1/8"	160	629.25
HF-141108	Quick Hitch for Cat.2/3 fits Cat.2 & 3 tractors w/Cat.3 equip.	225	32-3/4"/38-1/4"	19"	1-1/4"	1-7/16"	196	1041.44
HF-141103	Cat.3 Quick Hitch for Cat.3 tractors and equipment	225	38-1/4"	19"	1-1/4"	1-7/16"	182	724.35
HF-141106	Cat.3 Quick Hitch for narrow Cat.3 equipment	225	32-3/4"	19"	1-1/4"	1-7/16"	176	724.35

\* Converts Cat. 2 implement to Cat. 3 diameter of Quick Hitch latch.

(All Quick Hitches include adapter pins & bushings)

HF-141144	Cat. 1-2 Adapter Kit. Consists of 2 adapters and 2 roll pins.	\$32.19
HF-141130	Cat. 2-3 Adapter Kit. Consists of 2 adapters and 2 roll pins.	38.26

# THREE POINT LINKAGE EQUIPMENT

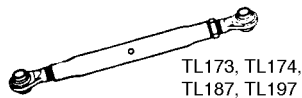
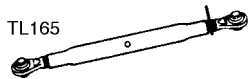

## ADJUSTABLE TOP LINKS

No.	Category	Type	Pin Hole Size	Body Length	Closed Length	Open Length	Threads	Price
TL197	0	Forged	5/8"	7-5/8"	10-1/2"	15-1/2"	3/4" NC	\$37.05
TL165	1	Forged	3/4"	16"	21"	31"	1-1/8" NC	38.57
TL173	2	Forged	1"	16"	23"	32"	1-1/4" NC	78.80
TL174	2	Forged	1"	16"	21"	31"	1-1/8" NC	46.84
TL187	3	Forged	1-1/4"	19-1/2"	25-1/2"	37"	1-3/8" NC	180.93

## TOP LINK REPAIR ENDS (will NOT fit Highland Top Links)



No.	Category	Type	Pin Hole Size	Thread Diameter	Thread Length	Overall Length	Price
RE113	1	Welded	3/4"	1" NC (LH)	5-1/2"	8"	\$17.60
RE1210	1	Welded	3/4"	1-1/4" NC (LH)	5-3/4"	8"	32.25
RE1212	2	Welded	1"	1-1/4" NC (LH)	5-3/4"	8-1/4"	31.05
RE1213	2	Welded	1"	1-1/4" NC (RH)	5-3/4"	8-1/4"	31.05

NEW PRICES AS OF 4/10/2021



## TOP LINK BALL SOCKETS

No.	Category	Description	Pin Hole Size	Length Thru Bore	Sleeve Width	Sleeve Outside Diam.	Price
B2225	0	Standard-Duty; Unplated	5/8"	1"	3/4"	2"	\$8.43
B215	1	Heavy-Duty; Plated	3/4"	1-5/8"	7/8"	2-1/8"	11.75
B235	1 & 2	Standard-Duty; Unplated	3/4" & 1"	1-1/2" & 1-1/4"	7/8"	2-3/8"	17.49
B236	1 & 2	Standard-Duty; Plated	3/4" & 1"	1-1/2" & 1-1/4"	7/8"	2-3/8"	17.49
B214	2	Standard-Duty; Plated	1"	1-3/4"	7/8"	2-3/8"	13.40
B2230	3	Standard-Duty; Plated	1-1/4"	1-3/4"	1-9/32"	3-1/8"	22.48



## DRAWBAR LOCK

Prevents Drawbar on Tractor 3-Point Hitch from Rotating. Allows for Faster and Easier Hitching. Attaches to Drawbar and Lift Arm in Minutes. For Category 1 Only. Painted Black.

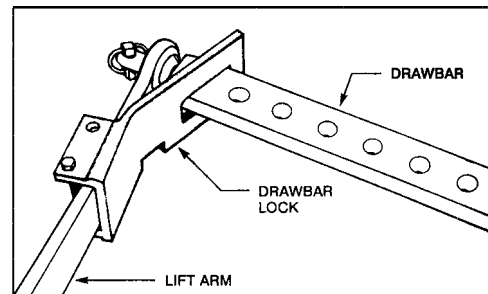

No.	Description	Price
DB4130	Drawbar Lock	\$37.20

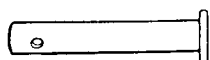

## Hitch Pins (Clevis Pins)

No.	Pin Diameter	Usable Length	Overall Length	Price
P7101	5/8"	4-3/4"	5-1/2"	\$3.01
P7102	3/4"	4-3/4"	5-1/2"	4.53
P7230	1-7/16"	4-1/2"	6"	13.55

## 3-Point Bushing Sets

Each Contains 3 Bushings  
Packaged In Plastic Sack



No.	Description	Price
BS-1-2	For Cat. 1 to 2 Linkage Contains 2 ea. B821, 1 ea. B831	\$5.11
BS-2-3	For Cat. 2 to 3 Linkage Contains 2 ea. B832, 1 ea. B833	6.62

# THREE POINT LINKAGE EQUIPMENT



## LIFT ARM BALL SOCKETS

No.	Category	Description	Pin Hole Size	Length Thru Bore	Sleeve Width	Sleeve Outside Diam.	Price
B2225	0	Standard-Duty; Unplated	5/8"	1"	3/4"	2"	\$8.43
B223	1	Standard-Duty; Plated	7/8"	1-3/8"	7/8"	2-3/8"	13.55
B232	1 & 2	Heavy-Duty; Plated	7/8" & 1-1/8"	1-3/4" Both	1-3/16"	2-3/4"	24.86
B233	1 & 2	Extra Heavy-Duty; Unplated	7/8" & 1-1/8"	1-3/4" Both	1-3/8"	3-1/8"	24.71
B234	1 & 2	Extra Heavy-Duty; Plated	7/8" & 1-1/8"	1-3/4" Both	1-3/8"	3-1/8"	27.31
B224	2	Standard-Duty; Plated	1-1/8"	1-5/16"	7/8"	2-3/8"	14.63
B2215	2	Extra Heavy-Duty; Unplated	1-1/8"	1-3/4"	1-3/8"	3-1/8"	21.56
B2216	2	Extra Heavy-Duty; Plated	1-1/8"	1-3/4"	1-3/8"	3-1/8"	22.48
B2231	3	Standard-Duty; Unplated	1-7/16"	1-3/4"	1-11/32"	3-1/2"	29.68
B2232	3	Standard-Duty; Plated	1-7/16"	1-3/4"	1-11/32"	3-1/2"	29.68

## REPLACEMENT BALLS

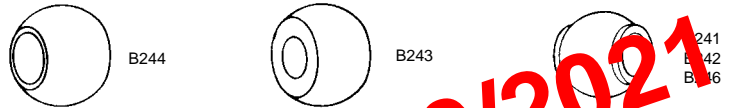

No.	Category	Description	Pin Hole Size	Length Thru Bore	Ball Diameter	Price
B241	1	Top Link Ball; Replaces J-D F2680 & Oliver 105968A	3/4"	1-3/4"	2"	\$7.85
B242	2	Top Link Ball; Replaces J-D F2681 & Oliver 104585A	1"	1-3/4"	2"	7.85
B243	1	Lift Arm Ball; Fits Ford 3000, 4000 & 5000 Replaces Ford DDN995233	7/8"	1-3/8"	2-1/4"	7.85
B244	2	Lift Arm Ball; Fits Ford 3000, 4000 & 5000 Replaces Ford C5NN571	1-1/8"	1-3/4"	2-1/4"	8.29
B246	2	Lift Arm Ball; Replaces Oliver 104591A Fits all models with claw type lift arm	1-1/8"	1-3/4"	2"	7.85

NEW PRICES AS OF 4/10/2021

## DRAWBARS

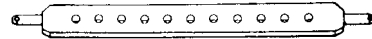

No.	Category	Lift Spacing	No. Of Holes	Hole Diam.	Pin Diam.	Thickness	Width	Price
DB418	0	20"	7	5/8"	5/8"	5/8"	2"	\$31.04
DB411	1	26"	11	3/4"	7/8"	1"	2-1/2"	44.88
DB4115	1	26"	11	3/4"	7/8"	1-1/8"	2-1/2"	62.83
DB421	2	26"	11	3/4"	1-1/8"	1-1/4"	3"	70.51
DB4212*	2	32"	13	3/4"	1-1/8"	1-1/4"	3"	100.65
DB422	2	32"	13	3/4"	1-1/8"	1-1/4"	3"	100.65
DB431	3	38"	5	1-1/4"	1-7/16"	1-3/4"	3-1/2"	223.38

\*Heat Treated

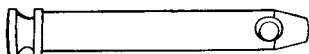

## TOP LINK PINS

No.	Category	Description	Pin Diam.	Usable Length	Overall Length	Price
P776	0	Top link pin	5/8"	3"	4-7/16"	\$2.42
P771	1	Replaces Ford 9N-560, Ferguson 195647-M1	3/4"	2-3/4"	4-1/2"	2.42
P772	1	Long top link pin; replaces Ferguson 195589-M1, A-C 39942	3/4"	3-7/8"	5-1/2"	2.88
P774	2	Replaces Ford C5NN486A	1"	4-3/8"	6"	5.26
P7711	3	Clevis top link pin	1-1/4"	4-3/8"	6-1/2"	11.22

# THREE POINT LINKAGE EQUIPMENT

P721  
P722  
P724  
P7220  
P7221



P7211  
P728  
P7240  
P7212  
P7229

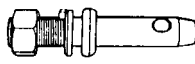

## DRAW PINS

No.	Cat.	Description	Pin Diam.	Usable Length	Overall Length	Thread Diam.	Thread Length	Price
P7220	0	Universal, adjustable	5/8"	1-5/16"	3-7/8"	5/8" NF	2"	\$3.48
P7221	0-1	Universal, adjustable	7/8"	1-3/4"	4-1/2"	5/8" NF	2"	6.01
P722	1	Universal, adjustable	7/8"	1-5/8"	5"	7/8" NF	2-5/8"	4.05
P728	1	Forged	7/8"	1-3/4"	5-1/2"	7/8" NF	1-5/8"	3.61
P724	1-2	For cat. 1 implements on cat. 2 tractors	1-1/8"	1-3/4"	5-1/4"	7/8" NF	2-7/16"	7.55
P7240	1-2	Forged; for cat. 1 implts. on cat. 2 tractors	1-1/8"	1-13/16"	5-1/4"	7/8" NF	1-5/8"	7.22
P721	2	Universal, adjustable	1-1/8"	1-3/4"	6-1/8"	1-1/8" NF	3-3/8"	10.71
P7212	2	Forged	1-1/8"	2"	6-1/8"	1-1/8" NF	2-3/8"	9.50
P7211	2-3	Universal; for cat. 2 implts. on cat. 3 tractors	1-7/16"	1-7/8"	5-3/4"	1-1/8" NF	1-1/2"	20.31
P7229	3	Forged	1-7/16"	1-7/8"	5-7/8"	1-3/8" NF	1-5/8"	22.75



## LIFT ARM BUSHINGS

No.	Category	Description	Outside Diameter	Inside Diameter	Length	Price
B828	0-1	Fits All Cat. 0 Lift Arm Pins	7/8"	5/8"	1-3/8"	\$1.80
B821	1-2	Fits All Cat. 1 Lift Arm Pins; Replaces Ford C7NN6992A	1-1/8"	7/8"	1-3/4"	1.80
B832	2-3	Fits All Cat. 2 Lift Arm Pins	1-7/16"	1-1/8"	1-3/4"	2.24
B8312	2-3	Fits All Cat. 2 Lift Arm Pins; 15/32" Lynch Pin Hole	1-7/16"	1-1/8"	2-1/2"	4.53

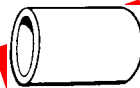

## TOP LINK BUSHINGS

No.	Category	Description	Outside Diameter	Inside Diameter	Length	Price
B829	0-1	Fits All Cat. 0 Top Link Pins	3/4"	5/8"	1-5/8"	\$1.80
B831	1-2	Fits All Cat. 1 Top Link Pins; Replaces Ford C7NN6993A	1"	3/4"	1-15/16"	1.80
B833	2-3	Fits All Cat. 2 Top Link Pins	1-1/4"	1"	1-3/4"	2.24

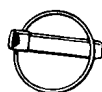

## LYNCH PINS

No.	Description	Pin Diam.	Usable Length	Shank Length	Overall Length	Price
P7919	Forged Lynch Pin	3/16"	7/8"	1-1/8"	1-1/2"	\$.48
P794	Forged Lynch Pin	1/4"	1-1/4"	1-3/4"	2-1/8"	.55
P7915	Forged Lynch Pin	5/16"	1-1/4"	1-3/4"	2-1/8"	.64
P791	Forged Lynch Pin	7/16"	1-1/4"	1-3/4"	2"	.48
P7913	Forged, Heavy-Duty; Fits Cat. 1, 2 & 3 Pins	7/16"	1-1/2"	1-3/4"	2-1/8"	1.12

DEALER SCHEDULE THIS PAGE ABOVE.....203

## SAFETY LOCK KLIK - PINS

The Danuser "Safety Lock" Klik-Pin is the ultimate in a positive quick-release lynch pin. In the closed position, the free ends of the snap ring are seated in locking grooves, making it virtually impossible for the ring to be accidentally opened and pin lost, resulting in damage to hitch assembly. Only a firm pressure on BOTH sides of the snap ring will free the ends from the locking grooves, releasing the ring to open position, and permit removal of the pin. It's truly the most positive of Quick "On And Off" Fasteners.

Fits Category 1, 2, or 3

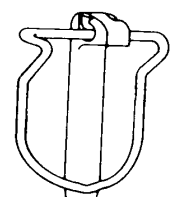

No.	Description	Price
9656-0	Safety Lock Klik-Pin	\$3.10

Dealer Schedule.....152

# THREE POINT LINKAGE EQUIPMENT

## LIFT ARMS AND LIFT ARM PARTS



LA3322

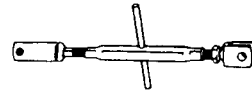

SL152

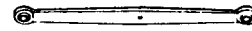

LA331

No.	Category	Description	Price
LA331	1	Right or left hand lift arm; fits Ferguson all models, Ford 2N, 8N, 9N, NAA, M-F 35, 50, Oliver 550 & 3-Pt. conversion, J-D 1010; 7/8" pin holes; 31-3/4" ball centers; 34-1/2" overall length.	\$79.40
SL152	1	Lift arm leveling assembly; 18-1/2" closed; 25" open; 7/8" NF thread dia.; replaces Ford NCA577A ...	45.67
LA3322	1	Forged universal lift arm repair end; fits both right & left hand; 7/8" pin hole; 4" overall length	22.04
LA3325	2	Forged universal lift arm repair end; fits both right & left hand; 1-1/8" pin hole; 5" overall length	28.67
LA3330	3	Forged universal lift arm repair end; fits both right & left hand; 1-7/16" pin hole; 5-1/2" overall length .	44.01

## STABILIZER ARMS, BRACKETS AND PINS

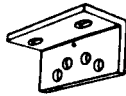

SB631

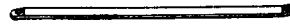

SA621



DS512

No.	Description	Price
DS511	Upper stay strap; fits all Ferguson models, Ford 2N, 8N, 9N, NAA, 600, 700, 800, 900, Oliver 550 & all 3-Pt. conversions, Massey-Ferguson 35 & 50	\$14.32
DS512	Lower stay strap; fits all Ferguson models, Ford 2N, 8N, 9N, NAA, 600, 700, 800, 900, Oliver 550 & all 3-Pt. conversions, Massey-Ferguson 35 & 50	13.40
SA621	Right or left universal stabilizer arm; 7/8" pin holes on 31-9/16" centers; fits SpeeCo SK611 kit	22.75
SA622	Right or left stabilizer arm; replaces M-F 9632358; 7/8" holes on 33-1/8" centers; fits SpeeCo SK612 kit .	24.86
SB631	Right or left universal stabilizer bracket; fits SpeeCo SK611 kit; accommodates P781 stabilizer stub pin	17.31
P711	Stabilizer stub pin fits a SpeeCo hitches and most stabilizer kits; 7/8" dia.; 3-1/4" overall length; 1/2" usable length; 7/8" NF threads	5.26
P781	Stabilizer stub pin assembled with nut and lockwasher; replaces Ford 230044, M-F 181777M1; 7/8" diam.; 2-3/8" overall length; 3/8" usable length; 5/8" NF threads	2.88

NEW PRICES AS OF 4/10/2021

## STABILIZER KITS

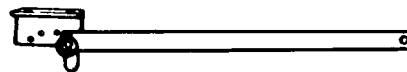

No.	Category	Description	Price
SK611	1	For cat. 1 implements with 7/8" draw pins; replaces Ferguson 677022; fits all Ferguson models, M-F 35 & 60, Ford 2N, 8N, 9N, NAA, 600, 800	\$68.50

## TURNBUCKLE & RATCHET IMPLEMENT JACKS

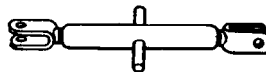

SL153

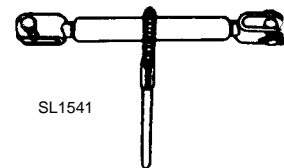

SL1541

No.	Description	Price
SL1541	Heavy-duty ratchet jack with grease zerks; adjustable from 20" to 28"; safety thread lock on ends; 1-1/4" NC threads; 1" clevis pin and handle included	\$79.53
SL153	Turnbuckle implement jack; 1" pin holes; adjustable form 20" closed to 28" open; 1-1/4" NC threads	75.22

### Ring Detent Pins



No.	Dia.	Usable Lgth.	Price
H-85602	3/16"	1-1/2"	\$2.10
H-85607	1/4"	1-1/2"	2.20
H-85610	1/4"	3"	2.35
H-85616	5/16"	1-1/2"	2.25
H-85619	5/16"	3"	2.40
H-85629	3/8"	3"	3.20
H-85631	3/8"	4"	3.25
H-85649	1/2"	3"	4.00
H-85651	1/2"	4"	4.70
H-85653	1/2"	5"	6.05

Dealer Schedule.....203

(Note: Other sizes are available. Call for details.)

### Bent Pull Pins

(Hair Pin Included)

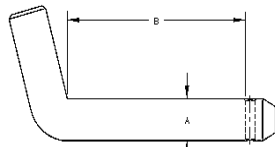

No.	Dia.	Usable Lgth.	Price
H-10303	5/16"	3"	\$2.14
H-10306	3/8"	3"	2.70
H-10312	1/2"	3"	1.90
H-10314	1/2"	4"	2.15
H-10316	1/2"	5"	2.35
H-10320	5/8"	3"	2.35
H-10322	5/8"	4"	2.65
H-10325	5/8"	5"	3.05

### Double HH (Red Top) Hitch Pins

Heat Treated

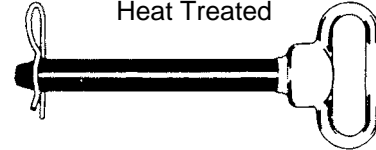

Hitch Pins designed for today's modern heavy equipment. Applicable for industrial and agricultural use. Made of high tensile steel, heat treated and stress relieved. Welded plastisol coated head and handle.

No.	Dia.	Usable Lgth.	Ctn.	Price
H-12	1/2"	3-5/8"	12	\$5.05
H-58	5/8"	5-1/2"	12	5.70
H-34	3/4"	6-1/4"	12	6.65
H-78	7/8"	6-1/2"	12	8.10
H-100	1"	7-1/2"	12	10.90
H-100-12	1"	12"	6	26.75
H-1125	1-1/8"	8-1/2"	6	15.05
H-1125-12	1-1/8"	12"	6	32.30
H-1250	1-1/4"	8-1/2"	6	19.05
H-1250-12	1-1/4"	12"	6	34.00
H-1500	1-1/2"	8-1/2"	6	26.75
H-1500-13	1-1/2"	13"	4	48.95
H-1750	1-3/4"	8-1/2"	1	63.15
H-1750-13	1-3/4"	13"	1	81.20
H-2000	2"	8-1/2"	1	73.20
H-2000-13	2"	13"	1	91.40

Dealer Schedule: Full Cartons ..... 33/133  
Broken Cartons ..... 203

### Miller Safety Hitch Pins

Pin-Lok



No.	Dia.	Usable Lgth.	Price
58H	5/8"	4-1/2"	\$5.40
34H	3/4"	4-1/2"	6.80
78H	7/8"	4-1/2"	8.00
100H	1"	4-1/2"	10.20
586H	5/8"	6"	6.00
346H	3/4"	6"	7.75
786H	7/8"	6"	9.75
1006H	1"	6"	12.50

Dealer Schedule.....33/133

### MILLER SNAP LOCK PINS

For All PTO Powered Equipment  
Zinc Plated -- Prevent Rust  
Drop in the pin and lock it.

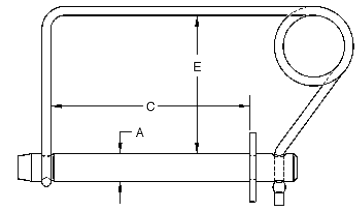

No.	A Dia.	C Usable Lgth.	E	Price
12SL	1/2"	3-1/2"	2-1/2"	\$6.05
58SL	5/8"	4"	3-3/8"	7.65
34SL	3/4"	4"	3-5/16"	8.50
346SL	3/4"	6"	3-5/16"	10.25
78SL	7/8"	5-1/2"	3-5/16"	13.05
100SL	1"	5-1/2"	3-1/4"	17.00

Dealer Schedule.....33/133

## LOCKEASE

SAFETY HITCH PIN

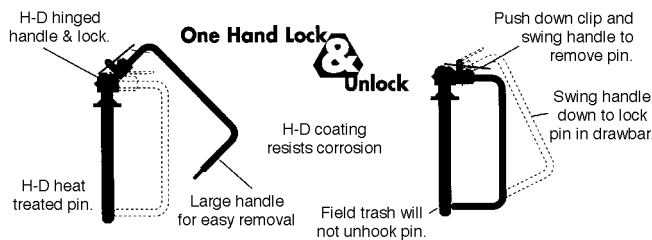

Spring loaded locking pin eliminates loss of hairpin.

Made from 1045 case hardened steel

Order No.	Size	Wt.	Pkg.	List
H-80160	3/4" x 6"	2.4#	4	\$29.40
H-80170	7/8" x 6"	2.9#	4	31.00
H-80180	1" x 6"	3.4#	4	34.75
H-80190	1-1/8" x 7"	4.1#	4	40.10
H-80200	1-1/4" x 7"	5.4#	4	43.80
H-80210	1-1/2" x 8"	6.9#	2	50.25
H-80005	Latch Repair Kit			7.80

Dealer Schedule: Full Pkg...152 & 350, Broken Pkg. & Kit...152

### MILLER LOCK PINS

"LP" Style

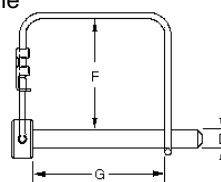

"LPR" Style

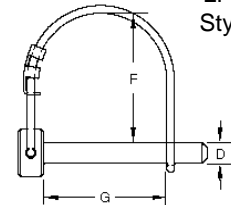

No.	D Dia.	G Usable Lgth.	F	Price
14-22LP	1/4"	2-1/2"	1-3/4"	\$1.70
516-22LP	5/16"	2-1/2"	1-11/16"	1.65
516-22LPR	5/16"	2-1/2"	1-11/16"	1.65
38-22LP	3/8"	2-1/2"	1-5/8"	1.70

Dealer Schedule.....33/133



**CLEVISES**

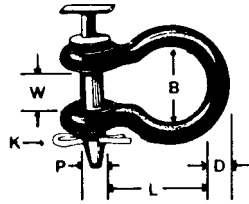

Hot forged from Hi-Strength steel: extra large shackle type eyes. Heat treated, bright zinc plated pins with hairpin lock. Will hold their shape: a size to fit all tractors

No.	D	P	W	L	B	Price Each
M8134	3/4"	5/8"	1-5/16"	3-3/4"	2-1/4"	\$14.70
M8878	7/8"	3/4"	1-5/16"	3-1/4"	2"	18.65
M8178	7/8"	3/4"	1-5/16"	4-1/4"	2-3/4"	20.50
M8190	15/16"	7/8"	1-7/16"	4-5/8"	3-1/8"	28.65
M8195	1"	1"	2-1/8"	5-5/16"	3-1/4"	32.06

Dealer Schedule .....33/133

**PINS FOR M8000 SERIES CLEVISES**

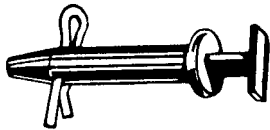

No.	Fits Clevis Number	Each
M813	M8134, M8234	\$12.26
M817	M8178, M8278, M8078, M8878	9.78
M819	M8190, M8290	11.63
M829	M8195, M8295	13.15

Dealer Schedule .....33/133

**ALL-PURPOSE CLEVIS**

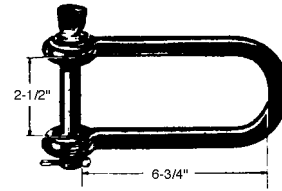

Hot forged: loose pin type with 3/4" body and pin.

No.	Each
M465	All Purpose Clevis ..... \$23.09

Dealer Schedule .....33/133

**TWIST CLEVIS**

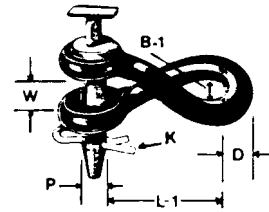

No.	D Inch	P Inch	W Inch	L Inch	Price Each
M8234	3/4"	5/8"	1-5/16"	3-3/4"	\$15.44
M8078	7/8"	3/4"	1-5/16"	3-1/4"	20.00
M8278	7/8"	3/4"	1-5/16"	4-1/4"	21.05
M8290	15/16"	7/8"	1-7/16"	4-5/8"	28.65
M8295	1"	1"	2-1/8"	5-5/16"	33.12

Dealer Schedule .....33/133

**Double HH KWIC-TWIST CLIP**

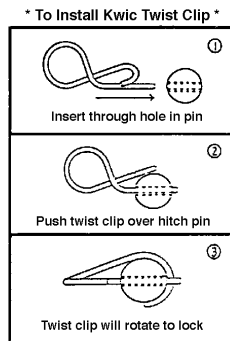
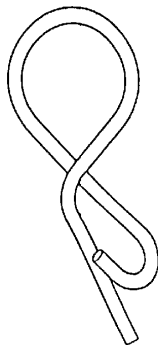

Easy to install and remove in large pins - Put an end to clip loss with hairpin clips - Made from galvanized spring steel wire - Self locking... No more lost pins - Safer to use - Made in U.S.A.

No.	Description	Each
63910	For Pin Diameter 1/4" thru 3/8"	\$ .70
63920	For Pin Diameter 1/2" thru 5/8"	.80
63930	For Pin Diameter 3/4" thru 1"	.80
63940	For Pin Diameter 1-1/16" thru 1-1/4"	1.20
63990	Display (8"x12"x2" with Header Card) 50 - 63910, 63920, 63930, 25 - 63940	107.53

Dealer Schedule.....105

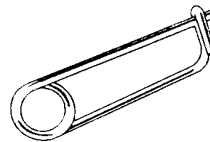

**Double HH Safety Clips**  
Stainless Steel

**Safety Clips** snap securely, made of stainless steel. Won't pull out from corn stalks on hitch pins. Won't fall out of farrowing crates. Perfect for anything that needs to be secured.

No.	Dia.	Usable Lgth.	Ctn.	Price
H-10190	5/32"	3"	24	\$1.88

Dealer Schedule: Full Cartons ..... 33/133  
Broken Cartons ..... 203

Visit our Web Site:  
[www.centralsupplyandrubber.com](http://www.centralsupplyandrubber.com)

ALL PRICES SUBJECT TO CHANGE WITHOUT NOTICE

**NEW PRICES AS OF 12/10/2020**

**MID-LINKS**

Zinc Plated

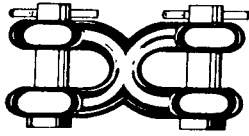

For Repairing Or Joining Log Chains

Hot forged, heat treated and tempered with heat treated pins. For use on all Hi-Test, Proof Coil and BBB chain.

No.	Chain Size	Each
M605	1/4" or 5/16"	\$7.00
M606	3/8"	8.21
M608	7/16" or 1/2"	16.81
M610	5/8"	22.17

**Tractor Drawbar Grab Hook**

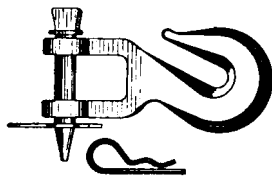

Hot forged, heat treated, positions chain on drawbar. Fits drawbars up to 1-1/8 inch thick. Use with chain 1/4 to 7/16 inch.

No.	Each
M834	\$18.50

**UTILITY CLEVIS**

Loose Pin

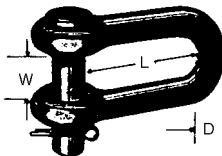

No.	D	Pin Diam.	W	L	Price Each
M1546	1/4"	5/16"	15/32"	7/8"	\$3.28
M1547	5/16"	3/8"	17/32"	1"	3.73
M1548	3/8"	7/16"	21/32"	1-1/4"	4.27
M1549	7/16"	1/2"	23/32"	1-1/2"	4.74
M1550	1/2"	5/8"	13/16"	1-11/16"	5.68
M1551	5/8"	3/4"	1-1/16"	2"	8.76

**Big Orange DRAWBAR PINS**

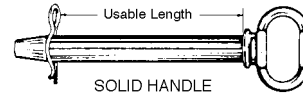

No.	Diam.	Usable Lgth.	Price Each
M1195	1/2"	3-1/2"	\$10.80
M1200	5/8"	3-3/4"	11.30

**SCREW PIN CLEVIS**

Shackle Type



**NEW PRICES AS OF 12/10/2020**

No.	D	Pin Diam.	W	L	Each
M1646	1/4"	5/16"	15/32"	1-1/8"	\$3.90
M1647	5/16"	3/8"	17/32"	1-1/4"	4.30
M1648	3/8"	7/16"	21/32"	1-7/16"	5.20
M1649	7/16"	1/2"	23/32"	1-11/16"	5.90
M1650	1/2"	5/8"	13/16"	1-15/16"	7.35
M1651	5/8"	3/4"	1-1/16"	2-1/2"	11.30
M1652	3/4"	7/8"	1-1/4"	3"	18.15
M1653	7/8"	1"	1-7/16"	3-1/4"	21.57
M1654	1"	1-1/8"	1-11/16"	3-3/4"	48.50
M1655	1-1/8"	1-1/4"	1-13/16"	4-1/4"	96.01
M1656	1-1/4"	1-3/8"	2"	4-1/2"	100.05

DEALER SCHEDULE THIS PAGE.....33/133

ALL PRICES SUBJECT TO CHANGE WITHOUT NOTICE

**Centralize  
With  
Central Supply!  
1-800-444-8666**

Visit our Web Site:  
[www.centralsupplyandrubber.com](http://www.centralsupplyandrubber.com)



# SWIVEL JACKS

Swivel Jacks are manufactured from square tubing. Top and side wind models are available with tube mount, weld-on, and bolt-on mounting brackets. Jacks are furnished complete with mounting brackets as shown.

**Made in the U.S.A.**

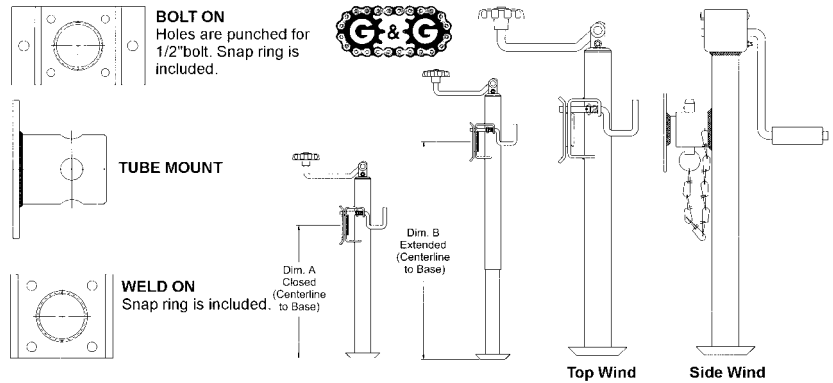

Order No.	Handle	Capacity	Lift	Distance Centerline To Base		Mounting	Price
				A. Min.	B. Max.		
450ST210	Side Wind	2000 lbs.	10"	11-7/16"	21-7/16"	Tube Mount	\$148.92
450ST215	Side Wind	2000 lbs.	15"	14-13/16"	29-13/16"	Tube Mount	157.40
450SW210	Side Wind	2000 lbs.	10"	11-7/16"	21-7/16"	Weld On	123.56
450TT210	Top Wind	2000 lbs.	10"	11-7/16"	21-7/16"	Tube Mount	126.80
450TT215	Top Wind	2000 lbs.	15"	14-13/16"	29-13/16"	Tube Mount	135.46
450TW210	Top Wind	2000 lbs.	10"	11-7/16"	21-7/16"	Weld On	101.50
450TW215	Top Wind	2000 lbs.	15"	14-13/16"	29-13/16"	Weld On	110.17
451-0515	Side Wind	5000 lbs.	15"	14-13/16"	29-13/16"	Tube Mount	180.40
456-0510	Top Wind	5000 lbs.	10"	11-7/16"	21-7/16"	Tube Mount	148.75
456-0515	Top Wind	5000 lbs.	15"	14-13/16"	29-13/16"	Tube Mount	160.40
457-0510	Top Wind	5000 lbs.	10"	11-7/16"	21-7/16"	Weld On	141.40

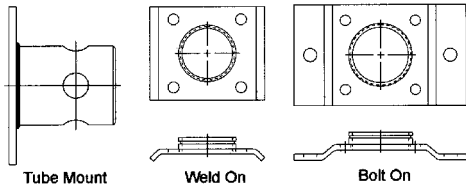

### Mounting Brackets

### Crank Replacement Kits

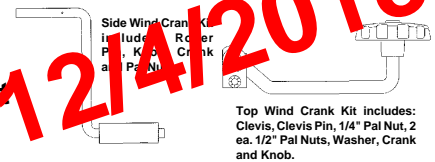

Order No.	Mounting	Capacity	Price
460AS011	Tube Mount		\$17.10
460U9218	Weld On	2000 lbs.	14.25
460W9218	Weld On	5000 lbs.	14.25
460B9218	Bolt On	2000 lbs.	15.73
46059218	Bolt On	5000 lbs.	15.73
460A9218	Snap Ring	2000 lbs.	2.44
460C9218	Snap Ring	5000 lbs.	2.44

Order No.	Capacity	Type	Price
48012201	2000 lbs.	Side Wind	\$16.18
48012501	5000 lbs.	Side Wind	16.80
48567201	2000 lbs.	Top Wind	27.99
48567501	5000 lbs.	Top Wind	30.60

### Tube Mount Locking Pin Kit

Order No.	Kit Includes	Price
48140200	Pin & Ring, Chain & Cotter Pin	\$38.61

### Screw Replacement Kits



Order No.	Capacity	Type	Lift	Price
48012210	2000 lbs.	Side Wind	10"	\$40.49
48012215	2000 lbs.	Side Wind	15"	44.28
48012510	5000 lbs.	Side Wind	10"	42.48
48012515	5000 lbs.	Side Wind	15"	44.70
48567210	2000 lbs.	Top Wind	10"	40.49
48567215	2000 lbs.	Top Wind	15"	44.28
48567510	5000 lbs.	Top Wind	10"	42.48
48567515	5000 lbs.	Top Wind	15"	44.70

### Bevel Gear Kit

Fits 2000 & 5000 lb. Jacks

Order No.	Kit Includes	Price
48012200	2 Gears & 2 Roller Pins	\$23.35



### Side Wind Crank Bearing Kit

Order No.	Kit Includes	Price
48012202	2 Bronze Bearings, fits 2000 & 5000 lb.	\$13.14



# BULLDOG JACKS

## TOUGH and TRUSTED

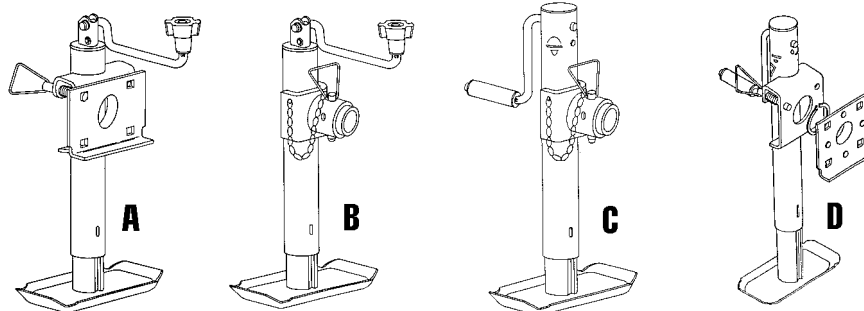

### ALL BULLDOG JACKS COME COMPLETE WITH MOUNTING

Order No.	Wind	Capacity	Travel	Distance From Mtg. to Foot		Illustration	Price
				Min.	Max.		
BD-SWS151DS	Side	2000	10"	11-1/4"	21-1/4"	D	\$81.20
BD-SWS158DTSF	Side	2000	10"	11-1/4"	21-1/4"	C	91.12
BD-SWL158DTSF	Side	2000	15"	14-1/2"	29-1/2"	C	116.27
BD-SWL178DTSF	Side	5000	15"	14-1/2"	29-1/2"	C	100.22
BD-TWS151DS	Top	2000	10"	11-1/4"	21-1/4"	A	62.90
BD-TWL151DS	Top	2000	15"	14-1/2"	29-1/2"	A	76.18
BD-TWS158DTSF	Top	2000	10"	11-1/4"	21-1/4"	B	69.41
BD-TWL158DTSF	Top	2000	15"	14-1/2"	29-1/2"	B	85.17
BD-TWS171DS	Top	5000	10"	11-1/4"	21-1/4"	A	79.97
BD-TWS178DTSF	Top	5000	10"	11-1/4"	21-1/4"	B	81.82
BD-TWL178DTSF	Top	5000	15"	14-1/2"	29-1/2"	B	98.38

### BULLDOG JACK REPAIR PARTS

Order No.	Description	Price
BD-500239	Weld-On Pivot Tube For Type B Jack	\$9.31
BD-500223	Bearing Kit f/5000# Jack	12.00
BD-500251	Bearing Kit f/2000# Jack	8.12
BD-015459	Flanged Bushing	.86
BD-015500	Black Tube Cap	4.23
BD-015904	Swivel Retaining Ring for 151DS & 171DS	3.22
BD-015909	Swivel Bracket (L Bend)	19.90
BD-018400	1/2" Plunger Ass'y for 151DS & 171DS	10.15
BD-018403	Pin, 9/16" w/Chain Ass'y f/DTSF Jack	8.35
BD-018917	TW Crank Assembly Complete	13.05
BD-500256	SW Crank & Gear Kit	20.07

Dealer Schedule Bulldog Jacks & Parts.....152

## SHOCK HITCH

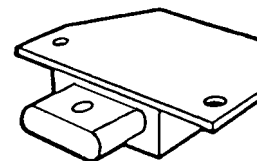

3/4" Bolt & Pin Holes, Mounting Holes Are 8" C-C.

Three springs protect clutches, transmissions, driver's back and neck, traileed equipment, trailer contents and bumpers. Provides a spring loaded cushion for liquid feed trailers, boat trailers, farm wagons, live stock trailers, farm equipment and hay balers.

Hitches must be in accordance with the specifications listed.  
 Absorbed Force ..... 4000 lbs.  
 Rod Travel ..... 1 inch  
 Rolling Load Capacity ..... 60,000 lbs.  
 Maximum Tongue Weight ..... 1500 lbs.

No.	Description	Each
SH28	Shock Hitch (Springs NOT Replaceable)	\$79.10

Dealer Schedule.....152

*Centralize With Central*

**CALL TOLL-FREE 1-800-444-8666**

## GOLDEN ROD WINCHES

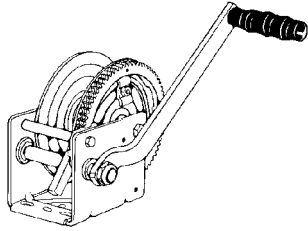

### SPECIAL FEATURES

Reinforced triple-arc-welded reels. Hardened high carbon steel intermediate and primary drive gears.  
 Load matched gear ratios for easier cranking. Hunting tooth gear system for more even wear and longer life.  
 Permanently lubricated bearings on all drive shafts.  
 Embossed, reinforced base mounting BIA specifications.  
 Standard milled-edge steel handle with corrugated grip.  
**Models DL1402 & DL1602** have two-way ratchet with off positions. Single Gear Ratio.  
**Models DL2000A & DL2500A** have 2-speed operation.

### NOT FOR MOVEMENT OF HUMAN BEINGS

No.	Ratio	Cap.	Cable Capacity	Price
DL1300	4.5:1	1300	150' of 1/8" ..... 30' of 5/16"	\$75.90
DL1402	4.5:1	1400	90' of 3/16" ..... 25' of 3/8"	84.70
DL1602	5.5:1	1600	25' of 3/8" ..... 25' of 3/8"	102.50
DL2000A	12.4:1 / 5.4:1	2000	47' of 5/16" ..... 47' of 5/16"	198.60
DL2500A	17.3:1 / 5.4:1	2500	47' of 5/16" ..... 47' of 5/16"	230.40

Dealer Schedule.....304

## Wheel Spinners



All weather-proof knob. Available in standard aluminum or powder coated colors. Heavy 3/8" post. Ball bearings. Case hardened, welded construction. Fits Regular & Deep Spoke.

No.	Description	Price
DWS-A	Wheel Spinner, Std. Aluminum	\$10.95
DWS-BK	Wheel Spinner, Black Coated	11.45
DWS-BL	Wheel Spinner, Blue Coated	11.45
DWS-G	Wheel Spinner, Green Coated	11.45
DWS-R	Wheel Spinner, Red Coated	11.45
DWS-Y	Wheel Spinner, Yellow Coated	11.45

Dealer Schedule: 12 or More Assorted ..... 203  
 Less than 12 ..... 152

**You Can Rely On  
 Central Supply!  
 For Fast Shipment Of Your Order!**

## Hi-Lift & Ag. Equipment JACKS

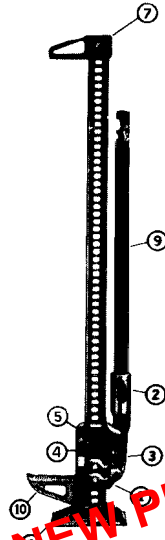

Weights only 25 lbs.  
 yet lifts, pulls or pushes 7,000 lbs.  
 Popular model 48 inch high  
 with 38 inch continuous lift.  
 Shear pin breaks when overloaded to  
 protect the lifting nose from breaking.  
 Low pick-up with a lifting nose  
 only 4" from bottom of base plate.  
 Hole beneath lifting nose  
 for use with clevis.  
 Steel Standard may be reversed  
 for extra long wear.  
 Adjustable top clamp clevis.

**#EJ-550 Equipment Jack Features:**  
 Tubular mount w/ 11 or 90° lock positions.  
 Swings out and away when not in use.  
 Mounting Tubes included with jack.  
 30" high with 18" continuous lift.  
 3.5 ton front, and 1 ton side lift capacity.

No.	Description	Price
HL-48	Hi-Lift Jack (3.5 Ton Capacity)	\$108.00
EJ-550	Hi-Lift Equipment Jack	111.60
EJ-80	Swivel Bracket f/#EJ-550 Jack	19.40

### HL-48 REPAIR PARTS

No.	Ref.	Description	Price
HL-C1	1	Small Runner (Less pin & spring)	\$25.80
HL-C2	2	Handle Socket	25.80
HL-C3	3	Pitman	19.60
HL-C4	4	Reversing Latch	16.90
HL-C5-27A	5	Reversing Switch	16.90
HL-C6-24	6	Base Plate	23.80
HL-C7	7	Top Plate-Clamp	19.60
HL-15-25	9	Steel Handle	15.95
HL-C10	10	Large Runner	34.75
HL-KIT1		Fix-It Kit (2 ea. of: Climbing Pin, Spring and Cross Pin)	23.50
HL-CP3		Climbing Pin Spring	3.10
HL-CP-11CL		Jack Climbing Pin Only	7.75
HL-CP-11CR		Jack Cross Pin Only	3.20
HL-PP-30		Pitman Pin	2.75
HL-SP-18A-19		Shear Pin Bolt	3.15
HL-RS-27A		Reversing Switch Spring	3.35
HL-B-48		Steel Standard, 48 inch	29.50

Dealer Schedule.....152

## HOT FORGED HITCH BALLS

### ONE PIECE - CHROME PLATED

Hot Forged hitch balls are drop forged from one piece of red hot steel for super strength. Each is manufactured to the Society of Automotive Engineers' Specification SAE J684F and meets or exceeds Vehicle Equipment Safety Commission regulations.

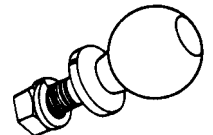

No.	Rating	Max. Load Lbs.	Ball Size	Thread Size	Stud Lgth.	Price
05101	I	2,000	1-7/8"	3/4"	1-3/4"	\$15.46
05201	II	2,000	2"	3/4"	1-3/4"	16.09
05301	III	5,000	2"	1"	2-1/8"	16.40
05501	IV	7,500	2-5/16"	1-1/4"	2-1/8"	26.50

Dealer Schedule.....152

# Milwaukee

## Heavy-Duty Sawzall Blades (Sold In Full Packages Only)



Order No.	Teeth Per In.	Lgth.	Pkg. Qty.	Cutting Rec.	Price Per Pkg.
<b>Metal Cutting</b> (High Speed Steel)					
48-00-1172	14	4"	10	B	\$27.75
48-00-1176*	24	4"	10	D	27.75
<b>Bi-Metal</b> (High speed steel teeth welded to a flexible alloy back)					
48-00-1183*	18	4"	10	G	25.80
48-00-1184*	18	6"	10	G	35.35

\* Some varieties of stainless steel can be cut with these blades.

### Cutting Recommendations:

**B**-Metal heavier than 1/8" thick, angles, bar stock, hard rubber and fiber.

**D**-Metals lighter than 18 gauge sheet, trim and tubing.

**G**-Heavy gauge metals, cast iron, angles, hard rubber, pipe, conduit, tubing, bar stock, 18 gauge to 1/8" thick and above.

Dealer Schedule.....102

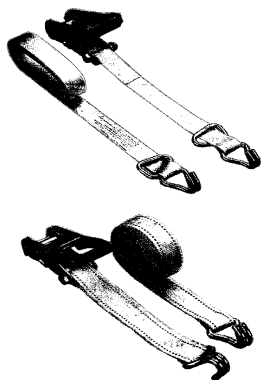

## RATCHET TIE-DOWNS

Ideal for securing all types of cargo. Tough polyester webbing with Flat or "J" Style hooks.

**Not for overhead lifting.**

Order No.	Size	Hook	Breaking Strength	Wt.	Price Each
RTD-J2415-05	1-1/2"x15'	"J"	5000#	3#	\$33.82
RTD-J3227-10	2"x27'	"J"	10000#	7#	44.79
RTD-F3227-10	2"x27'	Flat	10000#	7#	48.98

Dealer Schedule.....152

## RUBBER HOLD DOWN STRAPS (with "S" Hooks)



No.	Description	Each
HD-09	9" Hold Down Strap	\$ .99
HD-15	15" Hold Down Strap	1.17
HD-21	21" Hold Down Strap	1.32
HD-31	31" Hold Down Strap	1.69
HD-41	41" Hold Down Strap	2.48
HD-24ADJ	Adjustable Hold Down Strap 24"	1.69

### Dealer Schedule:

Full Package of 10....152 & 05 Broken Package....152

## Blue Poly Tarps

Rope reinforced hem. Sun and fade proof. Leak proof. Double durable stitching. Tear proof. Heat sealed seams. Rot proof. Rust proof grommets every 3 feet.

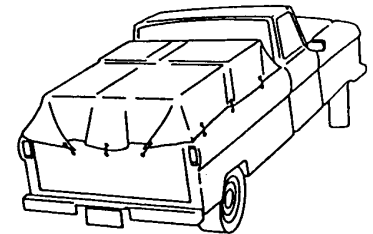

Order No	Size	Price
PT-0608	6' x 8'	\$4.00
PT-0810	8' x 10'	6.30
PT-1012	10' x 12'	9.50
PT-1014	10' x 14'	12.40
PT-1016	10' x 16'	12.70
PT-1020	10' x 20'	15.65
PT-1214	12' x 14'	13.20
PT-1216	12' x 16'	15.25
PT-1220	12' x 20'	19.05
PT-1620	16' x 20'	25.45
PT-2020	20' x 20'	31.80
PT-2030	20' x 30'	62.00
PT-2040	20' x 40'	85.00

Note - - - Other Sizes available, phone for prices.

Note - - - Finished size slightly smaller than cut size.

Dealer Schedule.....152

**Centralize**  
with Central Supply!

**Call Toll-Free 1-800-444-8666**

### SANDVIK Power Saw Blades

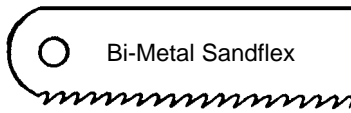

The cutting edge is manufactured from selected high speed steel and welded to a tough resilient alloy back. Unusual strength and impact resistance make this blade highly shatter-resistant. An excellent production blade for all applications.

Order No.	Length	Teeth Per In.	Width	Thick.	Each
TT-01620	12"	14	1"	.050"	\$13.30
TT-01628	14"	14	1"	.050"	14.94

Dealer Schedule: Bundle Of 10 ..... 203  
Broken Bundle ..... 102

### SANDVIK Hand Hack Saw Blades

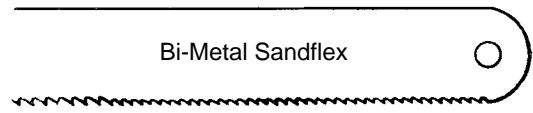

Flexible Rezipor Blades feature a high speed steel cutting edge and tough pliable back making them virtually indestructible.

Order No.	Length	Teeth Per In.	Width	Thick.	Each
TT-00106	10"	18	1/2"	.025"	\$2.30
TT-00108	10"	24	1/2"	.025"	2.30
TT-00114	12"	18	1/2"	.025"	2.30
TT-00116	12"	24	1/2"	.025"	2.30
TT-00118	12"	32	1/2"	.025"	2.30

Dealer Schedule: Bundle Of 10 ..... 152  
Broken Bundle ..... 102

NEW PRICES AS OF 1/21/2017

## "JACK" Combination Saw

### Hacksaw Wood Saw Blade!

The hard point wood cutting blade can be used in the garden or woods.

No.	Description	Price
JS-18HP-300	..... Replacement Wood Blade.....	\$3.49

Dealer Schedule.....33/133

Centralize  
with Central Supply!  
Order Online at:  
[CentralSupplyandRubber.com](http://CentralSupplyandRubber.com)

### Retractable Utility Knife



Includes one standard utility knife blade. Heavy duty metal case. Rubberized ergonomic grip.

Order No.	Price
GN-80036 .... Utility Knife (Retractable) .....	\$4.69
GN-11C ..... Replacement Blades (5 per pkg.) .....	2.05

Dealer Schedule.....152

### HACK SAW FRAMES

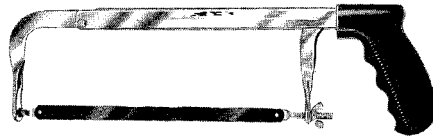

No. GN-50 Economy frames are adjustable to accommodate blades from 10" to 12" long. Depth of cut 3-1/8". Can be adjusted to cut four different angles. 9/16" x 5/32" stock.

No.	Description	Price
GN-50 .....	Economy Hacksaw Frame .....	\$8.85

Note - - All frames are furnished with blade.

Dealer Schedule.....152

Call Toll-Free: 1-800-444-8666 or Call: (402) 341-6977

# SANDVIK HIGH HARD Hard Back Carbon Band Saw Blades For Easy Cutting Of Unalloyed Steel

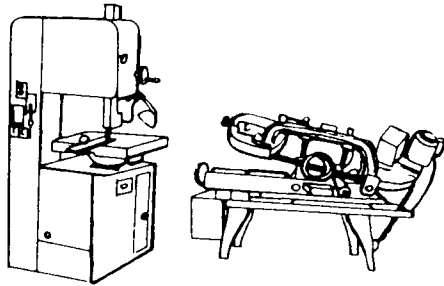

Order No.	Legth	Width	Per In.	Fits Saw	Set	Each
TT44-010	3' 8-7/8"	1/2"	14	Portables	R	\$18.72
TT44-020	5'	1/2"	14	Wells 49A & 300	R	20.60
TT44-030	5' 4-1/2"	1/2"	14	Emerson 10-1466	R	20.65
TT44-040	6' 9"	1/2"	14	Tester	R	22.50
TT44-050	7' 5"	1/2"	14	Johnson B	R	23.10
TT44-060	7' 5"	5/8"	14	Johnson B	R	23.10
TT44-070	7' 9"	1/2"	14	Wells B, Rockwell 28-300	W	23.75
TT44-080	7' 11-1/2"	5/8"	14	Rockwell 20-900	R	29.00
TT44-100	8' 10"	3/4"	14	Brule, Olson	R	29.00
TT44-110	8' 11"	5/8"	14	Emerson 10-2721	R	29.00
TT44-120	8' 11"	3/4"	14	Emerson 10-2721	W	26.27
TT44-130	9' 7"	3/4"	14	Carolina HD9	W	30.50
TT44-140	9' 8"	3/4"	14	Carolina HD10	W	30.50
TT44-150	9' 9"	3/4"	14	Olson	R	30.50
TT44-160	10' 5"	3/4"	14	Kalamazoo 816	W	31.50
TT44-170	10' 9"	3/4"	14	Rockwell 20-916	W	31.50
TT44-175	10' 10-1/2"	3/4"	10	Kalamazoo 8C	W	31.90
TT44-180	10' 10-1/2"	3/4"	14	Kalamazoo 8C	W	31.90
TT44-185	11' 5"	3/4"	10	Johnson J	W	32.75
TT44-190	11' 5"	3/4"	14	Johnson J	W	32.75
TT44-200	11' 6"	3/4"	14	Wells 8	W	32.75
TT44-210	11' 6"	3/4"	18	Wells 8	W	32.75

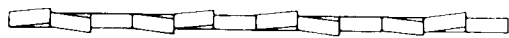

**Raker Set:** consists of one tooth tilted to the right, the next tooth tilted left, and the third tooth straight. Raker set is preferred for cutting solid cross sections, uniform in shape. It is also used for contour or profile cutting applications

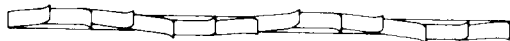

**Wavy Set:** consists of groups of teeth set to the left and to the right, alternating throughout the blade. Wavy set provides greater chip clearance and helps eliminate tooth strippage. It is recommended for most general purpose horizontal band machines.

Used on machines that are properly maintained these blades will give excellent service. Blades are guaranteed when used on "wet-cut" saws with coolant system in operation. Further warranty of service is not intended or inferred.

Dealer Schedule: Full Carton of 10.....203 Broken Carton.....151

## "NEW" RAPID TAP Hard Metal Cutting Fluid

No Ozone Depleting Substances



Effective on beryllium, copper, brass, bronze, cast iron, magnesium, stainless steel, stellite, titanium and others  
**NOT FOR USE ON PLASTIC**

A drop or two makes tapping, reaming, drilling, threading and all other precision machining easier, faster and more accurate.

Breaks down surface tensions and adhesions resulting from tool operation.

Frees the tool, reducing tool wear, part rejections and breakage.

	Case	Each
RTCT-4	Rapid Tap, 4 oz.	24 \$3.66
RTCT-PT	Rapid Tap, pint	12 11.67
RTCT-GAL	Rapid Tap, gallon	4 65.85
RTCT-Paste	Rapid Tap Paste, 8 oz. Jar	12 11.67

Dealer Schedule: Full Case ..... 152  
Broken Case ..... 151

## "SUPERKUT" Dark Cutting Oil

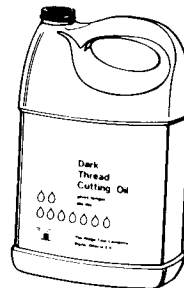

SuperKut Cutting Oil is a multi-purpose machining and grinding oil for ferrous metals. It has a balanced combination of additives and oil that offers excellent tool life and surface finishes on a wide variety of steels and stainless steels. The excellent lubricity and extreme pressure characteristics help cool the tools and work piece.

SuperKut cutting oil is recommended for threading and tapping machines, automatic screw machines, CNC operations and most other shop operations where a dark colored, active sulfur cutting oil is required.

	Each
TK-1D	SuperKut Cutting Oil (1 Gallon) ..... \$38.28

Dealer Schedule: Full Case of 6 ..... 152  
Broken Case ..... 151

PRICES ARE SUBJECT TO CHANGE WITHOUT NOTICE.

NEW PRICES AS OF 2/28/2020





**SPRAY-ON CUTTING OIL**

Speeds up cutting, sawing, threading, drilling and tapping. Clings to curved or beveled surfaces, will not run off or break down.

**Applications**

Metalworking operations in stainless steel, aluminum, brass and copper. Also works on turret lathe, gear cutters, broaches and automatic screw machines.

**NEW PRICES AS OF 3/1/2019**

No.	Each
00208 ..... Cutting Oil 12 oz. ....	\$9.07

Dealer Schedule: Full Case of 12 ..... 253  
Broken Case ..... 102

**Central SAFETY GOGGLES**

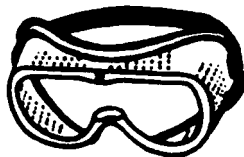

Impact resistant, flexible soft-side goggles. Vented top and sides keep cool and limit fogging. Optical quality polycarbonate lens assures clear, undistorted vision.

Order No.	Price
G-ST ..... Safety Goggles (Clear) .....	\$3.95

Dealer Schedule.....152

**CoolCare Bandanas**



Place around neck to help stay cool even on the hottest days. Lightweight cloth assures maximum evaporative cooling. Stays moist for 24-48 hours. Reusable. Hydrates in 5-10 minutes. Hand wash only.

Order No.	Description	Price
S40-0800BBP ....	CoolCare Bandana, Blue Print ...	\$4.95
S40-0800RBP ....	CoolCare Bandana, Red Print ....	4.95

Dealer Schedule: Broken Pkg....Net Pkg. of 12....104

**Vernier Caliper (SAE & Metric)**

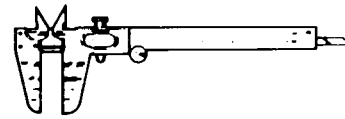

No.	Price
GH-723ME Vernier Caliper, 0 to 5" range, stainless Graduated in 16ths and MM .....	\$16.00

Dealer Schedule.....102

**Pocket Slide Caliper**

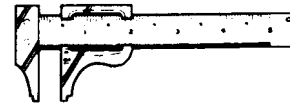

No.	Price
GH-729 ..... Pocket Slide Caliper, 0 to 4" range, stainless, graduated in 16ths & 32nds. ....	\$14.40

Dealer Schedule.....102

**Dial Caliper**



**NEW PRICES AS OF 3/23/2020**

No.	Price
GH-142 ..... Dial Caliper, 0 to 6" range, fiberglass reinforced plastic, reads .01" & 1/64" on the Dial and mm on the Bar Scale . ....	\$44.20

Dealer Schedule.....102

**Wolf-Peak Safety Glasses**

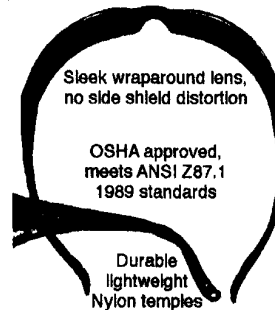

**For Safety, Style & Comfort**

99.9% protection from UVA/UVB rays  
Scratch resistant hard coat Polycarbonate

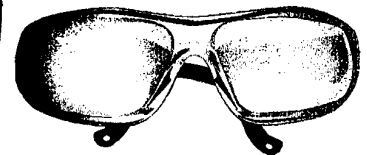

No.	Description	List
AB111 .....	Kirova Safety Glasses (Clear) .....	\$8.99
AB112 .....	Kirova Safety Glasses (Yellow) .....	8.99
AB116 .....	Kirova Safety Glasses (Smoke) .....	8.99
AB117 .....	Kirova Safety Glasses (Silver Mirror) .....	8.99
SW115 .....	Dakura Glasses (Copper driving lens) ....	17.95
SW126 .....	Dakura Glasses (Smoke) .....	17.95
SWAP119..	Dakura Glasses (Prec. Red Mirror) .....	19.99
ABDS .....	Counter Display (10 Unit, Locking) .... Net	29.50

Dealer Schedule: 1 - 11....203 12 or more....104  
Quantities May Be Assorted.

**Call Toll-Free 8-5, M-F**

**1-800-444-8666**

**Or Order On-Line**

[www.centuralsupplyandrubber.com](http://www.centuralsupplyandrubber.com)

### Straight Shank Drills

High Speed Steel (Jobbers Length)

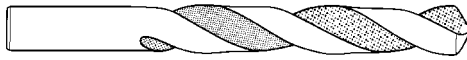

Order No.	Dia.	O.A. Lgth.	Pkg. Qty.	Price Each
CD-01030	1/16"	1-7/8"	12	\$1.10
CD-01040	5/64"	2"	12	1.10
CD-01050	3/32"	2-1/4"	12	1.10
CD-01060	7/64"	2-5/8"	12	1.12
CD-01070	1/8"	2-3/4"	12	1.20
CD-01080	9/64"	2-7/8"	12	1.35
CD-01090	5/32"	3-1/8"	12	1.40
CD-01100	11/64"	3-1/4"	12	1.57
CD-01110	3/16"	3-1/2"	12	1.77
CD-01120	13/64"	3-5/8"	12	1.96
CD-01130	7/32"	3-3/4"	12	2.17
CD-01140	15/64"	3-7/8"	12	2.32
CD-01150	1/4"	4"	12	2.60
CD-01160	17/64"	4-1/8"	12	3.22
CD-01170	9/32"	4-1/4"	12	3.60
CD-01180	19/64"	4-3/8"	6	3.93
CD-01190	5/16"	4-1/2"	6	4.00
CD-01200	21/64"	4-5/8"	6	4.44
CD-01210	11/32"	4-3/4"	6	5.13
CD-01220	23/64"	4-7/8"	6	5.69
CD-01230	3/8"	5"	6	5.85
CD-01240	25/64"	5-1/8"	6	6.53
CD-01250	13/32"	5-1/4"	6	6.71
CD-01260	27/64"	5-3/8"	6	7.30
CD-01270	7/16"	5-1/2"	6	7.97
CD-01280	29/64"	5-5/8"	6	9.22
CD-01290	15/32"	5-3/4"	6	10.00
CD-01300	31/64"	5-7/8"	6	9.80
CD-01310	1/2"	6"	6	9.91

Dealer Schedule: Full Pkg.....353  
Broken Pkg.....23/133

### Drill Case Sets

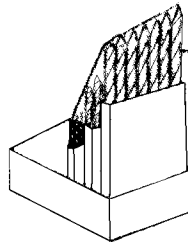

The drills fit into hinged metal panels that fold into the box like the pages of a book. Stamped on the side of the panel is an index giving size of each drill, decimal equivalent, tap size, etc.

Order No.	Description	Price
CD-42070	.. 29 pc. Drill Set, 1/16 to 1/2" by 64ths	..... \$145.80
CD-42030	.. 15 pc. Drill Set, 1/16 to 1/2" by 32nds	..... 78.71
CD-42020	.. 13 pc. Drill Set, 1/16 to 1/4" by 64ths	..... 28.45
Dealer Schedule.....		353

### Screw & Pipe Extractors



Order No.	Screw Extractor No.	Removes Screw Dia.	Pkg. Qty.	Price
CD-57100	EX-1	3/32" to 5/32"	5	\$2.51
CD-57110	EX-2	5/32" to 7/32"	5	3.15
CD-57120	EX-3	7/32" to 9/32"	5	3.00
CD-57130	EX-4	9/32" to 3/8"	5	3.25
CD-57140	EX-5	3/8" to 5/8"	5	4.32
		& 1/4" Pipe	5	

#### SCREW & PIPE EXTRACTOR SET

Order No.	Set No.	Contains Sizes	Price
CD-57210	SE-5C	1-2-3-4-5	\$17.42

Dealer Schedule.....253

### Blacksmith's Drills

High Speed Steel Shank 1/2" Diameter, 2-1/4" Long

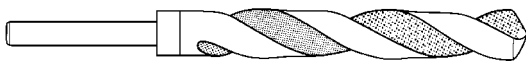

Order No.	Dia.	O.A. Lgth.	Price
CD-29130	33/64"	6"	\$25.92
CD-29140	17/32"	6"	24.68
CD-29160	9/16"	6"	25.75
CD-29180	19/32"	6"	28.20
CD-29200	5/8"	6"	28.45
CD-29220	21/32"	6"	31.15
CD-29240	11/16"	6"	31.77
CD-29260	23/32"	6"	32.90
CD-29280	3/4"	6"	34.61
CD-29300	25/32"	6"	37.55
CD-29320	13/16"	6"	38.25
CD-29360	7/8"	6"	41.32
CD-29400	15/16"	6"	46.15
CD-29440	1"	6"	53.73
CD-29450	1-1/16"	6"	70.60
CD-29460	1-1/8"	6"	77.25
CD-29490	1-1/4"	6"	90.65

Dealer Schedule.....253

### No. 825 General Drill Grinder

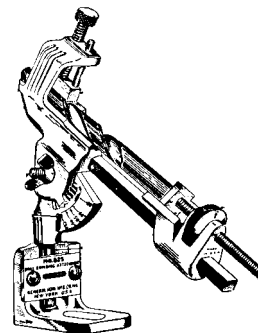

For correctly sharpening drills of the following sizes:  
From 1/8" to 3/4" - - - Fractional.  
From #1 to #30 - - - Number Size.  
From A to Z - - - Letter Size.  
From 3.0 to 19.0 - - - Millimeter.

No.	Description	Price
GH-825	..... General Drill Grinder	\$38.50
Dealer Schedule.....		102

NEW PRICES AS OF 8/14/2018

**Taps**  
**Hi-Carbon Steel**  
**U.S. Sizes**

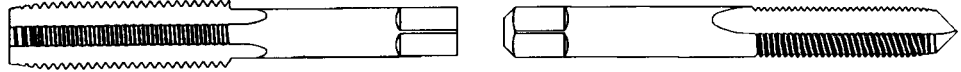
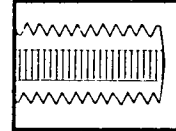
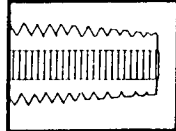
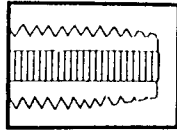

ILLUSTRATION SHOWING 3 STYLES OF TAPS



**Plug**

3 to 5 threads chamfered-general use when tapping to bottom of hole is not critical. (This is the most widely used type of tap.)

**Taper**

8 to 10 threads chamfered for easy thread starting in tough materials.

**Bottoming**

1-1/2 threads chamfered-use after threads have been started for tapping to bottom of hole

**PLUG TAPS**

Order No.	Size	Use Drill Size	Pkg. Qty.	Price Each
CD-55030	1/4"-20 NC	7	3	\$2.82
CD-55040	1/4"-28 NF	3	3	2.82
CD-55050	5/16"-18 NC	17/64	3	3.70
CD-55060	5/16"-24 NF	17/64	3	3.70
CD-55070	3/8"-16 NC	5/16	3	4.56
CD-55080	3/8"-24 NF	21/64	3	4.56
CD-55090	7/16"-14 NC	3/8	3	4.95
CD-55100	7/16"-20 NF	25/64	3	4.95
CD-55110	1/2"-13 NC	27/64	3	5.62
CD-55120	1/2"-20 NF	29/64	3	5.62
CD-55130	9/16"-12 NC	31/64	3	8.13
CD-55140	9/16"-18 NF	33/64	3	8.13
CD-55150	5/8"-11 NC	17/32	3	9.72
CD-55720	5/8"-18 NF	37/64	3	9.72
CD-55160	3/4"-10 NC	21/32	3	12.75
CD-55890	3/4"-16 NF	11/16	3	12.75
CD-55170	7/8"-9 NC	49/64	3	16.88
CD-55180	7/8"-14 NF	13/16	3	16.88
CD-55190	1"-8 NC	7/8	3	20.95
CD-55210	1"-14 NF	29/32	3	20.95

**TAPER TAPS**

Order No.	Size	Use Drill Size	Pkg. Qty.	Price Each
CD-55270	1/4"-20 NC	7	3	\$2.82
CD-55280	1/4"-28 NF	3	3	2.82
CD-55290	5/16"-18 NC	17/64	3	3.70
CD-55300	5/16"-24 NF	17/64	3	3.70
CD-55310	3/8"-16 NC	5/16	3	4.56
CD-55320	3/8"-24 NF	21/64	3	4.56
CD-55330	7/16"-14 NC	3/8	3	4.95
CD-55340	7/16"-20 NF	25/64	3	4.95
CD-55350	1/2"-13 NC	27/64	3	5.62
CD-55360	1/2"-20 NF	29/64	3	5.62
CD-55370	9/16"-12 NC	31/64	3	8.13
CD-55380	9/16"-18 NF	33/64	3	8.13
CD-55390	5/8"-11 NC	17/32	3	9.72
CD-55460	5/8"-18 NF	37/64	3	9.72
CD-55400	3/4"-10 NC	21/32	3	12.75
CD-55710	3/4"-16 NF	11/16	3	12.75
CD-55410	7/8"-9 NC	49/64	3	16.88
CD-55420	7/8"-14 NF	13/16	3	16.88
CD-55430	1"-8 NC	7/8	3	20.95
CD-55450	1"-14 NF	29/32	3	20.95

NEW PRICES AS OF 8/14/2018

**Pipe Taps**  
**Hi-Carbon Steel**



Order No.	Size	Use Drill Size	Pkg. Qty.	Price Each
CD-56910	1/8"-27 NPT	11/32	3	\$6.00
CD-56920	1/4"-18 NPT	7/16	3	7.80
CD-56930	3/8"-18 NPT	37/64	1	9.76
CD-56940	1/2"-14 NPT	23/32	1	20.60
CD-56950	3/4"-14 NPT	59/64	1	22.00
CD-56960	1x11-1/2 NPT	1-5/32	1	38.75

**BOTTOMING TAPS**

Order No.	Size	Use Drill Size	Pkg. Qty.	Price Each
CD-55520	1/4"-20 NC	7	3	\$2.82
CD-55530	1/4"-28 NF	3	3	2.82
CD-55540	5/16"-18 NC	17/64	3	3.70
CD-55550	5/16"-24 NF	17/64	3	3.70
CD-55560	3/8"-16 NC	5/16	3	4.56
CD-55570	3/8"-24 NF	21/64	3	4.56
CD-55580	7/16"-14 NC	3/8	3	4.95
CD-55590	7/16"-20 NF	25/64	3	4.95
CD-55600	1/2"-13 NC	27/64	3	5.62
CD-55610	1/2"-20 NF	29/64	3	5.62
CD-55620	9/16"-12 NC	31/64	3	8.13
CD-55630	9/16"-18 NF	33/64	3	8.13
CD-55640	5/8"-11 NC	17/32	3	9.72
CD-56040	5/8"-18 NF	37/64	3	9.72
CD-55650	3/4"-10 NC	21/32	3	12.75
CD-56070	3/4"-16 NF	11/16	3	12.75
CD-55660	7/8"-9 NC	49/64	3	16.88
CD-55670	7/8"-14 NF	13/16	3	16.88
CD-55680	1"-8 NC	7/8	3	20.95
CD-55700	1"-14 NF	29/32	3	20.95

DEALER SCHEDULE THIS PAGE.....253

*Centralize With Central*

# MAGNUM TAP & DRILL SET

THE PREMIUM CHOICE FOR MAINTAINANCE & PRODUCTION APPLICATIONS

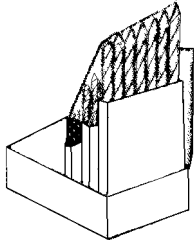

**Magnum Super Premium Drills Feature:**

Special Hi-Moly Tool Steel, Black & Gold Finish, 135° Split Point Is Self Centering, Won't Walk, Space Age Nitro-Carbuized Steel Withstands Higher Drilling Temps & Stays Sharp Longer, Recommended For Stainless & Other Hard Metals.

**Magnum Super Premium Taps Feature:**

Special Hi-Moly Tool Steel, Gold Finish, Spiral Point For Faster Cutting With Less Torque, Recommended For Stainless & Other Hard Metals.

No. List  
 CD-57580 .... Magnum Tap & Drill Set ..... \$178.15  
 Dealer Schedule.....253

Contains Drill Sizes:  
 #36, #29, #25, #21, #7, F, 5/16", U, 27/64"

Contains Tap Sizes:  
 6-32, 8-32, 10-24, 10-32, 1/4"-20,  
 5/16"-18, 3/8"-16, 7/16"-14, 1/2"-13

**MAGNUM SUPER PREMIUM TAPS**

Order No.	Size	Use Drill Size	Pkg. Qty.	Price Each
CD-60220	#6-32	#36	3	\$9.15
CD-60240	#8-32	#29	3	9.30
CD-60260	#10-24	#25	3	10.02
CD-60270	#10-32	#21	3	10.02
CD-60320	1/4"-20	#7	3	11.12
CD-60340	5/16"-18	F	3	11.88
CD-60360	3/8"-16	5/16"	3	17.42
CD-60380	7/16"-14	U	3	23.76
CD-60400	1/2"-13	27/64"	3	24.51

Dealer Schedule.....253

**MAGNUM SUPER PREMIUM DRILLS**

Order No.	Size	O.A. Lgth.	Pkg. Qty.	Price Each
CD-92260	#36	2-1/2"	12	\$1.72
CD-39220	#29	2-7/8"	12	1.89
CD-39180	#25	3"	12	2.13
CD-39140	#21	3-1/4"	12	2.25
CD-39000	#7	3-5/8"	12	3.22
CD-39510	F	4-1/8"	12	4.57
CD-05740	5/16"	4-1/2"	6	5.18
CD-39660	U	4-7/8"	6	9.26
CD-05810	27/64"	5-3/8"	6	9.15

Dealer Schedule: Full Pkg.....353  
 Broken Pkg.....23/133

NEW PRICES AS OF 8/14/2018

Order No.	Dia.	O.A. Lgth.	Pkg. Qty.	Price Each
CD-92440	1/8"	2-3/4"	6	\$6.22
CD-92450	3/16"	3-1/2"	6	8.67
CD-92460	1/4"	4"	6	12.05
CD-92470	5/16"	4-1/2"	3	18.25
CD-92480	3/8"	5"	3	28.32

Dealer Schedule: Full Pkg...353, Broken Pkg...23/133

**LEFT HAND SPIRAL DRILLS**

**MAGNUM SUPER PREMIUM - JOBBERS LENGTH**

Special **Hi-Molybdenum** tool steel. 135° split point for fast penetration and accurate starting without center punch. Precision ground point, flutes, body, clearance and drill diameter for ultimate in accuracy and performance. Body and clearance are gold surface treated for maximum lubricity. Ideal for drilling broken studs. Left hand spiral drill may loosen the bolt stud while drilling a hole for use of the screw extractor.

**Quality Contractor Hammers**



Drop forged - Polished Head  
 Fiberglass handle - Non-slip cushion grip.



Order No.	Desc.	Price
GN-CP3	Cross Pein Hammer, 3 lb.	\$24.95
GN-HBP16	Ball Pein Hammer, 16 oz.	24.76



Drop forged - Polished Head  
 Fiberglass handle - Non-slip cushion grip.



Order No.	Desc.	Price
GN-HG16C	Curved Claw Hammer, 16 oz.	\$14.69
GN-HG16S	Straight Claw Hammer, 16 oz.	14.69

Dealer Schedule.....152

NEW PRICES AS OF 12/20/2020

## Vise-Grip Locking Pliers

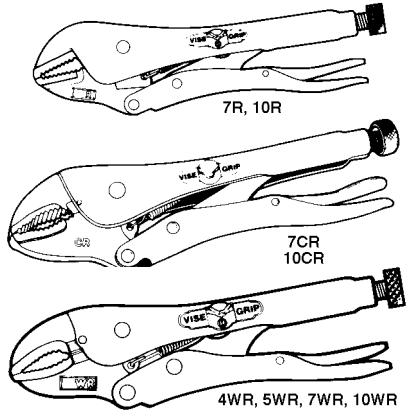

### R SERIES, STRAIGHT JAW LOCKING PLIERS

Locks instantly, release quickly and adjusts to pliers action.

### CR SERIES, CURVED JAW PLIERS

Curved jaws for better contact on bolt heads, nuts and round work. Simply turn the micro-adjusting screw to set jaws.

### WR SERIES, CURVED JAW WITH WIRE CUTTER

All have curved jaws, knurled tips and wire cutters. They lock instantly and release quickly. Also adjust to pliers action.

No.	Length	Jaw Adjustment	Jaw Thickness	Price
7R	7"	1-1/8"	7/16"	\$22.53
10R	10"	1-1/2"	5/8"	22.91
7CR	7"	1-5/8"	15/16"	22.53
10CR	10"	1-7/8"	3/8"	22.91
4WR	4"	15/16"	1/4"	15.70
5WR	5"	1-1/4"	1/4"	21.94
7WR	7"	1-5/8"	5/16"	22.53
10WR	10"	1-7/8"	3/8"	22.91

Dealer Schedule.....203



## Large Jaw Vise-Grips

Unique jaw shape of 12LC is large enough to handle most situations requiring a large wrench. Works as a pipe wrench in tight spaces. Great for removing tail pipes. Ideal for clamping odd-shaped pieces for welding.

No.	Length	Jaw Adj. At Tips	Jaw Thickness	Price
12LC	11"	3-1/8"	1/2"	\$27.73

Dealer Schedule.....203

### WISE-GRIP PARTS

No.	Description	Price
VG-92	Spring for 4LN, 4WR	\$ 2.18
VG-52	Spring for 5WR, 6LN, 6BN, 6R, 6SP	2.14
VG-22	Spring for 7R, 7CR, 7WR, 9LN, 11R, 11SP	3.19
VG-8	Spring for 10R, 10CR, 10WR, 20R, 12LC	4.15
VG-91	Adj. Screw for 4LN, 4WR	3.21
VG-51	Adj. Screw for 5WR, 6LN, 6BN, 6R, 6SP	2.97
VG-21	Adj. Screw for 7R, 7CR, 7WR, 9LN	3.32
VG-7	Adj. Screw for 10R, 10CR, 10WR, 12LC, 11R, 11SP, 18SP	5.15

Dealer Schedule.....152

## Long Nose Vise-Grips

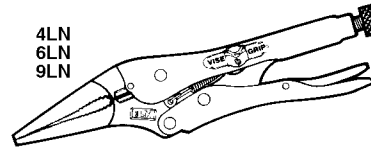

LN SERIES, Long nose jaws reach into tight spots where other tools can't. Built-in wire cutter. Adjusts easily.

No.	Length	Jaw Adj. At Tips	Jaw Thickness	Price
4LN	4"	1-3/4"	1/8" at tip	\$17.78
6LN	6"	2-1/4"	1/8" at tip	23.61
9LN	9"	3"	3/16" at tip	28.30

Dealer Schedule.....203

## WISE-GRIP Sheet Metal Clamp



Makes bending, forming, and crimping sheet metal jobs easier. Turn screw to adjust pressure and fit work. Stays adjusted for repetitive use.

Constructed of high-grade heat-treated alloy steel for maximum toughness and durability. Classic trigger release designed to provide maximum locking force. Size 8". Jaw capacity 3-1/8"

No.	Description	Price
8R	Vise-Grip Sheet Metal Clamp	\$26.66

## WISE-GRIP Locking Welding Clamp

U shaped jaws provide enhanced visibility and more working space. For use in welding applications or for holding awkward shapes in place.



Constructed of high-grade heat-treated alloy steel for maximum toughness and durability. Size 8". Jaw capacity 1-5/8". Jaw depth 1-3/4"

No.	Description	Price
9R	Vise-Grip Locking Welding Clamp	\$31.77

Dealer Schedule.....203

## Vise-Grip Locking C-Clamps

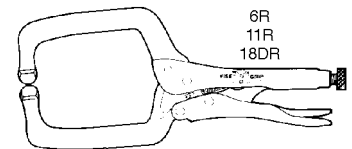
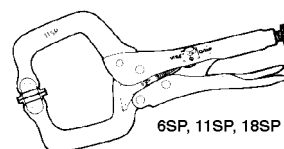

Unique shape of the C-Clamp jams gives far more clamping reach. No. screw adjustment on jaws to hinder clamping action. SP Series have self-leveling swivel pads.

No.	Length	Jaw Adjustment	Throat Height	Throat Depth	Price
6R	6"	2"	2-1/4"	1-3/8"	\$21.07
11R	11"	3-3/4"	3-3/4"	2-1/2"	35.31
18DR	18"	7-1/2"	7-1/2"	9-1/2"	58.27
6SP	6"	2"	2-1/4"	1-3/8"	23.72
11SP	11"	3-3/4"	3-3/4"	2-1/2"	38.22
18SP	18"	8"	4-1/2"	9-1/2"	53.47

Dealer Schedule.....203

## Vise-Grip Chain Wrench

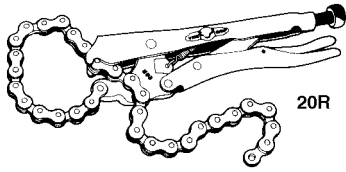

A Chain Clamp and Pipe Wrench with Tremendous Gripping Power and Easy Release.

Adjusts to any size work up to 19" in perimeter. Holds and locks around anything, any size and any shape. Works in close quarters and narrow openings. Holds work that is impossible to hold with any other clamp. When used for pipe work it locks on tight and will not slip. Adjusts to ratchet action. Releases instantly with finger tip pressure on Easy Release.

No.		Price
20R	Vise Grip Chain Wrench	\$40.31
20REP	Repair Chain - 18"	20.35
20EXT	Extension Chain - 18"	20.35

Dealer Schedule.....203

## WISE-GRIP LOCKING WRENCHES

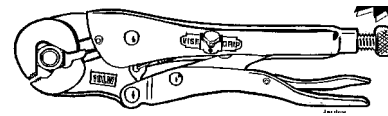

Locks on three sides of a hex fastener. Tremendous force can be applied without marring or slipping off the fastener. Adjusts to over 16 different standard & metric wrench sizes. Includes a wire cutter. Jaw tips are knurled for better gripping. Built to last a lifetime. Display Carded.

No.	Lgth	Wrench Size Range		List
		U.S.	Metric	
VG-04LW	.. 4" .....	1/4" - 9/16"	.... 7mm - 14mm ..	\$16.40

Dealer Schedule.....203

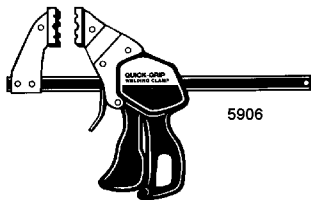

## QUICK-GRIP Welding Clamps

Great for a multitude of clamping uses.

Fast, easy pistol-grip operation frees one hand to hold work. Grooved jaws allow easy clamping of round stock. Features include heat-treated carbon steel jaws and spatter-resistant copper-plated pads.

No.	Description	Price
5906	Quick-Grip Welding Clamp - 6" .....	\$41.64
5912	Quick-Grip Welding Clamp - 18" .....	49.49

Dealer Schedule.....203

## Quick-Adjust Pipe Wrench



Forged Hook Jaw. 2-1/4" jaw capacity equivalent to a standard 14" pipe wrench. Ideal for pipe up to 1-1/2". Broached teeth are ideal for most surfaces. One-handed operation enhances user's speed and convenience. Ratchets quickly to work surface. Smooth release upon job completion. Cast aluminum construction 40% less weight than cast iron. Ergonomic handle ideal for heavy torque and max. comfort, riveted to heat treated handle.

No.	Description	Price
VG-27401	Quick-Adjust Pipe Wrench .....	\$46.66

Dealer Schedule.....203

## Wire Stripping/Crimping Pliers



Cuts and strips wire. Crimps solderless terminals. Insulated non-slip handle.

No.	Description	Price
GN-CRT	Wire Stripper/Crimping Pliers .....	\$7.99

Dealer Schedule.....152

## WISE-GRIP MIG Welding Pliers



**WISE-GRIP MIG Welding Pliers Features:**  
 Specially-designed nose for efficient removal of welding spatter. Induction-hardened cutting edge stays sharp longer. Multiple jaws for drawing out wire and removing or installing contact tips and nozzles. Hammer designed for light welding gun maintenance. Spring-loaded for ease of use. Dipped grips for superior comfort.

Order No.	Description	List
VG-1873303	MIG Welding Pliers .....	\$31.54

Dealer Schedule.....203

*Centralized With Central!*

*Call 1-800-444-8666*

## CTC Combination Pliers

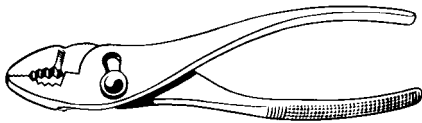

Forged from special analysis steel, carefully machined, hardened and oil tempered. Nickel plated finish, machine polished.

No.		Price
H-26	6" CTC Pliers, 1" Capacity	\$8.75
H-28	8" CTC Pliers, 1-1/4" Capacity	9.43

Dealer Schedule: Broken Carton....162 Carton of 12....203

## 14 Pc. Combination Wrench Sets



### US Wrench Set

Fully Drop Forged. Contains 1 each 1/4", 5/16", 3/8", 7/16", 1/2", 9/16", 5/8", 11/16", 3/4", 13/16", 7/8", 15/16", 1", 1-1/8" Fully Polished. In a convenient storage tray.

### Metric Wrench Set

Fully Drop Forged. Contains 1 each 8, 9, 10, 11, 12, 13, 14, 15, 16, 17, 19, 21, 22, and 24 mm Fully Polished. In a convenient storage tray.

No.	Price
WCS-14... 14 Pc. SAE Combination Wrench Set	\$42.58
WCM-14 .. 14 Pc. Metric Comb. Wrench Set	42.58

Dealer Schedule.....152



## 11 Pc. Combination Wrench Sets

Fully polished chrome plated  
Heat treated and tempered.

### 51004 SAE Wrench Set

Contains: 1/4", 5/16", 3/8", 7/16", 1/2", 9/16", 5/8", 11/16", 3/4", 13/16", 7/8" With convenient storage tray.

### 51005 Metric Wrench Set

Contains: 6, 7, 8, 9, 10, 12, 13, 14, 15, 17, 19mm. With convenient storage tray.

No.	Price
GN-51004 .... 11 Pc. SAE Combination Wrench Set	\$30.98
GN-51005 .... 11 Pc. Metric Comb. Wrench Set	30.98

Dealer Schedule.....152

## Combination/Open End Wrenches

Fully Drop Forged,  
Chrome Plated,  
Fully Polished

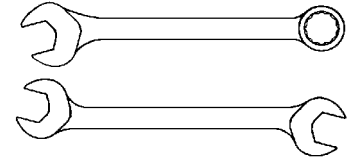

No.	Description	List
WC-04	Combination Wrench, 1/4"	\$3.60
WC-05	Combination Wrench, 5/16"	3.60
WC-06	Combination Wrench, 3/8"	3.60
WC-07	Combination Wrench, 7/16"	3.99
WC-08	Combination Wrench, 1/2"	4.27
WC-09	Combination Wrench, 9/16"	4.54
WC-10	Combination Wrench, 5/8"	4.95
WC-11	Combination Wrench, 11/16"	5.48
WC-12	Combination Wrench, 3/4"	6.55
WC-14	Combination Wrench, 7/8"	7.48
WC-15	Combination Wrench, 15/16"	8.82
WC-16	Combination Wrench, 1"	9.22
WC-17	Combination Wrench, 1-1/16"	9.61
WC-18	Combination Wrench, 1-1/8"	10.15
WC-20	Combination Wrench, 1-1/4"	12.95
WO-0807	1/2" x 7/16" Open End Wrench	3.95

Dealer Schedule.....152



## Needle Nose Pliers

Needle Nose Plier. 6-1/2" Length. Precision drop forged head.  
Double dipped vinyl grip handle. Display Carded.

Order No.	Price
GN-LN65C .... Needle Nose Plies 6-1/2"	\$5.95

Dealer Schedule.....152

## Slip Joint Pliers



Drop forged. Steel plated construction  
Double dipped vinyl grip handles. Precision milled jaws.

No.	Description	Price
GN-SJ6C	Slip Joint Pliers, 6"	\$5.29

Dealer Schedule:

12 or more.....203 Less than 12.....202

All Prices Are Subject To Change Without Notice

### Adjustable Wrenches



Fully Drop Forged,  
Chrome Plated,  
Fully Polished

No.	Description	List
WA-06	Adjustable Wrench, 6" .....	\$8.42
WA-08	Adjustable Wrench, 8" .....	9.35
WA-10	Adjustable Wrench, 10" .....	12.29
WA-12	Adjustable Wrench, 12" .....	14.42
WA-15	Adjustable Wrench, 15" .....	26.65

Dealer Schedule:

6 or more assorted.....152 & 150    Less than 6.....152

### Multi-Groove Pliers



Drop Forged Steel. Chrome Plated. Double-Dipped Vinyl Grip Handle. Polished Head and Milled Jaws. Display Carded.

Order No.	Description	Price
GN-W080C	Multi-Groove Pliers 8" .....	\$7.99
GN-W100C	Multi-Groove Pliers 10" .....	10.84

Dealer Schedule.....152



### Tin Snips, 10"

Vinyl grip handles. Drop forged construction.  
Heat treated polished heads.

No.	Description	Price
GN-T10SC	Tin Snips, 10 inch .....	\$9.29

### Aviation Snips Straight Cut



Chrome vanadium steel for strength and durability.  
1-5/8" serrated blades. Cuts up to 18 gauge metal.

No.	Description	Price
GN-TA10S	Aviation Snips, 10", Straight Cut .....	\$9.29

Dealer Schedule.....152

### C-CLAMPS

Clamp Bodies  
are made of  
High Tensile  
Malleable Iron.  
Extremely Strong!

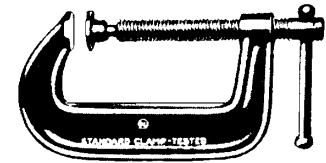

No.	Description	Price
GN-CC3	C-Clamp (3" Jaw Opening) .....	\$6.95
GN-CC4	C-Clamp (4" Jaw Opening) .....	9.35
GN-CC6	C-Clamp (6" Jaw Opening) .....	17.36

Dealer Schedule.....152

### Hi-Visibility Power Tape Measures

Large fractional markings allow for quicker more accurate measurements. Bright Orange Hi-Visibility comfort grip soft case. Positive blade lock, smooth power return.



Packaged On  
Display Card

Order No.	Description	Price
GN-95000	1/2" x 12' Hi-Vis. Power Tape .....	\$4.54
GN-95001	3/4" x 16' Hi-Vis. Power Tape .....	7.21
GN-95002	1" x 25' Hi-Vis. Power Tape .....	13.35

Dealer Schedule:

Display Case of 12.....152 & 150    Broken Case.....152

### Heavy-Duty Bolt Cutters Center Cut - General Purpose



Forged steel construction. Vinyl grips for a firm hold.  
Short cutting edge to accommodate chain link.

Order No.	Description	Price
GN-BC36	H-D Bolt Cutters, 36" .....	\$48.59

Dealer Schedule.....152



### 100' Long Tape Rewind Handle Quick Retrieval

Bright yellow Heavy Duty Tape with clear red and black markings. Folding hook handle. Blades exceed government specifications for accuracy.

Order No.	Description	Price
GN-100E	3/8" x 100' Tape Measure .....	\$25.63

Dealer Schedule.....152

All Prices Are Subject To Change Without Notice



# MAYHEW

## RIVET BUSTER

Rugged chisel hammer forged from high grade steel. Black lacquer finish polished head and bit. Designed for cutting off rivet heads.



No.	Cut Size	Dia. Steel	Length	Price
11300	3/4"	5/8"	6-1/4"	\$10.75

## RIVET SET

Mayhew Rivet Set designed for heading section rivets. Made of high grade steel. Hardened and tempered with a cupped end. Black lacquer finish.



No.	Cup Point	Dia. Steel	Length	Price
20900	3/8"	5/8"	5"	\$10.25

## SOLID PUNCHES

Carefully hammer forged from high grade steel. Hardened and tempered. Heads and points polished. Black lacquer finish.



No.	Pt. Size	Dia. Steel	Length	Price
70001	1/8"	3/8"	5"	\$4.51
70002	3/16"	3/8"	5"	4.55

## PIN PUNCHES

Carefully hammer forged of high grade steel; hardened and tempered. Black lacquer finish.



No.	Pt. Size	Dia. Steel	Length	Price
413-1	3/32"	5/16"	6"	\$4.66
413-2	1/8"	5/16"	6"	4.72
413-3	5/32"	5/16"	6"	4.82
413-4	3/16"	3/8"	6"	5.00
413-5	1/4"	3/8"	6"	5.15
414-1	3/16"	1/2"	6"	7.02
414-3	1/4"	1/2"	6"	6.91
414-4	5/16"	1/2"	6"	7.00

## LINING UP PUNCHES

Hammer forged of high grade steel. Long taper. Black Lacquer finish.



No.	Pt. Size	Dia.	Lgth.	Taper	Price
72010	1/8"	5/16"	8"	3-1/2"	\$6.35
72011	5/32"	3/8"	9"	4-1/4"	6.85
72003	1/4"	5/8"	12"	7-1/2"	11.80
22005	1/4"	3/4"	15"	7-1/4"	18.78
22008	5/16"	5/8"	16"	9-1/2"	18.50
72012	3/16"	1/2"	10"	6-1/2"	8.55

## CENTER PUNCHES

Hammer forged of high grade steel. Black lacquer finish.



No.	Dia. Steel	Length	Price
74001	5/16"	4-1/2"	\$4.10
74002	3/8"	5"	4.50
74003	1/2"	6"	5.55

## PINCH BARS

Forged from high grade steel. Hardened and tempered black lacquer finish. Full polished taper and blade, For prying, alignment work and many other purposes. One end taper and the other end curved leverage blade.



No.	Dia. Steel	Length	Price
75000	1/2"	14"	\$14.40
75001	5/8"	16"	18.80

## Dominator 4 Pc. HOOK & PICK SETS

Harded Chrome Vanadium Shafts



Two composite handle is ergonomically designed for a comfortable secure grip. Capped end allows the user to strike with a hammer without damaging the handle.

Contains: 1 ea. Scratch Awl,  
90° Hook, Curved Hook, Complex Hook.

Set No.	Description	Price
60000	Hook & Pick Set, 10" Long	\$55.65
60003	Mini Hook & Pick Set, 6-1/2" Long	18.80

DEALER SCHEDULE THIS PAGE (Mayhew).....203

**Fax Toll-Free  
1-800-342-7252**

**To Order Call Toll-Free:  
1-800-444-8666**

# MAYHEW

## No. 70 COLD CHISELS

Mayhew Hammer-Forged Chisels. Black lacquer finish. Noted for cutting and durability



No.	Cut Size	Dia. Steel	Length	Price
70-0	1/4"	1/4"	5"	\$4.10
70-1	5/16"	1/4"	5"	4.50
70-2	3/8"	5/16"	5-1/2"	4.65
70-3	7/16"	3/8"	6"	4.80
70-4	1/2"	7/16"	6"	5.40
70-5	5/8"	1/2"	6-1/2"	6.00
70-6	3/4"	5/8"	7"	7.90
70-7	7/8"	3/4"	7-1/2"	9.60
70-8	1"	7/8"	8"	12.90
70-9	1-1/8"	1"	8"	17.75

## No. 150 CAPE CHISEL

Hammer forged and noted for cutting and durability. Black lacquer finish.



No.	Cut Size	Dia. Steel	Length	Price
10401	3/16"	3/8"	12"	\$9.70

## **Dominator** 4 Pc. CARBON SCRAPER SET

Two composite handle is ergonomically designed for a comfortable secure grip. Capped end allows the user to strike with a hammer without damaging the handle. 10" Overall length.



Contains: 1 ea. 1/2", 3/4", 1", 1-1/2".

Set No.	Description	Price
60001	Carbon Scraper Set, 4 pc.	\$59.85

## **Dominator** Specialty Pry Bar Set

Unique Shapes for prying in tight or restricted locations



Contains:

- 1 ea. #40170 - 30"x1/2" Modified Separating Die Bar
- 1 ea. #40172 - 30"x1/2" Modified Rolling Head Pry Bar

Set No.	Description	Price
61361	Specialty Pry Bar Set, 2 pc.	\$106.35

## No. 110 EXTRA LONG COLD CHISELS

Hammer forged from high grade steel. Noted for cutting and durability. Black lacquer finish.



No.	Cut Size	Dia. Steel	Length	Price
70207	1/2"	7/16"	12"	\$8.15
70210	5/8"	1/2"	12"	9.60
70213	3/4"	5/8"	12"	11.80
70217	7/8"	3/4"	12"	15.30
70221	1"	3/4"	12"	16.60

## No. 250 ROUND NOSE CHISEL

Hammer forged and noted for cutting and durability. Black lacquer finish.



No.	Cut Size	Dia. Steel	Length	Price
10501	3/16"	3/8"	6"	\$10.07

## PUNCH & CHISEL 14 PC. KIT



14 Pc. Kit Contains:

- 1 ea. .... 70-0, 70-2, 70-4, 70-5, 70-6 ..... Cold Chisels
- 1 ea. .... 413-1, 413-2, 413-3, 413-4, 413-5 ..... Pin Punches
- 1 ea. .... 70001, 70002 ..... Solid Punches
- 1 ea. .... 74002 ..... Center Punch
- 1 ea. .... 72010 ..... Lining Up Punch

Set No.	Description	Price
61044	Punch & Chisel Kit, 14 pc.	\$99.60



## **The Dominator**

Screwdriver Pry Bar by Mayhew

Featuring the all-new capped end which allows the user to strike the pry bar with a hammer without damaging the head. Hardened and tempered their entire length for maximum durability. Curved blade.

Order No.	Description	O.A.L.	Stock Dia.	List
60140	7" Pry Bar	12"	3/8"	\$21.05
60144	12" Pry Bar	17"	3/8"	22.18
60146	18" Pry Bar	25"	1/2"	34.50
60148	24" Pry Bar	31"	1/2"	40.75
40138	36" Pry Bar	36"	5/8"	79.95
40139	42" Pry Bar	42"	5/8"	87.80
40164	44" Pry Bar	44"	7/8"	130.05
40160	48" Pry Bar	48"	3/4"	119.65
40162	58" Pry Bar	58"	3/4"	132.00

# LUMILITE Krypton Flashlights

## Grip Series Super Heavy Duty 100% rubber

### Heavy Duty Grip series.

Shock, corrosion and weather resistant. Super Bright Krypton Bulb. Wrist lanyard for secure one-handed use.

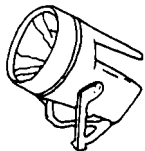
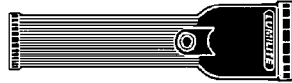

### 6-volt Z-Lite Lantern.

Super Bright Krypton bulb, weather resistant/rubberized body, 6 position adjustable stand. Battery sold separately.

No.	Description	List
FL-2450	Grip Rubber 2AA Flashlight	\$5.29
FL-2550	Grip Rubber 2D Flashlight	7.19
FL-4800	6-Volt Z-Lite Lantern	15.98
FL-9999	Belt Holster for 2AA Flashlight	4.99

Dealer Schedule.....203



## 6 PC. Screwdriver Set

High carbon steel blades, nickle plated top quality extruded shock resistant handles. Precision ground tips. Contains: Slotted 3"x1/8", 4"x3/16", 4"x1/4", 6"x5/16", Phillips #1x3", #2x4"

Order No.	Price
GN-G6C	6 PC. Screwdriver Set \$18.18

Dealer Schedule.....152

## E-Z Break Out Punch

Point, Push & Pop Action



Tamper Proof "Window Breaking" power setting. High Visibility Cushion Grip. Spring-Loaded Energy Focusing Super Sharp Tip. Permanently Sealed Cone and Cap. Fully Hardened Steel Tip. Protective Tip Cap reduces the chance of injury.

No.	Description	Price
GH-7901	E-Z Breakout Punch	\$16.58

Dealer Schedule.....102

PRICES ARE SUBJECT TO CHANGE WITHOUT NOTICE

## Hi-Torque Ratcheting Screwdriver



Contains 12 interchangeable Bits: 1/8", 3/16", 1/4", and 9/32" Slotted; #0, #1, #2 and #3 Phillips; 5/32" & 3/16" Hex; T10 & T20 Star. Stainless Steel Shaft. Includes magnetic extension bit for longer reach. Convenient bit magazine stores in handle. Oval ergonomic handle with rubberized grip.

Order No.	Price
GN-8026E	Hi-Torque Ratchet Screwdriver \$8.29

Dealer Schedule.....152



## Pocket Magnetic Pickup Tool

Retracts to 5" - Extends to 24"

No.	Description	List
W1908	Magnetic Pickup Tool, 3 lb.	\$3.45

Dealer Schedule: 1-14.....152 Carton of 15.....154

## Alkaline & Industrial Batteries



Alkaline Batteries provide long life and superior performance when used in all your battery operated devices. Retains 85% of original life after 5 years in storage. **NEW PRICES AS OF 7/25/2019** Priced Per Each.

No.	Description	Pkg. Qty.	Each
BAT-DRA	D Size Alk. Battery	12	\$4.08
BAT-CRA	C Size Alk. Battery	12	3.43
BAT-AAR	AA Size Alk. Battery	24	1.91
BAT-AAARA	AAA Size Alk. Battery	24	1.91
BAT-9VRA	9-volt Alk. Battery	12	6.18
BAT-6LRI	6-volt Lantern Ind. Battery	3	8.57

Dealer Schedule: **Full Packages** ..... 205  
Broken Packages ..... 203

**Fax Toll-Free  
1-800-342-7252**

## MAKITA Abrasive Cutting Wheel

No. 724603-3 (14 Inch)

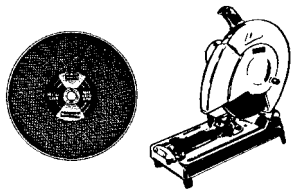

724603-3 wheel shown with model 2414 saw.

Model	Blade		Cutting Capacity		Amps (115V)	No Load Speed
	Dia.	Arbor	90°	45°		
2414	14"	5/8" & 1"	4"	4"	13.0	3800 rpm

For all ferrous materials (Steel, Cast Iron) and other hard metals. Reinforced. 1" arbor. Maximum safe speed 4400RPM.

Order No. Price  
724603-3 ..... 14" Abrasive Cut-Off Wheel ..... \$16.42

Dealer Schedule.....102

## SAIT Depressed Center Wheels

(For Grinders & Sanders)

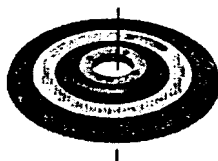

Keep Wheel Cover In Place. Wear Safety Goggles.

For metal polishing and general and flat grinding. Aluminum oxide abrasive grains are evenly distributed to give a smooth surface.

No.	Dimensions	Grit	RPM	Price
ST-20013	4" x 1/4" x 5/8"	24	13,000	\$4.35
ST-20063	4-1/4" x 1/4" x 7/8"	24	10,900	4.35

Dealer Schedule.....102

## SAIT Grinding & Cutting Wheels



**Grade A24R:** Alluminum Oxide General Purpose, Long Life, For Heavy Working Conditions, Iron, Steel, Normal Ferrous Metals, Welds.

### Depressed Center Wheel

Order No.	Size	Width	Bore	Max. RPM	Price
ST-20070	5"	1/4"	7/8"-9"	12,200	\$5.40
ST-20086	7"	1/4"	5/8"-11"	8,500	10.30
ST-20096	9"	1/4"	5/8"-11"	6,600	13.45

### Abrasive Cutting Wheel

ST-23412	12"	1/8"	1"-8"	6,300	9.40
----------	-----	------	-------	-------	------

Dealer Schedule.....102

PRICES ARE SUBJECT TO CHANGE WITHOUT NOTICE.

## MAKITA Wire Cup Brush



FOR MAKITA  
GRINDERS  
&  
SANDERS

Keep Wheel Cover in Place. Wear Safety Goggles.

Direct spindle mount, .014" crimped carbon steel wire. Excellent for flat surfaces, edges, paint, scale, light rust removal. Provides continuous brushing action and relatively fine finish. 3" diameter (M10 x 1.25) Maximum Safe Speed is 12,500 RPM. For Makita 9501B sander and grinder.

Order No. Price  
743201-4 ..... Crimped Wire Cup Brush ..... \$25.35

Dealer Schedule.....102

## MAKITA Abrasive Discs



(SOLD 5 PER CARTON. NO BROKEN CARTONS)

Order No.	Size	Grit	For No.	Per 5
742036-A5	4"	24	9501B	\$8.95
742038-A5	4"	50	9501B	7.27
742039-A5	4"	80	9501B	7.27
742040-A5	4"	120	9501B	7.27

Dealer Schedule.....102

## Wire Scratch Brush



BW-SH Shoe Handle Scratch Brush. Tempered steel wire - 4 rows wide, 16 rows long - Curved hardwood handle.

No. Price  
BW-SH ..... Shoe Handle Scratch Brush ..... \$3.65

Dealer Schedule.....152

# Call Toll-Free 1-800-444-8666

## Trades Marker



A unique all-purpose marker that comes in a push-button holder that advances the stick as needed. This eliminates all the hassles found with the old paper wrapped china markers. The easy-to-load refills never need sharpening and the holder lets you use the stick right down to the end. Marks on plastic, glass, wood, cardboard, metal, and paper. Marks won't rub off and are weather resistant. Holder has a handy pocket clip.

No.	Description	List
LC-96000	Holder w/5 Colors	\$10.50
LC-96009	Orange Refill, 6 pack	5.95
LC-96042	White Refill, 6 pack	5.95
LC-96043	Yellow Refill, 6 pack	5.95
LC-96044	Black Refill, 6 pack	5.95
LC-96045	Red Refill, 6 pack	5.95

Dealer Schedule.....152

## Valve Action Paint Marker



Valve action fiber tip is replaceable to assure full use of paint supply. Make long-lasting crisp lines or bold marks. Paint formulated for industrial and farm applications. Dries in minutes. Weather-resistant marks. Ideal for many surfaces; metal, glass, wood, rubber, plastic, cardboard and paper.

No.	Description	List
LC-96820	White Marker	\$5.35
LC-96821	Yellow Marker	5.35
LC-96822	Red Marker	5.35
LC-96823	Black Marker	5.35
LC-9867	Replacement Tip Only	1.22

Dealer Schedule.....152

## Parts Cleaning Brush



A handy brush for cleaning parts that have been disassembled from engines, machinery, etc. Long comfortable grip, solid wood handle. Metal ferrule. Carded.

Order No.	Price	
GN-PCB	Parts Cleaning Brush	\$3.98

Dealer Schedule.....152

PRICES ARE SUBJECT TO CHANGE WITHOUT NOTICE

## Quik-Stik Twist Up Paint Marker



Twist-up advance of the stick. Plastic holder with self storing cap prevents breakage, keeps hands and clothing clean. More marks for the money, lasts 20% longer than other brands. Bright, bold fade resistant colors. Smooth marking, fast drying paint marks on virtually any surface. Metal, glass, plastic, wood, cardboard, paper, etc. Marks dry in 5-7 minutes. Marking temperature range: 0°F to 140°F. (-17°C to 60°C)

No.	Description	List
LC-61049	Quik Stik Marker (Red)	\$7.25
LC-61050	Quik Stik Marker (Black)	7.25
LC-61051	Quik Stik Marker (White)	7.25
LC-61053	Quik Stik Marker (Yellow)	7.25
LC-61069	Quik Stik Marker (Green)	7.25

Dealer Schedule.....152

## SAIT Screen Roll



Silicon carbide grain  
Long life - Waterproof  
Non-loading screen cloth

1-1/2" x 5 Yards

Order No.	Description	Price
ST-84089	80 Grit Screen Roll	\$28.65
ST-84092	120 Grit Screen Roll	14.65

## SAIT Handy Roll

Aluminum Oxide  
Full Resin - Cloth Laced

x 50 Yards



Order No.	Description	Price
ST-80805	80 Grit Shop Roll	\$38.95
ST-81005	100 Grit Shop Roll	37.00
ST-81205	120 Grit Shop Roll	37.70

Dealer Schedule.....102

**Threaded Rod**

(Zinc Plated - N.C. Coarse Threads - Grade 2)



No.	Size x Lgth.	Bundle	Each
RB-04-36	1/4"x 36"	5	\$2.49
RB-05-36	5/16"x 36"	5	3.30
RB-06-36	3/8"x 36"	5	4.05
RB-07-36	7/16"x 36"	5	5.33
RB-08-36	1/2"x 36"	5	6.86
RB-10-36	5/8"x 36"	3	10.58
RB-12-36	3/4"x 36"	3	14.10
RB-14-36	7/8"x 36"	3	21.05
RB-16-36	1"x 36"	3	27.86
RB-18-36	1-1/8"x 36"	2	43.95
RB-20-36	1-1/4"x 36"	1	50.87
RB-24-36	1-1/2"x 36"	1	93.30
RB-04-72	1/4"x 72"	5	\$5.98
RB-05-72	5/16"x 72"	5	6.60
RB-06-72	3/8"x 72"	5	8.10
RB-07-72	7/16"x 72"	5	10.66
RB-08-72	1/2"x 72"	5	13.72
RB-10-72	5/8"x 72"	3	21.16
RB-12-72	3/4"x 72"	3	28.20
RB-14-72	7/8"x 72"	3	42.10
RB-16-72	1"x 72"	3	55.71

Dealer Schedule:

Full Bundle.....33/133 Broken Bundle.....152

**REDI-BOLT STEEL  
COUPLING NUTS**  
(Zinc Plated)



No.	Tap Size	Length	Pkg.	Each
RB-C04	1/4-20	1-3/4"	50	\$.66
RB-C05	5/16-18	1-3/4"	25	1.02
RB-C06	3/8-16	1-3/4"	25	1.22
RB-C07	7/16-14	1-3/4"	25	1.35
RB-C08	1/2-13	1-3/4"	25	1.35
RB-C10	5/8-11	2-1/8"	20	2.40
RB-C12	3/4-10	2-1/4"	20	2.99
RB-C14	7/8-9	2-1/2"	10	5.30
RB-C16	1-8	2-1/2"	10	6.95
RB-C18	1-1/8-7	3"	5	10.99
RB-C20	1-1/4-7	3-1/4"	5	13.82
RB-C24	1-1/2-6	3-1/2"	5	17.98

Dealer Schedule: Full Package ..... 33/133  
Broken Package ..... 152

**Stainless Steel 18-8  
Threaded Rod**



Order No.	Size x Lgth.	Each
TRSS-0420-36	1/4"-20x 36"	\$5.90
TRSS-0518-36	5/16"-18x 36"	8.35
TRSS-0616-36	3/8"-16x 36"	9.79
TRSS-0812-36	1/2"-13x 36"	15.50
TRSS-1011-36	5/8"-11x 36"	22.69
TRSS-1210-36	3/4"-10x 36"	33.56

Dealer Schedule.....125

(Call for availability of other sizes of Stainless Steel Rod)

**Threaded Rod**

**GRADE B-7 ALLOY**



N.C. Coarse Threads - Plain Oil Finish

Order No.	Size x Lgth.	Bundle	Each
TR7-04-36	1/4"x 36"	5	\$4.20
TR7-05-36	5/16"x 36"	5	6.02
TR7-06-36	3/8"x 36"	5	6.68
TR7-07-36	7/16"x 36"	5	11.04
TR7-08-36	1/2"x 36"	5	11.85
TR7-10-36	5/8"x 36"	3	16.48
TR7-12-36	3/4"x 36"	3	25.00
TR7-14-36	7/8"x 36"	3	32.41
TR7-16-36	1"x 36"	3	45.01
TR7-20-36	1-1/4" x 36"	1	72.05
TR7-24-36	1-1/2" x 36"	1	93.74
TR7-04-72	1/4"x 72"	5	8.40
TR7-05-72	5/16"x 72"	5	12.67
TR7-06-72	3/8"x 72"	5	15.91
TR7-07-72	7/16"x 72"	5	22.08
TR7-08-72	1/2"x 72"	5	27.50
TR7-10-72	5/8"x 72"	3	38.57
TR7-12-72	3/4"x 72"	3	56.61
TR7-14-72	7/8"x 72"	3	67.96
TR7-16-72	1"x 72"	3	90.02

Schedule: Full Bundle.....203 Broken Bundle.....152

**Acme Threads**

3' Lengths

Plain Finish- Grade 2



Order No.	Size	Pitch	Wire Size	Per Ft.
400-0416	1/4"	16	.214	\$2.68
400-0612	3/8"	12	.325	3.79
400-0810	1/2"	10	.440	6.03
400-1006	5/8"	8	.550	9.39
400-1008	5/8"	6	.550	8.62
400-1206	3/4"	6	.656	10.96
400-1210	3/4"	10	.687	11.96
400-1406	7/8"	6	.780	15.34
400-1604	1"	4	.875	19.24
400-1605	1"	5	.887	19.90
400-1805	1-1/8"	5	1.012	26.81
400-2005	1-1/4"	5	1.136	33.56
400-2404	1-1/2"	4	1.369	47.27
400-2804	1-3/4"	4	1.615	63.89
400-3204	2"	4	1.862	87.80

Dealer Schedule .....102

**Acme Nuts**  
Plain Finish

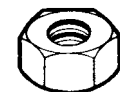

No.	Size-Pitch	Each	No.	Size-Pitch	Each
413-0416	1/4"-16	\$4.15	413-1604	1"-4	\$14.17
413-0612	3/8"-12	5.01	413-1605	1"-5	14.70
413-0810	1/2"-10	5.65	413-1805	1-1/8"-5	17.80
413-1006	5/8"-6	6.40	413-2005	1-1/4"-5	20.33
413-1008	5/8"-8	6.40	413-2404	1-1/2"-4	32.51
413-1206	3/4"-6	8.69	413-2804	1-3/4"-4	63.58
413-1210	3/4"-10	8.69	413-3204	2"-4	85.99
413-1406	7/8"-6	11.28			

Dealer Schedule.....102



## LAG SCREWS

Hex Head - Zinc Plated - Gr. 2



Order No.	Dia. x Lgth.	Pkg.	Per C
LS-04-0100	.. 1/4 x 1	100	\$12.60
LS-04-0108	.. 1/4 x 1-1/2	100	12.78
LS-04-0200	.. 1/4 x 2	100	14.40
LS-04-0208	.. 1/4 x 2-1/2	100	17.51
LS-04-0300	.. 1/4 x 3	100	19.05
-----			
LS-05-0100	.. 5/16 x 1	100	15.96
LS-05-0108	.. 5/16 x 1-1/2	100	21.66
LS-05-0200	.. 5/16 x 2	100	24.60
LS-05-0208	.. 5/16 x 2-1/2	100	34.92
LS-05-0300	.. 5/16 x 3	100	37.11
LS-05-0400	.. 5/16 x 4	50	38.56

Order No.	Dia. x Lgth.	Pkg.	Per C
LS-06-0100	.. 3/8 x 1	100	\$21.39
LS-06-0108	.. 3/8 x 1-1/2	100	26.34
LS-06-0200	.. 3/8 x 2	100	30.21
LS-06-0208	.. 3/8 x 2-1/2	50	45.30
LS-06-0300	.. 3/8 x 3	50	50.71
LS-06-0400	.. 3/8 x 4	50	51.47
LS-06-0500	.. 3/8 x 5	50	84.45
LS-06-0600	.. 3/8 x 6	50	108.52
-----			
LS-08-0200	.. 1/2 x 2	50	57.19
LS-08-0208	.. 1/2 x 2-1/2	50	65.08
LS-08-0300	.. 1/2 x 3	50	107.19

Order No.	Dia. x Lgth.	Pkg.	Per C
LS-08-0400	.. 1/2 x 4	25	\$117.06
LS-08-0500	.. 1/2 x 5	25	150.25
LS-08-0600	.. 1/2 x 6	25	183.45
-----			
LS-10-0400	.. 5/8 x 4	25	179.25
LS-10-0600	.. 5/8 x 6	25	233.19

**LAG SCREWS  
DEALER SCHEDULE:**

Full Box	304
Broken Box	102

## SHEET METAL SCREWS

100 Screws  
Per Package

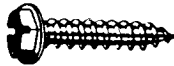

No Broken  
Packages

### HEX WASHER HEAD---ZINC PLATED

No.	Gauge	Length	Fract. Equiv.	Per C
SMSH-08-08	8	1/2	5/32 Full	\$3.71
SMSH-08-16	8	1	5/32 Full	4.86
SMSH-10-08	10	1/2	3/16	4.60
SMSH-10-12	10	3/4	3/16	5.26
SMSH-10-16	10	1	3/16	6.03
SMSH-10-24	10	1-1/2	3/16	8.34
SMSH-12-12	12	3/4	7/32	9.70
SMSH-12-16	12	1	7/32	11.80
SMSH-12-24	12	1-1/2	7/32	15.90
SMSH-14-12	14	3/4	1/4	12.70
SMSH-14-16	14	1	1/4	13.80
SMSH-14-24	14	1-1/2	1/4	15.97

Dealer Schedule.....203

## TEK SCREWS

(Self Drilling Screws)

TEK Screws are self drilling fasteners that in one motion, drill their own hole, tap and fasten in metal and other materials.



Hex Washer Head, Zinc Plated  
Sold In Packages Of 100 Only.

Order No.	Dia. x Lgth.	Per C
TSH-10-0008	#10 (3/16) x 1/2"	\$8.86
TSH-10-0012	#10 (3/16) x 3/4"	10.00
TSH-10-0100	#10 (3/16) x 1"	11.32
TSH-10-0104	#10 (3/16) x 1-1/4"	12.94
TSH-10-0108	#10 (3/16) x 1-1/2"	13.98
TSH-12-0012	#12 (7/32) x 3/4"	13.80
TSH-12-0100	#12 (7/32) x 1"	15.72
TSH-12-0108	#12 (7/32) x 1-1/2"	20.46
TSH-12-0200	#12 (7/32) x 2"	24.60
TSH-14-0012	1/4" x 3/4"	17.00
TSH-14-0100	1/4" x 1"	19.00
TSH-14-0108	1/4" x 1-1/2"	25.17
TSH-14-0200	1/4" x 2"	29.55

Dealer Schedule.....304

## SHEET METAL SCREWS

100 Screws  
Per Package



No Broken  
Packages

### PAN HEAD---ZINC PLATED

No.	Gauge	Length	Fract. Equiv.	Per C
SMSP-08-08	8	1/2	5/32 Full	\$3.49
SMSP-08-16	8	1	5/32 Full	4.74
SMSP-10-08	10	1/2	3/16	4.14
SMSP-10-12	10	3/4	3/16	4.74
SMSP-10-16	10	1	3/16	5.43
SMSP-10-24	10	1-1/2	3/16	8.29
SMSP-12-12	12	3/4	7/32	6.92
SMSP-12-16	12	1	7/32	8.30
SMSP-12-24	12	1-1/2	7/32	8.86
SMSP-14-12	14	3/4	1/4	9.32
SMSP-14-16	14	1	1/4	10.95
SMSP-14-24	14	1-1/2	1/4	12.80

Dealer Schedule.....203

### Sheet Metal Screw Assortment

Both Hex Washer Head and Pan Head screws. 25 of each size - 600 pieces total. Packaged in a transparent plastic box with heavy duty hinges and snap-tight lid. Box size: 14-1/4" x 9-1/8" x 2".

No.	Desc.	Net
SMS-A	Screw Assortment	\$26.90

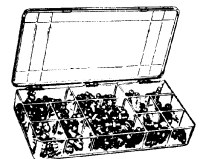

*Centralize with Central*  
**Call Toll-Free**  
**1-800-444-8666**

**TRUSS HEAD  
MACHINE SCREWS**



Zinc Plated - Nuts Not Included - No Broken Packages

Order No.	Dia.	Lgth.	Pkg.	Per C
MST-03-0008	#10-24	1/2"	100	\$6.87
MST-03-0012	#10-24	3/4"	100	7.73
MST-03-0100	#10-24	1"	100	9.40
MST-03-0104	#10-24	1-1/4"	100	10.24
MST-03-0108	#10-24	1-1/2"	100	11.34
MST-03-0200	#10-24	2"	100	13.90
MST-04-0008	1/4"-20	1/2"	100	7.52
MST-04-0012	1/4"-20	3/4"	100	8.10
MST-04-0100	1/4"-20	1"	100	9.09
MST-04-0104	1/4"-20	1-1/4"	100	11.40
MST-04-0108	1/4"-20	1-1/2"	100	13.45
MST-04-0200	1/4"-20	2"	100	15.64
MST-04-0208	1/4"-20	2-1/2"	100	17.18
MST-05-0008	5/16"-18	1/2"	100	16.60
MST-05-0012	5/16"-18	3/4"	100	18.80
MST-05-0100	5/16"-18	1"	100	18.95
MST-05-0104	5/16"-18	1-1/4"	100	20.07
MST-05-0108	5/16"-18	1-1/2"	100	25.33
MST-05-0200	5/16"-18	2"	100	27.16

**ROUND HEAD  
MACHINE SCREWS**



Zinc Plated - Nuts Not Included - No Broken Packages

Order No.	Dia.	Lgth.	Pkg.	Per C
MSR-0632-0008	#6-32	1/2"	100	\$3.93
MSR-0632-0100	#6-32	1"	100	4.43
MSR-0832-0008	#8-32	1/2"	100	4.53
MSR-0832-0100	#8-32	1"	100	5.87
MSR-1024-0008	#10-24	1/2"	100	5.03
MSR-1024-0100	#10-24	1"	100	6.73
MSR-1032-0008	#10-32	1/2"	100	5.30
MSR-1032-0100	#10-32	1"	100	7.13

**MACHINE SCREW NUTS  
(Zinc Plated - Full Packages Only)**



No.	Size	Pkg.	Per C
MSN-00632	#6-32	100	\$2.62
MSN-00832	#8-32	100	2.81
MSN-01032	#10-32	100	3.03
MSN-01024	#10-24	100	3.03
MSN-04020	1/4"-20	100	4.80
MSN-05018	5/16"-18	100	8.09

Machine Screw & Nuts Dealer Schedule.....304

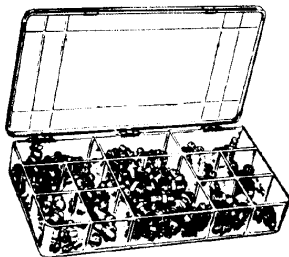

**Round Head  
Machine Screw  
Assortment**

Screws & Nuts Packaged in a transparent plastic box with heavy duty hinges and snap-tight lid. **(400 Pieces)**  
Box size 8-1/2" x 4-3/4" x 1-1/2".

#MSR-A Assortment Consists of:

Screw Size	Qty.	Screw Size	Qty.	Nut Size	Qty.
#6-32x1/2"	25	#10-32x1/2"	25	#6-32	50
#6-32x1"	25	#10-32x1"	25	#8-32	50
#8-32x1/2"	25	#10-24x1/2"	25	#10-32	50
#8-32x1"	25	#10-24x1"	25	#10-24	50

No.	Net
MSR-A..... Rd. Head Mach. Screw Assortment ...	\$21.49

**#3 HEAD PLOW SCREWS**

Grade 5 - Coarse Thread - NUTS NOT INCLUDED

**PLAIN FINISH**



Order No.	Dia. x Lgth.	Pkg.	Per C
PS53-06-0100	3/8 x 1	100	\$33.13
PS53-06-0104	3/8 x 1-1/4	100	34.97
PS53-06-0108	3/8 x 1-1/2	100	37.54
PS53-06-0112	3/8 x 1-3/4	100	43.33
PS53-06-0200	3/8 x 2	100	47.49
PS53-07-0208	3/8 x 2-1/2	50	59.59
PS53-07-0104	7/16 x 1-1/4	50	53.90
PS53-07-0108	7/16 x 1-1/2	50	56.00
PS53-07-0112	7/16 x 1-3/4	50	62.21
PS53-07-0200	7/16 x 2	50	65.49
PS53-07-0204	7/16 x 2-1/4	50	74.21
PS53-07-0208	7/16 x 2-1/2	50	79.90
PS53-07-0300	7/16 x 3	50	95.03
PS53-08-0108	1/2 x 1-1/2	50	73.08
PS53-08-0112	1/2 x 1-3/4	50	77.59
PS53-08-0200	1/2 x 2	50	82.21
PS53-08-0204	1/2 x 2-1/4	50	89.59
PS53-08-0208	1/2 x 2-1/2	50	97.28
PS53-08-0300	1/2 x 3	50	114.67
PS53-10-0200	5/8 x 2	25	175.28
PS53-10-0208	5/8 x 2-1/2	25	210.26
PS53-10-0300	5/8 x 3	25	250.15
PS53-10-0308	5/8 x 3-1/2	25	268.20

**DOME HEAD PLOW SCREWS**

GRADE 8 - Coarse Thread - NUTS NOT INCLUDED

**PLAIN FINISH**

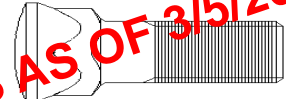

Order No.	Dia. x Lgth.	Pkg.	Per C
PS8D-10-0200	5/8 x 2	25	\$194.83
PS8D-10-0208	5/8 x 2-1/2	25	216.25
PS8D-10-0212	5/8 x 2-3/4	25	231.45
PS8D-10-0300	5/8 x 3	25	256.79
PS8D-12-0200	3/4" x 2"	20	283.34
PS8D-12-0208	3/4 x 2-1/2	20	316.69
PS8D-12-0300	3/4 x 3	20	359.93
PS8D-12-0308	3/4 x 3-1/2	20	392.09

**CLIPPED HEAD PLOW SCREWS**

Grade 5 - Coarse Thread - NUTS NOT INCLUDED

**PLAIN FINISH**



Order No.	Dia. x Lgth.	Pkg.	Per C
PSCH-06-0108	3/8" x 1-1/2"	100	\$51.75
PSCH-07-0108	7/16" x 1-1/2"	50	72.78

**ELLIPTIC HEAD  
PLOW SCREWS**

Grade 8 - Plain Finish - Coarse Thread  
For Danish Tine Sweeps



Order No.	Dia. x Lgth.	Pkg.	Per C
PSEL-06-0108	3/8 x 1-1/2	100	\$41.04

Plow Screws Dealer Schedule: Full Package ..... 304  
Broken Package ..... 102



### METRIC HEX NUTS

(M.C.) Metric Coarse - Zinc Plated



Order No.	Size MM	Pkg.	Per C
HNMC-06	6-1.00	50	\$7.24
HNMC-08	8-1.25	50	12.42
HNMC-10	10-1.50	50	19.74
HNMC-12	12-1.75	50	29.30
HNMC-16	16-2.00	25	56.94
HNMC-20	20-2.50	10	132.24
Dealer Schedule: Full Package			304
Broken Package			102

**NEW PRICES AS OF 3/5/2018**

### METRIC CAP SCREWS

Hex Head - Heat Treated - Zinc Plated  
8.8 Metric Coarse (M.C.) Threads

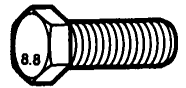

Order No.	Size MM	Pkg.	Per C
CSMC-06-016	6-1.00 x 16	50	\$16.52
CSMC-06-020	6-1.00 x 20	50	17.95
CSMC-06-025	6-1.00 x 25	50	19.20
CSMC-06-030	6-1.00 x 30	50	19.20
CSMC-06-040	6-1.00 x 40	50	24.84
CSMC-06-050	6-1.00 x 50	50	29.26
CSMC-06-060	6-1.00 x 60	50	34.46

**NEW PRICES AS OF 6/27/2019**

### METRIC LOCK WASHERS

Std. Spring Lock Type - Zinc Plated  
Sold In Full Packages Only!



No.	Size	Pkg.	Per C
LW-M06	6mm	100	\$6.16
LW-M08	8mm	100	7.01
LW-M10	10mm	100	13.34
LW-M12	12mm	50	18.28
LW-M16	16mm	25	30.87
LW-M20	20mm	10	43.34

**NEW PRICES AS OF 3/5/2018**

### METRIC FLAT WASHERS

Zinc Plated  
Sold In Full Packages



No.	Bolt Size	I.D.	O.D.	Pkg. Qty.	Per C
FWM-06	6mm	6.4	2.5	100	\$5.82
FWM-08	8mm	8.4	17.0	100	7.44
FWM-10	10mm	10.5	21.0	100	11.55
FWM-12	12mm	13.0	24.0	50	15.14
FWM-16	16mm	17.0	30.0	25	33.07
FWM-20	20mm	21.0	37.0	10	47.39

Metric Washers Dealer Schedule.....304

**NEW PRICES AS OF 6/27/2019**

### METRIC ASSORTMENT CAP SCREWS & HEX NUTS

Hex Head - Heat Treated - Zinc Plated  
8.8 Metric Coarse (M.C.) Threads



220 cap screws and 40 hex nuts in 32 sizes in a 3"x18"x12" heavy-duty metric case with latched lid and scooped compartments.

No.	Net
CSMC-A1	Metric Bolt & Nut Assortment ..... \$123.75

**NEW PRICES AS OF 6/27/2019**

### SERRATED TRUSS HEAD MACHINE SCREWS

Zinc Plated - Nuts Not Included

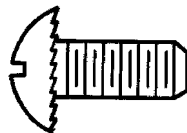

Order No.	Dia.	Lgth.	Pkg.	Per C
MSS-04-0008	1/4"-20	1/2"	50	\$27.00
MSS-04-0012	1/4"-20	3/4"	50	30.27
MSS-04-0100	1/4"-20	1"	50	63.49
MSS-05-0008	5/16"-18	1/2"	50	49.91
MSS-05-0012	5/16"-18	3/4"	50	55.53
MSS-05-0100	5/16"-18	1"	50	59.67
MSS-05-0104	5/16"-18	1-1/4"	50	63.23
MSS-05-0108	5/16"-18	1-1/2"	50	72.00
MSS-06-0008	3/8"-16	1/2"	25	81.00
MSS-06-0012	3/8"-16	3/4"	25	89.96
MSS-06-0100	3/8"-16	1"	25	180.88
MSS-06-0104	3/8"-16	1-1/4"	25	185.00

Dealer Schedule: Full Package....304 Broken Package....102

**NEW PRICES AS OF 6/27/2019**

CSMC-12-020	12-1.75 x 20	25	86.88
CSMC-12-025	12-1.75 x 25	25	86.88
CSMC-12-030	12-1.75 x 30	25	90.42
CSMC-12-035	12-1.75 x 35	25	90.42
CSMC-12-040	12-1.75 x 40	25	97.92
CSMC-12-050	12-1.75 x 50	25	102.75
CSMC-12-060	12-1.75 x 60	15	107.61
CSMC-12-070	12-1.75 x 70	15	123.48
CSMC-12-080	12-1.75 x 80	10	162.55
CSMC-12-090	12-1.75 x 90	10	177.98
CSMC-12-100	12-1.75 x 100	10	195.65
CSMC-14-080	14-2.00 x 80	10	2.1298
CSMC-14-100	14-2.00 x 100	10	3.0497
CSMC-16-030	16-2.00 x 30	10	153.13
CSMC-16-040	16-2.00 x 40	10	170.19
CSMC-16-050	16-2.00 x 50	10	191.31
CSMC-16-060	16-2.00 x 60	10	207.03
CSMC-16-070	16-2.00 x 70	10	236.31
CSMC-16-080	16-2.00 x 80	10	261.31
CSMC-16-090	16-2.00 x 90	10	351.63
CSMC-16-100	16-2.00 x 100	10	376.63
CSMC-20-040	20-2.50 x 40	10	295.95
CSMC-20-050	20-2.50 x 50	10	321.87
CSMC-20-060	20-2.50 x 60	10	368.47
CSMC-20-070	20-2.50 x 70	10	498.62
CSMC-20-080	20-2.50 x 80	10	561.28
CSMC-20-090	20-2.50 x 90	10	611.94
CSMC-20-100	20-2.50 x 100	10	617.27

Dealer Schedule: Full Package ..... 304  
Broken Package ..... 102

CALL FOR OTHER SIZES AVAILABLE ON REQUEST.



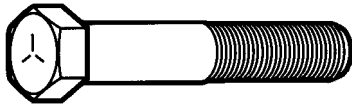

# HEX HEAD CAP SCREWS

## Grade 5 - Heat Treated - Zinc Plated - FINE (N.F.) THREADS

Order No.	Dia. x Lgth.	Pkg.	Per C	Order No.	Dia. x Lgth.	Pkg.	Per C
CS5F-04-0012	1/4 x 3/4	100	\$11.28	CS5F-06-0300	3/8 x 3	50	\$59.00
CS5F-04-0100	1/4 x 1	100	12.42	CS5F-07-0108	7/16 x 1-1/2	50	51.42
CS5F-04-0108	1/4 x 1-1/2	100	16.50	CS5F-07-0200	7/16 x 2	50	65.99
CS5F-04-0112	1/4 x 1-3/4	100	18.61	CS5F-07-0208	7/16 x 2-1/2	50	80.55
CS5F-04-0200	1/4 x 2	100	19.89	CS5F-08-0100	1/2 x 1	50	49.00
CS5F-04-0208	1/4 x 2-1/2	100	23.31	CS5F-08-0108	1/2 x 1-1/2	50	61.89
CS5F-04-0300	1/4 x 3	100	31.28	CS5F-08-0200	1/2 x 2	50	76.73
CS5F-05-0012	5/16 x 3/4	100	15.78	CS5F-08-0208	1/2 x 2-1/2	50	91.06
CS5F-05-0100	5/16 x 1	100	17.75	CS5F-08-0300	1/2 x 3	25	128.49
CS5F-05-0108	5/16 x 1-1/2	100	23.39	CS5F-10-0108	5/8 x 1-1/2	25	107.12
CS5F-05-0200	5/16 x 2	100	30.78	CS5F-10-0200	5/8 x 2	25	128.01
CS5F-05-0208	5/16 x 2-1/2	100	35.06	CS5F-10-0208	5/8 x 2-1/2	25	153.79
CS5F-05-0300	5/16 x 3	100	41.81	CS5F-10-0300	5/8 x 3	25	181.57
CS5F-05-0400	5/16 x 4	50	65.08	CS5F-12-0200	3/4 x 2	20	223.49
CS5F-06-0012	3/8 x 3/4	100	22.03	CS5F-12-0208	3/4 x 2-1/2	20	261.97
CS5F-06-0100	3/8 x 1	100	25.28	CS5F-12-0300	3/4 x 3	20	295.44
CS5F-06-0108	3/8 x 1-1/2	100	32.54				
CS5F-06-0200	3/8 x 2	100	41.39				
CS5F-06-0208	3/8 x 2-1/2	50	50.73				

## GRADE 8 HEX HEAD CAP SCREWS

Heat Treated - Zinc Plated - Coarse (N.C.) Threads

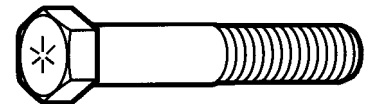

Order No.	Dia. x Lgth.	Pkg.	Per C	Order No.	Dia. x Lgth.	Pkg.	Per C	Order No.	Dia. x Lgth.	Pkg.	Per C
CS8C-04-0012	1/4 x 3/4	50	\$15.17	CS8C-07-0108	7/16 x 1-1/2	25	54.89	CS8C-10-0600	5/8 x 6	10	367.81
CS8C-04-0100	1/4 x 1	50	16.28	CS8C-07-0200	7/16 x 2	25	64.67	CS8C-10-0700	5/8 x 7	10	549.86
CS8C-04-0104	1/4 x 1-1/4	50	17.45	CS8C-07-0208	7/16 x 2-1/2	25	74.56	CS8C-10-0800	5/8 x 8	10	568.10
CS8C-04-0108	1/4 x 1-1/2	50	18.61	CS8C-07-0300	7/16 x 3	25	88.40	CS8C-10-1000	5/8 x 10	10	876.46
CS8C-04-0200	1/4 x 2	50	23.28	CS8C-07-0308	7/16 x 3-1/2	10	115.56	CS8C010-1200	5/8 x 12	10	890.52
CS8C-04-0208	1/4 x 2-1/2	50	27.58	CS8C-07-0400	7/16 x 4	10	121.40	CS8C-12-0108	3/4 x 1-1/2	10	203.91
CS8C-04-0300	1/4 x 3	50	37.23	CS8C-08-0100	1/2 x 1	25	61.56	CS8C-12-0200	3/4 x 2	10	240.30
CS8C-05-0012	5/16 x 3/4	50	17.89	CS8C-08-0108	1/2 x 1-1/2	25	70.34	CS8C-12-0208	3/4 x 2-1/2	10	269.19
CS8C-05-0100	5/16 x 1	50	20.17	CS8C-08-0200	1/2 x 2	25	85.45	CS8C-12-0300	3/4 x 3	10	315.58
CS8C-05-0104	5/16 x 1-1/4	50	22.11	CS8C-08-0208	1/2 x 2-1/2	25	97.79	CS8C-12-0308	3/4 x 3-1/2	10	344.47
CS8C-05-0108	5/16 x 1-1/2	50	24.89	CS8C-08-0300	1/2 x 3	25	117.68	CS8C-12-0400	3/4 x 4	10	380.54
CS8C-05-0200	5/16 x 2	50	36.86	CS8C-08-0308	1/2 x 3-1/2	10	128.34	CS8C-12-0408	3/4 x 4-1/2	10	419.20
CS8C-05-0208	5/16 x 2-1/2	50	40.44	CS8C-08-0400	1/2 x 4	10	140.57	CS8C-12-0500	3/4 x 5	10	455.59
CS8C-05-0300	5/16 x 3	50	45.95	CS8C-08-0408	1/2 x 4-1/2	10	165.29	CS8C-12-0600	3/4 x 6	10	544.21
CS8C-05-0308	5/16 x 3-1/2	25	59.12	CS8C-08-0500	1/2 x 5	10	186.13	CS8C-12-0700	3/4 x 7	10	803.63
CS8C-05-0400	5/16 x 4	25	76.23	CS8C-08-0508	1/2 x 5-1/2	10	235.57	CS8C-12-0800	3/4 x 8	10	862.01
CS8C-06-0012	3/8 x 3/4	50	25.67	CS8C-08-0600	1/2 x 6	10	248.63	CS8C-12-1000	3/4 x 10	10	1231.21
CS8C-06-0100	3/8 x 1	50	28.72	CS8C-08-0700	1/2 x 7	10	515.22	CS8C-14-0308	7/8 x 3-1/2	5	657.83
CS8C-06-0104	3/8 x 1-1/4	50	31.84	CS8C-08-0800	1/2 x 8	10	603.96	CS8C-14-0400	7/8 x 4	5	746.17
CS8C-06-0108	3/8 x 1-1/2	50	36.95	CS8C-10-0108	5/8 x 1-1/2	10	126.40	CS8C-14-0600	7/8 x 6	5	1004.52
CS8C-06-0200	3/8 x 2	50	44.28	CS8C-10-0200	5/8 x 2	10	144.73	CS8C-14-0700	7/8 x 7	5	1251.21
CS8C-06-0208	3/8 x 2-1/2	25	53.67	CS8C-10-0208	5/8 x 2-1/2	10	164.46	CS8C-16-0400	1 x 4	5	910.07
CS8C-06-0300	3/8 x 3	25	60.89	CS8C-10-0300	5/8 x 3	10	188.90	CS8C-16-0408	1 x 4-1/2	5	997.86
CS8C-06-0308	3/8 x 3-1/2	25	74.34	CS8C-10-0308	5/8 x 3-1/2	10	200.57	CS8C-16-0500	1 x 5	5	1080.00
CS8C-06-0400	3/8 x 4	25	97.45	CS8C-10-0400	5/8 x 4	10	226.96	CS8C-16-0600	1 x 6	5	1241.21
CS8C-06-0408	3/8 x 4-1/2	25	119.23	CS8C-10-0408	5/8 x 4-1/2	10	\$249.19	CS8C-16-0700	1 x 7	5	1512.90
CS8C-06-0500	3/8 x 5	25	124.57	CS8C-10-0500	5/8 x 5	10	265.58	CS8C-16-0800	1 x 8	5	1711.25
CS8C-06-0600	3/8 x 6	25	\$172.44	CS8C-10-0508	5/8 x 5-1/2	10	330.86	CS8C-16-1000	1 x 10	5	2150.20

Dealer Schedule: This Page: Full Pkg.....304 Broken Pkg.....102

*Centralize with Central Supply & Rubber Co.*

**Order Online at: [www.CentralSupplyandRubber.com](http://www.CentralSupplyandRubber.com)**



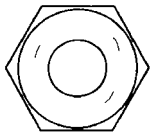

**Hex Nuts**

**GRADE 5  
&  
GRADE 8**

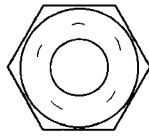

**N.C. Coarse - Zinc Plated**

Gr. 5 No.	Gr. 8 No.	Dia.	Pkg.	Gr. 5 Per C	Gr. 8 Per C
HN5C-04 ...	HN8C-04	1/4"	100	\$4.31	\$9.33
HN5C-05 ...	HN8C-05	5/16"	100	7.18	12.95
HN5C-06 ...	HN8C-06	3/8"	100	9.45	17.61
HN5C-07 ...	HN8C-07	7/16"	50	17.56	30.56
HN5C-08 ...	HN8C-08	1/2"	50	20.73	39.89
HN5C-09 ...		9/16"	25	48.77	N.A.
HN5C-10 ...	HN8C-10	5/8"	25	49.95	71.12
HN5C-12 ...	HN8C-12	3/4"	20	59.03	106.70
HN5C-14 ...	HN8C-14	7/8"	15	96.85	173.39
HN5C-16 ...	HN8C-16	1"	10	153.95	306.99

Dealer Schedule: Full Package ..... 304  
Broken Package ..... 102

**JAM NUTS N.C. & N.F. Thread**

(THIN HEX NUTS) ZINC PLATED



Apply where extra thin nut is required. Also used in conjunction with regular nut when locking action is needed. Jam nut is applied first, with regular nut following. Threads per inch same as standard nuts.

Coarse	Fine	Size	Thickness	Pkg.	Per C
JNC-04	JNF-04	1/4"	5/16"	100	\$5.47
JNC-05	JNF-05	5/16"	9/16"	100	8.10
JNC-06	JNF-06	3/8"	7/32"	100	10.44
JNC-07	JNF-07	7/16"	1/4"	50	18.07
JNC-08	JNF-08	1/2"	5/16"	50	24.27
JNC-10	JNF-10	5/8"	3/8"	25	43.61
JNC-12	JNF-12	3/4"	27/64"	20	83.35
JNC-14	JNF-14	7/8"	31/64"	15	108.36
JNC-16	JNF-16	1"	35/64"	10	158.70
	JNF-18	1-1/8"		10	386.00

Dealer Schedule:

Full Package ..... N.C. .... 304      N.F. .... 203  
Broken Package ..... N.C. .... 203      N.F. .... 102

**TWO-WAY LOCK NUTS**

Coarse & Fine - Zinc Plated



Coarse	Fine	Dia.	Pkg.	Per C
LNT-04	LNTF-04	1/4"	100	\$8.69
LNT-05	LNTF-05	5/16"	100	11.06
LNT-06	LNTF-06	3/8"	100	14.59
LNT-07	LNTF-07	7/16"	50	23.37
LNT-08	LNTF-08	1/2"	50	28.07
LNT-09		9/16"	25	54.33
LNT-10	LNTF-10	5/8"	25	62.94
LNT-12	LNTF-12	3/4"	20	124.83
LNT-14	LNTF-14	7/8"	15	196.24
LNT-16	LNTF-16	1"	10	291.87

Dealer Schedule: Full Pkg. (Coarse) ..... 304  
Broken Pkg. (Coarse) ..... 102  
Full Pkg. (Fine) ..... 102  
Broken Pkg. (Fine) ..... 201

**STANDARD HEX NUTS**

U.S.S. COARSE---S.A.E. FINE  
(Grade 2 - Zinc Plated)

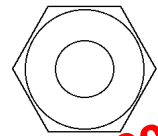

USS No.	SAE No.	Dia.	Pkg.	Coarse Per C	Fine Per C
HN2C-04 ...	HN2F-04	1/4"	100	\$2.61	\$3.39
HN2C-05 ...	HN2F-05	5/16"	100	4.14	4.94
HN2C-06 ...	HN2F-06	3/8"	100	5.72	6.61
HN2C-07 ...	HN2F-07	7/16"	50	11.50	12.61
HN2C-08 ...	HN2F-08	1/2"	50	13.78	15.67
HN2C-09 ...	HN2F-09	9/16"	25	23.22	25.00
HN2C-10 ...	HN2F-10	5/8"	25	28.45	30.67
HN2C-12 ...	HN2F-12	3/4"	20	45.70	52.09
HN2C-14 ...	HN2F-14	7/8"	15	72.23	84.08
HN2C-16 ...	HN2F-16	1"	10	123.34	141.68
HN2C-18 ...	HN2F-18	1-1/8"	10	201.41	236.96
HN2C-20 ...	HN2F-20	1-1/4"	10	272.24	312.80
HN2C-24		1-1/2"	5	608.38	N.A.

Dealer Schedule:

Coarse: Full Pkg.....304 Broken Pkg.....102  
Fine: Full Pkg.....203 Broken Pkg.....251

**10 lb. Cartons  
Standard Hex Nuts**

N.C. Coarse - Zinc Plated



No.	Size	Approx. Qty.	Per Ctn
HNB-04	1/4"-20	304	\$31.69
HNB-05	5/16"-18	304	31.69
HNB-06	3/8"-16	633	31.69
HNB-07	1/2"-14	375	31.69
HNB-08	5/8"-13	272	31.69
HNB-10	7/8"-11	137	31.69
HNB-12	1"-10	87	31.69
HNB-14	1-1/8"-9	53	31.69
HNB-16	1-1/2"-8	36	31.69

Dealer Schedule.....304

**NYLON INSERT  
LOCK NUTS**

Zinc Plated Coarse & Fine



Coarse	Fine	Dia.	Pkg.	Per C
LNC-04	LNF-04	1/4"	100	\$8.34
LNC-05	LNF-05	5/16"	100	9.33
LNC-06	LNF-06	3/8"	100	13.59
LNC-07	LNF-07	7/16"	50	16.96
LNC-08	LNF-08	1/2"	50	29.95
LNC-09		9/16"	25	52.33
LNC-10	LNF-10	5/8"	25	58.23
LNC-12	LNF-12	3/4"	20	95.66
LNC-14	LNF-14	7/8"	15	190.03
LNC-16	LNF-16	1"	10	291.87

Dealer Schedule: Full Pkg. (Coarse) ..... 304  
Broken Pkg. (Coarse) ..... 102  
Full Pkg. (Fine) ..... 102  
Broken Pkg. (Fine) ..... 201



**N.C. STEEL WING NUTS**  
N.C. Coarse - Zinc Plated

No.	Size	Pkg.	Per C
WNC-03	3/16" (10-24)	100	\$16.00
WNC-04	1/4"-20	100	17.86
WNC-05	5/16"-18	100	32.48
WNC-06	3/8"-16	100	50.36
WNC-07	7/16"-14	50	91.54
WNC-08	1/2"-13	50	119.25

Dealer Schedule (Full Package).....204  
(Broken Package).....102

**WHIZ LOCK NUTS**  
N.C. Coarse - Zinc Plated



No.	Dia.	Pkg.	Per C
LNW-04	1/4"-20	100	\$7.56
LNW-05	5/16"-18	100	10.65
LNW-06	3/8"-16	100	14.40
LNW-07	1/2"-14	50	33.36
LNW-08	1/2"-13	50	37.87
LNW-10	5/8"-11	25	89.62
LNW-12	3/4"-10	20	137.86

Dealer Schedule: Full Package ..... 304  
Broken Package ..... 102

**CASTLE NUTS**  
N.F. (Fine)  
Plain Finish



No.	Size	Thread	Pkg.	Each
CNF-08	1/2"-20	20	50	\$2.28
CNF-09	9/16"-18	18	25	3.27
CNF-10	5/8"-18	18	25	3.79
CNF-12	3/4"-16	16	20	4.63
CNF-14	7/8"-14	14	15	6.82
CNF-16	1"-14	14	10	9.40
CNF-18	1-1/8"-12	12	10	13.35
CNF-20	1-1/4"-12	12	10	17.90

Dealer Schedule: Full Package ..... 203  
Broken Package ..... 102

**TOP LOCK NUTS**

"C" Type - Coarse - Zinc Plated

Nut can be threaded all the way before a wrench is required. Withstands severe vibration and shock loads.



Order No.	Size	Pkg.	Per C
LNTOP-04	1/4"-20	100	\$8.60
LNTOP-05	5/16"-18	100	12.37
LNTOP-06	3/8"-16	100	17.77
LNTOP-07	7/16"-14	50	24.61
LNTOP-08	1/2"-13	50	38.93
LNTOP-10	5/8"-11	25	85.88
LNTOP-12	3/4"-10	20	146.67
LNTOP-14	7/8"-9	15	170.39
LNTOP-16	1"-8	10	196.10

Dealer Schedule: Full Pkg. .... 304  
Broken Pkg. .... 102

**SLOTTED  
HEX NUTS**

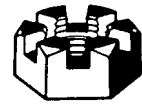

N.C. (Coarse)					
No.	Size	Thread	Pkg.	Each	
SNC-08	1/2"	13	50	\$ .72	
SNC-09	9/16"	12	25	1.40	
SNC-10	5/8"	11	25	1.40	
SNC-12	3/4"	10	20	1.45	
SNC-14	7/8"	9	15	1.82	
SNC-16	1"	8	10	2.75	
SNC-18	1-1/8"	7	10	4.65	
SNC-20	1-1/4"	7	10	5.65	
SNC-24	1-1/2"	6	5	7.77	

N.F. (Fine)					
No.	Size	Thread	Pkg.	Each	
SNF-04	1/4"	28	100	.62	
SNF-05	5/16"	24	100	.65	
SNF-06	3/8"	24	100	.67	
SNF-07	7/16"	24	50	.70	
SNF-08	1/2"	20	50	.72	
SNF-09	9/16"	18	25	1.40	
SNF-10	5/8"	18	25	1.40	
SNF-12	3/4"	16	20	1.45	
SNF-14	7/8"	14	15	1.82	
SNF-16	1"	14	10	2.75	
SNF-18	1-1/8"	12	10	4.65	
SNF-20	1-1/4"	12	10	5.65	

Dealer Schedule: Full Package ..... 304  
Broken Package ..... 102

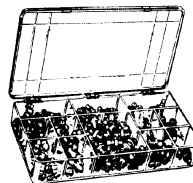

**Slotted Nut Assortment**  
N.F. (Fine)

(Box Size: 19-1/4" x 9-1/8" x 2")

No.	Price
SNF-A	.....
Contains 10 ea. 1/4", 5/16", 3/8", 7/16", 1/2"; 5 ea. 9/16", 5/8", 3/4"; 4 ea. 7/8", 1"; 2 ea. 1-1/8", 1-1/4" ..... Net \$53.84	

**For Fast Shipment  
You Can Rely On  
Central Supply!**

**We ship over 95% of our orders  
the Same Day they are received!**

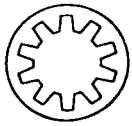

**Internal & External Lock Washers**

Zinc Plated

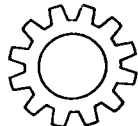

Internal	External	Size	Pkg.	Per C
LWI-04	LWE-04	1/4"	100	\$4.49
LWI-05	LWE-05	5/16"	100	6.27
LWI-06	LWE-06	3/8"	100	8.66
LWI-07	LWE-07	7/16"	100	10.68
LWI-08	LWE-08	1/2"	100	18.47

Dealer Schedule.....304  
**Sold In Full Packages Only!**

**NEW PRICES AS OF 5/5/2018**

**LOCK WASHERS**

Std. Spring Lock Type  
 Zinc Plated



No.	Size	Pkg.	Per C
LW-03	3/16"	100	\$2.33
LW-04	1/4"	100	2.58
LW-05	5/16"	100	3.39
LW-06	3/8"	100	4.34
LW-07	7/16"	50	7.95
LW-08	1/2"	50	10.22
LW-09	9/16"	25	15.45
LW-10	5/8"	25	20.89
LW-12	3/4"	20	30.70
LW-14	7/8"	15	47.04
LW-16	1"	10	69.73
LW-18	1-1/8"	10	110.01
LW-20*	1-1/4"	10	146.12
LW-24	1-1/2"	5	294.62

Full Packages Only Dealer Schedule.....304

**NEW PRICES AS OF 6/27/2019**

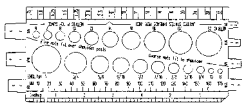

**Nut, Bolt & Thread Gauge**

This gauge does it all. Measure length, size, and threads, in both english & metric with this one easy to use tool!

No.	List
NBT-100	Nut, Bolt & Thread Gauge ..... \$4.99

Dealer Schedule: 5 or more.....152 & 05 Less Than 5.....152



**S.A.E. Flat Washers**

Zinc Plated  
 Sold In Full Packages

No.	Bolt Size	O.D.	I.D.	Pkg. Qty	Per C
SFW-03	#10	.500	.216	100	\$3.33
SFW-04	1/4"	.625	.281	100	4.27
SFW-05	5/16"	.688	.344	100	5.83
SFW-06	3/8"	.812	.406	100	7.30
SFW-07	7/16"	.922	.469	100	11.87
SFW-08	1/2"	1.062	.531	100	14.60
SFW-09	9/16"	1.156	.594	100	27.01
SFW-10	5/8"	1.312	.656	50	16.94
SFW-12	3/4"	1.469	.812	25	23.75
SFW-14	7/8"	1.750	.938	25	31.38
SFW-16	1"	2.000	1.062	25	41.85

Dealer Schedule.....304

**NEW PRICES AS OF 6/27/2019**

**Wrought "Cut" Washers**

U.S.S. - Zinc Plated



No.	Size	I.D.	O.D.	Pkg.	Per C
FWU-03	3/16	1/4	9/16	100	\$2.83

No.	Size	I.D.	O.D.	Approx. Qty Per 5 Lbs	Per Lb.
WW-03	3/16	1/4	9/16	1625	\$4.32
WW-04	1/4	5/16	3/4	670	3.60
WW-05	5/16	3/8	7/8	390	3.60
WW-06	3/8	7/16	1	301	3.41
WW-07	7/16	1/2	1-1/4	185	3.41
WW-08	1/2	9/16	1-3/8	117	3.18
WW-09	9/16	5/8	1-1/2	99	3.11
WW-10	5/8	11/16	1-3/4	59	3.11
WW-12	3/4	13/16	2	41	3.11
WW-14	7/8	15/16	2-1/4	29	3.11
WW-16	1	1-1/16	2-1/2	24	3.11
WW-18	1-1/8	1-1/4	2-3/4	20	3.60
WW-20	1-1/4	1-3/8	3	17	3.60
WW-24	1-1/2	1-5/8	3-1/2	12	3.60

**Large Sized Wrought Washers**

No.	Size	I.D.	O.D.	Each
WW-26	1-5/8	1-3/4	3-3/4	\$3.52
WW-28	1-3/4	1-7/8	4	3.97
WW-30	1-7/8	2	4-1/4	5.39
WW-32	2	2-1/8	4-1/2	5.87

Dealer Schedule.....304

**NEW PRICES AS OF 3/17/2020**



**QUICK REPAIR STEEL OVER LATCH WASHERS**

Order No.	I.D.	O.D.	Each
QRW-12	3/4"	1-3/4"	\$4.80
QRW-14	7/8"	1-7/8"	4.80
QRW-16	1"	2"	4.90
QRW-18	1-1/8"	2-1/8"	5.10
QRW-20	1-1/4"	2-1/4"	5.60
QRW-22	1-3/8"	2-3/8"	5.60
QRW-24	1-1/2"	2-1/2"	5.60
QRW-28	1-3/4"	2-3/4"	5.60
QRW-32	2"	3"	5.60

Dealer Schedule: Bundle Of 10 ..... 304  
 Less Than 10 ..... 102

**STEEL FENDER WASHERS**

Sold In Full Packages Only



No.	Size	O.D.	Gauge	Pkg. Qty.	Per C
FW-316	3/16"	1"	18	100	\$9.43
FW-416	1/4"	1-1/4"	18	100	13.37
FW-516	5/16"	1-1/2"	18	100	18.43
FW-616	3/8"	1-1/2"	16	100	21.36

Dealer Schedule.....304

**NEW PRICES AS OF 6/27/2019**





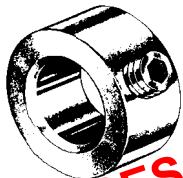

Solid Safety Shaft Collar  
Double Bore  
Plated

Table with columns: No., Shaft Size, Each, No., Shaft Size, Each. Lists various shaft collar sizes and prices.

Dealer Schedule.....304

Steel Key Stock

12 Inch Lengths



SQUARE

Table with columns: No., Size, Price, No., Size, Price. Lists square key stock sizes and prices.

ROUND

Table with columns: No., Size, Price, No., Size, Price. Lists round key stock sizes and prices.

RECTANGULAR

Table with columns: No., Size, Price, No., Size, Price. Lists rectangular key stock sizes and prices.

Key Stock Assortments

Table with columns: No., Description, Price. Lists key stock assortment options and prices.

Key Stock Dealer Schedule.....33/133

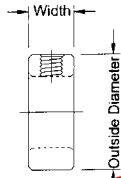
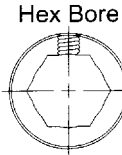

HEX BORE SET COLLARS  
MILD STEEL  
Black Finish

Table with columns: Order No., Bore, O.D., Width, Price. Lists hex bore set collar specifications and prices.

Dealer Schedule.....203

2 Piece Shaft Collar  
Black Oxide Finish  
Socket Cap Screws Installed

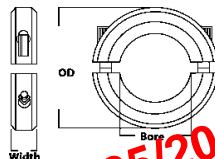

Table with columns: No., Bore, O.D., Width, Screw, List. Lists 2 piece shaft collar specifications and prices.

Dealer Schedule.....304

Split Shaft Collar  
Black Oxide Finish  
Socket Cap Screw Installed

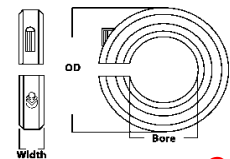

Table with columns: No., Bore, O.D., Width, Screw, List. Lists split shaft collar specifications and prices.

Dealer Schedule.....304

### Set Screws - Square Head - Cup Point

N.C. Coarse Threads  
Plain Finish  
20 Per Package



Order No.	Dia.	Lgth.	Per C
SSS-04-08	1/4	1/2	\$10.73
SSS-04-12	1/4	3/4	14.42
SSS-04-16	1/4	1	20.77
SSS-04-20	1/4	1-1/4	26.40
SSS-05-08	5/16	1/2	16.64
SSS-05-12	5/16	3/4	23.67
SSS-05-16	5/16	1	29.80
SSS-05-20	5/16	1-1/4	30.59
SSS-05-24	5/16	1-1/2	36.05
SSS-06-08	3/8	1/2	30.17
SSS-06-12	3/8	3/4	36.17
SSS-06-16	3/8	1	43.61
SSS-06-20	3/8	1-1/4	46.11
SSS-06-24	3/8	1-1/2	50.73
SSS-07-12	7/16	3/4	47.39
SSS-07-16	7/16	1	58.03
SSS-07-20	7/16	1-1/4	65.07
SSS-07-24	7/16	1-1/2	65.98
SSS-08-12	1/2	3/4	66.53
SSS-08-16	1/2	1	76.67
SSS-08-20	1/2	1-1/4	83.33
SSS-08-24	1/2	1-1/2	104.33
SSS-08-28	1/2	1-3/4	105.20
SSS-08-32	1/2	2	105.95

Dealer Schedule:

Full Package (20).....304 Broken Package.....102



### SOCKET HEAD SET SCREWS

Cup Point - Coarse & Fine - Plain Finish  
25 Per Package

Coarse No.	Fine No.	Dia.	Lgth.	Per C
SSC-03-03	SSF-03-03	No. 10	3/16	\$6.55
SSC-03-04	SSF-03-04	No. 10	1/4	6.55
SSC-03-06	SSF-03-06	No. 10	3/8	7.02
SSC-03-08	SSF-03-08	No. 10	1/2	10.35
SSC-03-20		No. 10	1-1/4	26.08
SSC-04-04	SSF-04-04	1/4	1/4	7.14
SSC-04-05	SSF-04-05	1/4	5/16	7.49
SSC-04-06	SSF-04-06	1/4	3/8	7.55
SSC-04-08	SSF-04-08	1/4	1/2	11.70
SSC-04-10		1/4	5/8	18.92
SSC-04-12		1/4	3/4	12.69
SSC-04-16		1/4	1	16.26
SSC-05-05	SSF-05-05	5/16	5/16	10.42
SSC-05-06	SSF-05-06	5/16	3/8	10.65
SSC-05-08	SSF-05-08	5/16	1/2	11.41
SSC-05-10		5/16	5/8	15.27
SSC-05-12	SSF-05-12	5/16	3/4	22.70
SSC-05-16		5/16	1	20.88
SSC-06-06	SSF-06-06	3/8	3/8	15.84
SSC-06-08	SSF-06-08	3/8	1/2	18.97
SSC-06-10	SSF-06-10	3/8	5/8	20.86
SSC-06-12		3/8	3/4	20.70
SSC-06-16		3/8	1	28.26
SSC-07-07		7/16	7/16	32.76
SSC-07-08		7/16	1/2	36.86
SSC-07-12		7/16	3/4	52.65
SSC-07-16		7/16	1	61.50
SSC-08-08		1/2	1/2	32.18
SSC-08-10		1/2	5/8	40.66
SSC-08-12	SSF-08-12	1/2	3/4	45.60
SSC-08-16	SSF-08-16	1/2	1	51.67
SSC-10-10		5/8	5/8	170.82

Dealer Schedule:

N.C. Coarse		N.F. Fine	
Full Package	304	Full Package	203
Broken Package	102	Broken Package	101

### Square Head Set Screw Assortment

N.C. Coarse Threads

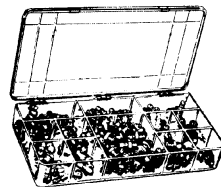

Square Head Set Screw Assortment consisting of 18 different sizes. Packaged in a transparent plastic box with heavy duty hinges and snap-tight lid.

Box size 8-1/2 x 4-3/4 x 1-1/2 inches.

Qty.	Size	Qty.	Size
10	1/4"-20 x 1/2"	5	3/8"-16 x 3/4"
10	1/4"-20 x 3/4"	5	3/8"-16 x 1"
10	1/4"-20 x 1"	2	3/8"-16 x 1-1/4"
5	1/4"-20 x 1-1/4"	5	7/16"-14 x 3/4"
10	5/16"-18 x 1/2"	5	7/16"-14 x 1"
10	5/16"-18 x 3/4"	2	7/16"-14 x 1-1/4"
5	5/16"-18 x 1"	2	1/2"-13 x 3/4"
5	5/16"-18 x 1-1/4"	2	1/2"-13 x 1"
10	3/8"-16 x 1/2"	1	1/2"-13 x 1-1/4"

No.	Description	Price
SSS-A	Square Head Set Screw Assortment ...	\$29.90

Dealer Schedule.....304



### S.A.E. Socket Set Screw Assortment

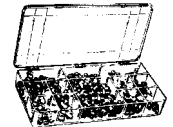

160 N.F. Socket Set Screws consisting of 17 different sizes. Packaged in a transparent plastic box with heavy duty hinges and snap-tight lid. Box size 8-1/2 x 4-3/4 x 1-1/2 inches.

Qty.	Size	Qty.	Size
10	#10-32 x 3/16"	10	5/16"-24 x 3/8"
10	#10-32 x 1/4"	10	5/16"-24 x 1/2"
10	#10-32 x 3/8"	10	5/16"-24 x 3/4"
10	#10-32 x 1/2"	10	3/8"-24 x 3/8"
10	1/4"-28 x 1/4"	10	3/8"-24 x 1/2"
10	1/4"-28 x 5/16"	10	3/8"-24 x 5/8"
10	1/4"-28 x 3/8"	5	1/2"-20 x 3/4"
10	1/4"-28 x 1/2"	5	1/2"-20 x 1"
10	5/16"-24 x 5/16"		

No.	Description	Price
SSF-A	N.F. Socket Hd. Set Screw Ass't	\$28.75

Dealer Schedule.....304

**SOCKET SCREW KEYS**



**SHORT & LONG ARM**  
(Please specify short arm or long arm when ordering)

Fits Set	Pkg.	Fits Cap	#HK- Short Per C	#HKL- Long Per C
Key Dia. .050	#3 & 4	20	#0 \$47.00	N/A
1/16	#5 & 6	20	#1 13.24	\$26.05
5/64	#8	20	#2 & 3 13.63	26.05
3/32	#10	20	#4 & 5 17.32	28.25
7/64		20	#6 19.55	32.95
1/8	1/4"	20	38.39	52.50
9/64"		20	#8 N/A	35.95
5/32	5/16"	20	#10 41.25	63.00
3/16	3/8"	20	1/4" 50.00	63.00
7/32	7/16"	10	70.00	78.95
1/4	1/2"	10	5/16" 80.00	114.95
5/16	5/8"	8	3/8" 169.00	190.00
3/8	3/4"	5	7/16 & 1/2" 307.00	367.00
1/2	7/8"	3	5/8" 640.00	N/A

Dealer Schedule: Full Package ..... 304  
Broken Package ..... 102

**N.C. Socket Set Screw Assortment**

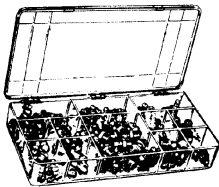

**Hex Socket - Cup Point**

150 N.C. Socket Head Set Screws consisting of 18 different sizes in a transparent plastic box with heavy duty hinges and snap-tight lid.  
Box size 8-1/2 x 4-3/4 x 1-1/2 in.

Qty.	Size	Qty.	Size
10	1/4"-20 x 1/4"	10	3/8"-16 x 3/8"
10	1/4"-20 x 5/16"	10	3/8"-16 x 1/2"
10	1/4"-20 x 3/8"	10	3/8"-16 x 5/8"
10	1/4"-20 x 1/2"	5	3/8"-16 x 3/4"
10	1/4"-20 x 3/4"	5	7/16"-14 x 1/2"
10	5/16"-18 x 5/16"	5	7/16"-14 x 3/4"
10	5/16"-18 x 3/8"	5	1/2"-13 x 1/2"
10	5/16"-18 x 1/2"	5	1/2"-13 x 3/4"
10	5/16"-18 x 3/4"	5	1/2"-13 x 1"

No. Description Price  
SSC-A ..... Socket Head Set Screw Assortment ..... \$29.95  
Dealer Schedule.....304

ALL PRICES SUBJECT TO CHANGE WITHOUT NOTICE.

**Socket Head Cap Screws**

(N.C. - Plain Finish)

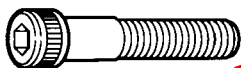

Dealer Schedule.....  
Full Package...304  
Broken Package...102

Order No.	Dia. x Lgth.	Pkg.	Per C
SCS-1024-0006	10-24 x 3/8	25	\$15.01
SCS-1024-0008	10-24 x 1/2	25	15.94
SCS-1024-0012	10-24 x 3/4	25	18.56
SCS-1024-0100	10-24 x 1	25	20.98
SCS-1024-0104	10-24 x 1-1/4	25	24.24
SCS-1024-0108	10-24 x 1-1/2	25	26.10
SCS-4020-0008	1/4 x 1/2	25	18.56
SCS-4020-0012	1/4 x 3/4	25	20.02
SCS-4020-0100	1/4 x 1	25	24.44
SCS-4020-0104	1/4 x 1-1/4	25	25.97
SCS-4020-0108	1/4 x 1-1/2	25	26.33
SCS-4020-0200	1/4 x 2	25	33.93

**BONDHUS FOLDING HEX KEY WRENCH SETS (9 Pc.)**



#14589 Sizes 5/64, 3/32, 7/64, 1/8, 9/64, 5/32, 3/16, 7/32, 1/4  
#14591 Sizes .050, 1/16, 5/64, 3/32, 7/64, 1/8, 9/64, 5/32, 3/16  
#14592 Sizes 1.5, 2, 2.5, 3, 4, 5, 6

Each  
HK-14589 .... Folding Metal Hex Key Set, 9 Pc. .... \$8.87  
HK-14591 .... Folding Metal Hex Key Set, 9 Pc. .... 7.03  
HK-14592 .... Folding METRIC Hex Key Set, 7 Pc. .. 7.29

Dealer Schedule.....152

**BONDHUS FOLDING TORX WRENCH SET (7 Pc.)**

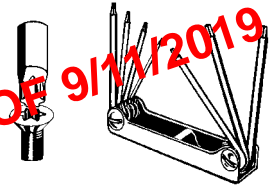

7 Pieces, in the following sizes:  
T10, T15, T20, T25, T27, T30, T40

Each  
HK-14534 .... Folding Torx Wrench Set, 7 pc. .... \$17.29

Dealer Schedule.....152

**BONDHUS ProHold Balldriver Set**

(Plastic Holder Clam Shell)



Hold screw tight over time. ProHold button is non-magnetic. Allows for maximum torque without distortion of button. Made with Titanium High Torque Steel. Sizes: .050 - 3/8"



Try it once!  
You'll love it.

Each  
HK-74937 ..... PROHOLD Balldriver Set, 13 pc. .... \$38.15

Dealer Schedule.....152

**Hex Key Wrench Sets**

(Plastic Holder Clam Shell)

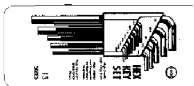

HK13 Sizes: .050, 1/16, 5/64, 3/32, 7/64, 1/8, 9/64, 5/32, 3/16, 1/4, 5/16, and 3/8".

12299 Sizes: 1.5, 2, 2.5, 3, 4, 5, 6, 8, 10mm.

(In Vinyl Pouch)

HK7S Sizes: 5/64, 3/32, 1/8, 5/32, 3/16, 7/32, 1/4"

Each  
GN-HK13L... Long Hex Wrench Set, 13 pc. .... \$7.95  
GN-HK13S .. Short Hex Wrench Set, 13 pc. .... 5.45  
GN-HK7S .... Hex Key Wrench Set, 7 pc ..... 2.98  
HK-12299 .... Metric Hex Wrench Set, 9 pc. .... 10.73

Dealer Schedule..... 152

**NEW PRICES AS OF 9/16/2019**

**NEW PRICES AS OF 9/11/2019**

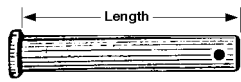

## CLEVIS AND CORN PICKER PINS

Sold Only In Packages Of 10 each

Order No.	Dia. x Lgth.	Per C	Order No.	Dia. x Lgth.	Per C	Order No.	Dia. x Lgth.	Per C
PP-03-012	3/16 x 3/4	\$16.63	PP-05-112	5/16 x 1-3/4	\$32.69	PP-07-100	7/16 x 1	\$50.02
PP-03-100	3/16 x 1	17.30	PP-05-114	5/16 x 1-7/8	34.38	PP-07-104	7/16 x 1-1/4	50.78
PP-03-104	3/16 x 1-1/4	17.84	PP-05-200	5/16 x 2	36.48	PP-07-108	7/16 x 1-1/2	53.90
PP-03-108	3/16 x 1-1/2	18.32	PP-05-204	5/16 x 2-1/4	39.88	PP-07-112	7/16 x 1-3/4	58.86
PP-03-112	3/16 x 1-3/4	19.81	PP-05-206	5/16 x 2-3/8	41.75	PP-07-200	7/16 x 2	61.22
PP-03-200	3/16 x 2	21.69	PP-05-208	5/16 x 2-1/2	42.61	PP-07-204	7/16 x 2-1/4	65.25
PP-03-208	3/16 x 2-1/2	25.34	PP-05-212	5/16 x 2-3/4	45.09	PP-07-208	7/16 x 2-1/2	69.64
PP-04-012	1/4 x 3/4	17.39	PP-05-214	5/16 x 2-7/8	46.78	PP-07-300	7/16 x 3	80.84
PP-04-100	1/4 x 1	18.48	PP-05-300	5/16 x 3	49.54	PP-07-308	7/16 x 3-1/2	85.95
PP-04-104	1/4 x 1-1/4	19.84	PP-05-400	5/16 x 4	65.67	PP-07-400	7/16 x 4	93.94
PP-04-106	1/4 x 1-3/8	21.24	PP-06-100	3/8 x 1	40.99	PP-08-100	1/2 x 1	63.85
PP-04-108	1/4 x 1-1/2	21.97	PP-06-104	3/8 x 1-1/4	42.74	PP-08-104	1/2 x 1-1/4	63.85
PP-04-110	1/4 x 1-5/8	23.18	PP-06-108	3/8 x 1-1/2	46.52	PP-08-108	1/2 x 1-1/2	69.13
PP-04-112	1/4 x 1-3/4	24.04	PP-06-110	3/8 x 1-5/8	48.15	PP-08-112	1/2 x 1-3/4	72.06
PP-04-114	1/4 x 1-7/8	25.41	PP-06-112	3/8 x 1-3/4	49.54	PP-08-200	1/2 x 2	75.30
PP-04-200	1/4 x 2	26.08	PP-06-114	3/8 x 1-7/8	51.10	PP-08-204	1/2 x 2-1/4	80.58
PP-04-204	1/4 x 2-1/4	27.86	PP-06-200	3/8 x 2	53.52	PP-08-208	1/2 x 2-1/2	89.39
PP-04-208	1/4 x 2-1/2	29.89	PP-06-204	3/8 x 2-1/4	56.25	PP-08-212	1/2 x 2-3/4	94.73
PP-04-212	1/4 x 2-3/4	32.02	PP-06-206	3/8 x 2-3/8	59.05	PP-08-300	1/2 x 3	98.13
PP-04-300	1/4 x 3	33.23	PP-06-208	3/8 x 2-1/2	60.80	PP-08-308	1/2 x 3-1/2	114.70
PP-04-400	1/4 x 4	47.25	PP-06-210	3/8 x 2-5/8	61.69	PP-08-400	1/2 x 4	123.80
PP-05-100	5/16 x 1	23.02	PP-06-212	3/8 x 2-3/4	64.49	PP-10-108	5/8 x 1-1/2	97.37
PP-05-103	5/16 x 1-3/16	24.90	PP-06-300	3/8 x 3	68.97	PP-10-112	5/8 x 1-3/4	108.53
PP-05-104	5/16 x 1-1/4	26.27	PP-06-308	3/8 x 3-1/2	79.21	PP-10-200	5/8 x 2	120.65
PP-05-106	5/16 x 1-3/8	27.83	PP-06-400	3/8 x 4	87.39	PP-10-208	5/8 x 2-1/2	141.92
PP-05-108	5/16 x 1-1/2	29.19				PP-10-300	5/8 x 3	163.13
						PP-10-308	5/8 x 3-1/2	186.83

Dealer Schedule: 10 of a size.....152  
30 or more of a size.....203

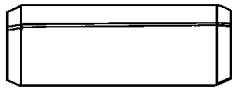

## COILED SPRING PINS

Sold In Packages Of 10 Each Only!  
Standard Medium Duty - Plain Oil Finish

Order No.	Dia. x Lgth.	Per C	Order No.	Dia. x Lgth.	Per C
SPR-116	1/8 x 1	\$13.26	SPR-273	1/4 x 1-1/4	\$39.13
SPR-120	1/8 x 1-1/4	14.82	SPR-277	1/4 x 1-1/2	43.23
SPR-124	1/8 x 1-1/2	17.82	SPR-281	1/4 x 1-3/4	49.38
SPR-128	1/8 x 1-3/4	34.95	SPR-285	1/4 x 2	51.51
SPR-132	1/8 x 2	36.95	SPR-287	1/4 x 2-1/4	55.11
SPR-195	3/16 x 1	23.73	SPR-289	1/4 x 2-1/2	79.30
SPR-199	3/16 x 1-1/4	26.61	SPR-309	5/16 x 1	47.64
SPR-203	3/16 x 1-1/2	29.49	SPR-311	5/16 x 1-1/4	56.64
SPR-207	3/16 x 1-3/4	35.37	SPR-315	5/16 x 1-1/2	69.21
SPR-211	3/16 x 2	39.96	SPR-319	5/16 x 1-3/4	79.54
SPR-213	3/16 x 2-1/4	40.38	SPR-323	5/16 x 2	84.42
SPR-215	3/16 x 2-1/2	41.50	SPR-325	5/16 x 2-1/4	98.95
SPR-269	1/4 x 1	34.32	SPR-327	5/16 x 2-1/2	108.70

Dealer Schedule.....33/133

Order No.	Size	No.	Price
25000	1/16"	1	\$5.90
25001	5/64"	2	6.20
25002	3/32"	3	6.60
25003	1/8"	4	6.80
25004	5/32"	5	7.65
25005	3/16"	6	7.81
25006	7/32"	7	9.00
25007	1/4"	8	10.15
25008	5/16"	9	11.11
25009	3/8"	10	12.12
25010	7/16"	11	13.76
25011	1/2"	12	15.46
62254	Set (No. 1 to 12 inclusive) Plastic Kit		123.31
62258	Same as 62254 but in wood display box		157.75
62250	Set (No. 4 to 09 inclusive) Plastic Kit		60.15

Dealer Schedule.....203

## MAYHEW PILOT PUNCHES

Coiled Spring Pin/Expan Pin Extractors

Designed to speed up pin removal safely, to center perfectly over pin, eliminate damage to pin wall or hole, and to drive pin completely thru hole without sticking punch.

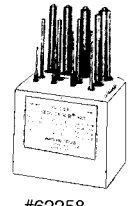
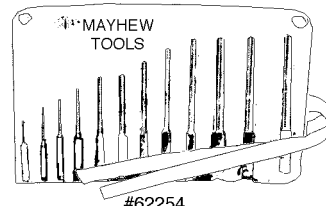
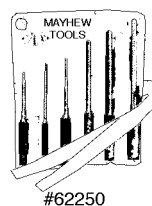

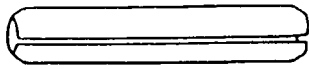

# EXPAN PINS

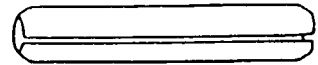

Sold In Packages of 10 Only - Plated

Dia. x Lgth.	Per C	Dia. x Lgth.	Per C	Dia. x Lgth.	Per C	Dia. x Lgth.	Per C	Dia. x Lgth.	Per C
1/16 x 5/8	\$4.10	1/8 x 2	\$11.10	7/32 x 3/4	\$13.50	1/4 x 1-7/8	\$22.60	3/8 x 1-3/4	\$59.90
1/16 x 3/4	4.80	5/32 x 5/8	6.40	7/32 x 7/8	13.00	1/4 x 2	29.10	3/8 x 2	78.50
1/16 x 1	4.20	5/32 x 3/4	6.90	7/32 x 1	15.00	1/4 x 2-1/4	29.40	3/8 x 2-1/4	78.90
5/64 x 1/2	4.00	5/32 x 7/8	8.20	7/32 x 1-1/8	16.40	1/4 x 2-1/2	36.80	3/8 x 2-1/2	80.00
5/64 x 5/8	4.20	5/32 x 1	8.20	7/32 x 1-1/4	18.90	1/4 x 3	45.80	3/8 x 2-3/4	82.40
5/64 x 3/4	4.40	5/32 x 1-1/8	8.90	7/32 x 1-3/8	18.70	5/16 x 1	20.40	3/8 x 3	89.30
5/64 x 1	5.10	5/32 x 1-1/4	9.30	7/32 x 1-1/2	19.90	5/16 x 1-1/8	21.20	3/8 x 3-1/4	109.70
3/32 x 1/2	4.00	5/32 x 1-3/8	10.20	7/32 x 1-5/8	22.00	5/16 x 1-1/4	25.60	3/8 x 3-1/2	110.00
3/32 x 5/8	4.40	5/32 x 1-1/2	10.70	7/32 x 1-3/4	24.60	5/16 x 1-1/2	28.10	7/16 x 1	72.90
3/32 x 3/4	4.80	5/32 x 1-3/4	12.00	7/32 x 1-7/8	24.60	5/16 x 1-3/8	30.00	7/16 x 1-1/4	74.00
3/32 x 1	5.70	5/32 x 2	13.30	7/32 x 2	28.80	5/16 x 1-1/2	32.00	7/16 x 1-1/2	78.50
3/32 x 1-1/8	5.90	3/16 x 3/4	9.40	7/32 x 2-1/4	29.50	5/16 x 1-3/4	35.80	7/16 x 1-3/4	89.50
3/32 x 1-1/4	6.40	3/16 x 7/8	9.50	7/32 x 2-1/2	30.70	5/16 x 2	42.10	7/16 x 2	89.90
3/32 x 1-3/8	6.90	3/16 x 1	11.40	7/32 x 2-3/4	34.40	5/16 x 2-1/4	47.00	7/16 x 2-1/2	105.80
3/32 x 1-1/2	7.20	3/16 x 1-1/8	10.40	7/32 x 3	36.50	5/16 x 2-1/2	51.50	7/16 x 2-3/4	123.20
1/8 x 1/2	5.50	3/16 x 1-1/4	11.50	1/4 x 1/2	13.10	5/16 x 2-3/4	60.70	7/16 x 3	126.00
1/8 x 5/8	5.90	3/16 x 1-3/8	12.20	1/4 x 3/4	13.10	5/16 x 3	70.60	1/2 x 1	78.40
1/8 x 3/4	6.50	3/16 x 1-1/2	12.80	1/4 x 7/8	13.10	5/16 x 3-1/4	75.70	1/2 x 1-1/4	78.40
1/8 x 7/8	6.50	3/16 x 1-5/8	15.10	1/4 x 1	16.70	5/16 x 3-1/2	76.80	1/2 x 1-1/2	80.50
1/8 x 1	8.00	3/16 x 1-3/4	15.20	1/4 x 1-1/8	16.80	5/16 x 3-3/4	80.30	1/2 x 1-3/4	101.20
1/8 x 1-1/8	7.50	3/16 x 1-7/8	15.60	1/4 x 1-1/4	18.20	3/8 x 1	34.70	1/2 x 2	101.50
1/8 x 1-1/4	8.10	3/16 x 2	16.80	1/4 x 1-3/8	20.00	3/8 x 1-1/4	40.80	1/2 x 2-1/4	109.10
1/8 x 1-3/8	8.70	3/16 x 2-1/4	18.70	1/4 x 1-1/2	22.40	3/8 x 1-3/8	53.60	1/2 x 2-1/2	123.10
1/8 x 1-1/2	9.10	3/16 x 2-1/2	19.80	1/4 x 1-5/8	22.70	3/8 x 1-1/2	45.90	1/2 x 2-3/4	143.80
1/8 x 1-3/4	10.00	7/32 x 5/8	12.10	1/4 x 1-3/4	24.50	3/8 x 1-5/8	62.50	1/2 x 3	143.90

NEW PRICES AS OF 2/19/2021

Dealer Schedule: Packs of 10 Only.....33/133

Order Number = EP(Dia)-(Lgth) Example: EP38-214 = 3/8"x2-1/4"

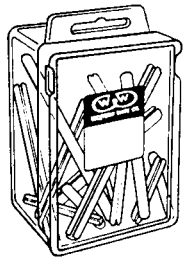

## EXPAN PIN ASSORTMENT

A compact low cost assortment of carbon steel plated spring pins in the most commonly used sizes.

No. Price  
AGR-4018 . Spring Pin Assortment . \$12.90

Dealer Schedule.....33/133

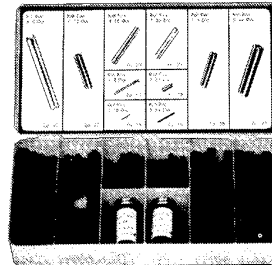

## Expans Pin Assortment #300-10

Contains 300 pieces. Dia.: 1/16, 5/64, 3/32, 1/8, 5/32, 3/16, 7/32, 1/4, 5/16, 3/8. - Four Popular lengths of each diameter.

Dealer Net.....\$33.00

## ROLL PIN MATING

Diam.	Fits Into
5/64	1/8
3/32	5/32
1/8	7/32
5/32	1/4
3/16	5/16
7/32	3/8
5/16	1/2

**Centralize  
with  
Central!  
1-800-444-8666**

## Clevis / Picker Pin Assortment



320 total pieces in 32 sizes, packaged in a 3"x18"x12" heavy-duty metal case. Catched lid and scooped compartments for easy parts removal.

Order No. Net  
PPA-320 ..... Picker Pin Ass't.... \$108.41

DUE TO  
MARKET  
CONDITIONS,  
ALL PRICES  
ARE SUBJECT  
TO CHANGE  
WITHOUT  
NOTICE!

## E-Clip Assortment (300 Clips Total)

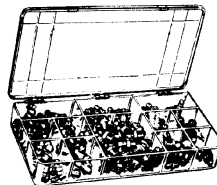

Consisting of 12 different sizes in a transparent plastic box with heavy duty hinges and snap-tight lid. Box size 8-1/2 x 4-3/4 x 1-1/2 in.

No. Each  
EA300 ... E Clip Ass't..... \$39.00

Dealer Schedule.....152



## E-Clips (Packages Of 10)

No.	Size	Qty. In Ass't.	Pkg. Price
E06	1/16"	0	\$1.40
E12	1/8"	40	1.40
E18	3/16"	30	1.40
E21	7/32"	30	1.40
E25	1/4"	30	1.40
E31	5/16"	30	1.60
E37	3/8"	30	1.60
E43	7/16"	20	1.60
E50	1/2"	20	1.60
E62	5/8"	20	2.00
E75	3/4"	20	2.00
E87	7/8"	20	2.00
E98	1"	10	3.25

Dealer Schedule.....152

**FAX TOLL-FREE 1-800-342-7252**

**SNAP RING ASSORTMENTS**

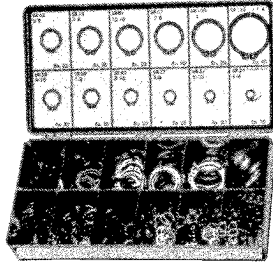

**No 300-12 External Assortment**

Contains 300 snap rings in 12 sizes from 1/4 to 1-1/4 inch in diameter.

Dealer Net ..... \$30.00

**No 150-14 Internal Assortment**

Contains 150 snap rings in 14 sizes from 1/2 to 1-3/4 inch in diameter.

Dealer Net ..... \$31.12

**Woodruff Keys**

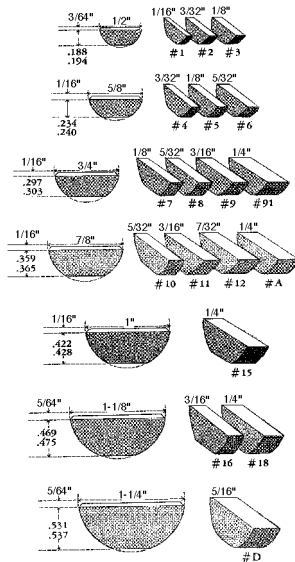

No.	Size	Per C
WK-213	3/8 x 1/8	\$48.13
WK-001	1/2 x 1/16	25.04
WK-002	1/2 x 3/32	25.04
WK-003	1/2 x 1/8	25.04
WK-004	5/8 x 3/32	25.04
WK-005	5/8 x 1/8	25.98
WK-006	5/8 x 5/32	29.72
WK-061	5/8 x 3/16	31.02
WK-007	3/4 x 1/8	33.65
WK-008	3/4 x 5/32	33.69
WK-009	3/4 x 3/16	34.65
WK-091	3/4 x 1/4	40.17
WK-010	7/8 x 5/32	38.92
WK-011	7/8 x 3/16	40.84
WK-012	7/8 x 7/32	51.11
WK-00A	7/8 x 1/4	73.31
WK-013	1 x 3/16	56.44
WK-014	1 x 7/32	73.37
WK-015	1 x 1/4	75.19
WK-00B	1 x 5/16	92.75
WK-152	1 x 3/8	131.00
WK-141	15/16 x 1/4	89.04
WK-016	1-1/8 x 3/16	70.30

**SNAP RING REFILLS (Sold In Full Packages Only!)**

External No.	Size	Pkg.	Each	Internal No.	Size	Pkg.	Each
SRE-00416	1/4	10	\$.16	SRI-00716	7/16	10	\$.20
SRE-00516	5/16	10	.16	SRI-00816	1/2	10	.20
SRE-00616	3/8	10	.16	SRI-00916	9/16	10	.18
SRE-00716	7/16	10	.16	SRI-01016	5/8	10	.18
SRE-00816	1/2	10	.16	SRI-01116	11/16	10	.19
SRE-00916	9/16	10	.16	SRI-01216	3/4	10	.28
SRE-01016	5/8	10	.16	SRI-01316	13/16	10	.28
SRE-01116	11/16	10	.18	SRI-01416	7/8	10	.30
SRE-01216	3/4	10	.18	SRI-01516	15/16	10	.30
SRE-01316	13/16	10	.18	SRI-10000	1	10	.32
SRE-01416	7/8	10	.18	SRI-10116	1-1/16	8	.35
SRE-01516	15/16	10	.18	SRI-10216	1-1/8	8	.35
SRE-10000	1	10	.18	SRI-10316	1-3/16	8	.38
SRE-10216	1-1/8	10	.25	SRI-10416	1-1/4	8	.38
SRE-10316	1-3/16	10	.25	SRI-10516	1-5/16	8	.42
SRE-10416	1-1/4	10	.28	SRI-10616	1-3/8	5	.42
SRE-10516	1-5/16	6	.39	SRI-10716	1-7/16	5	.45
SRE-10616	1-3/8	6	.42	SRI-10816	1-1/2	5	.45
SRE-10716	1-7/16	6	.43	SRI-10916	1-9/16	5	.48
SRE-10816	1-1/2	6	.44	SRI-11016	1-5/8	5	.54
SRE-10916	1-9/16	3	.53	SRI-11116	1-11/16	5	.58
SRE-11016	1-5/8	3	.56	SRI-11216	1-3/4	5	.58
SRE-11116	1-11/16	3	.75	SRI-11316	1-13/16	3	.70
SRE-11216	1-3/4	3	.90	SRI-11416	1-7/8	3	.81
SRE-11316	1-13/16	2	1.09	SRI-11516	1-15/16	3	.90
SRE-11416	1-7/8	2	1.09	SRI-20000	2	2	.95
SRE-11516	1-15/16	2	1.09	SRI-20416	2-1/4	2	1.12
SRE-20000	2	2	1.09	SRI-20616	2-3/8	2	1.71
SRE-20416	2-1/4	2	1.51	SRI-20816	2-1/2	2	1.71
SRE-20616	2-3/8	2	1.70	SRI-21016	2-5/8	2	1.71
SRE-20816	2-1/2	2	1.93	SRI-21216	2-3/4	2	2.58
SRE-21016	2-5/8	2	2.12	SRI-21416	2-7/8	2	2.58
SRE-21216	2-3/4	2	2.12	SRI-30000	3	2	2.58
SRE-21416	2-7/8	2	2.59				
SRE-30000	3	2	2.59				

Dealer Schedule.....152

**RETAINING RING PLIER KIT**



Consists of one external and one internal plier. Two pair each of .035 diam. 90°: .045 diam. straight: .045 diam. 45°: .060 diam. 60° tips.

No.	Price
4440R	Snap Ring Plier Kit ..... \$43.96
4482R	Replaceable Tip Kit ..... 19.87
Dealer Schedule ..... 152	

No.	Size	Per C
WK-017	1-1/8 x 7/32	\$90.26
WK-018	1-1/8 x 1/4	95.95
WK-00C	1-1/8 x 5/16	125.94
WK-019	1-1/4 x 3/16	106.70
WK-020	1-1/4 x 7/32	109.10
WK-021	1-1/4 x 1/4	127.00
WK-00E	1-1/4 x 3/8	194.20
WK-00D	1-1/4 x 5/16	157.72
WK-022	1-3/8 x 1/4	145.50
WK-023	1-3/8 x 5/16	176.90
WK-00F	1-3/8 x 3/8	234.00
WK-024	1-1/2 x 1/4	162.20
WK-025	1-1/2 x 5/16	186.03
WK-00G	1-1/2 x 3/8	304.70
WK-126	2-1/8 x 3/16	153.00
WK-127	2-1/8 x 1/4	163.00
WK-128	2-1/8 x 5/16	192.00
WK-129	2-1/8 x 3/8	226.00
WK-026	2-1/8 x 3/16	128.30
WK-027	2-1/8 x 1/4	223.00
WK-028	2-1/8 x 5/16	237.40
WK-029	2-1/8 x 3/8	260.00

Dealer Schedule:

Pkg. of 10.....405 Broken Pkg.....102

**#WKA-178**

**Woodruff Key Assortment**

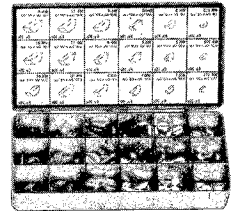

Packaged in transparent plastic box with heavy duty hinges and a snap tight lid. 178 keys, 18 size Box size 8-1/2 x 4-3/4 x 1-1/2 inches.

Qty.	Key No	Qty.	Key No.
10	001	10	091
10	002	10	010
10	003	10	011
10	004	10	012
10	005	10	00A
10	006	10	015
10	007	10	016
10	008	10	018
10	009	8	00D

Assortment.....Dealer Net: \$47.50

**COTTER PIN "AG" ASSORTMENTS**

Packaged in clear boxes and are plated finish



50AG		100AG	
Pieces	Size	Pieces	Size
5	3/32 x 3/4	10	3/32 x 3/4
5	3/32 x 1	10	3/32 x 1
2	3/32 x 1-1/2	4	3/32 x 1-1/2
5	1/8 x 1	10	1/8 x 1
5	1/8 x 1-1/4	10	1/8 x 1-1/4
4	1/8 x 1-1/2	8	1/8 x 1-1/2
2	5/32 x 1-1/2	4	5/32 x 1-1/2
6	3/16 x 1-1/2	10	3/16 x 1
6	3/16 x 2	10	3/16 x 1-1/2
3	1/4 x 1-1/2	8	3/16 x 2
3	1/4 x 2	6	1/4 x 1-1/2
2	5/16 x 2	6	1/4 X 2
2	5/16 x 2-1/2	2	5/16 x 2
		2	5/16 x 2-1/2
50 Total		100 Total	

No.	Price
50AG ..... Cotter Pin Assortment .....	\$6.76
100AG ..... Cotter Pin Assortment .....	10.53
Dealer Schedule.....203	

**EXTERNAL HITCH PIN CLIPS**

General purpose snap-on clip  
Spring steel wire - Clear zinc plated



Order No.	Wire Dia.	Overall Length	Eye I.D.	Fits Pin Groove	Each
HP-414-X	0.125"	2-1/16"	7/16"	25/32"	\$ .26
HP-417-X	0.187"	2-7/8"	7/8"	3/4"	.42

Dealer Schedule.....102

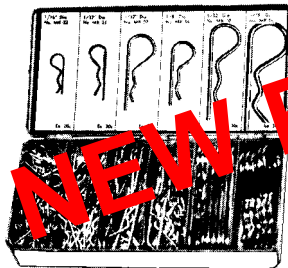

**Central Hitch Pin Clip Assortment #HP-A11**

11 SIZES - - - 185 HAIR PINS

185 Hair Pin Clips consisting of 11 different sizes. Packaged in a transparent plastic box with heavy-duty hinges and snap tight lid. Box size 10-1/2 x 6-1/2 x 1-3/4 inches.

Qty.	No.	Qty.	No.
20	HP-22	20	HP-11
20	HP-17	20	HP-10
20	HP-03	10	HP-06
20	HP-16	10	HP-08
20	HP-07	5	HP-19
20	HP-14		

No.	Price
HP-A11 ..... Hair Pin Assortment .....	\$59.59

Dealer Schedule.....304

**Hammer-Lock Cotter Pins**

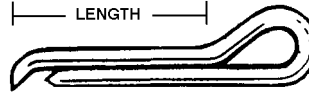

- 
- Order Number=CP(Dia)-(Lgth)
- Example:
- CP332-114 = 3/32"x1-1/4"
- 

Size	Pkg.	Per C	Size	Pkg.	Per C
1/32 x 1/2	100	\$4.29	5/32 x 1-1/2	100	\$9.00
1/16 x 3/4	100	5.23	5/32 x 2	100	10.55
1/16 x 1	100	5.79	5/32 x 2-1/2	100	12.09
1/16 x 1-1/2	100	6.92	5/32 x 3	100	13.67
3/32 x 1/2	100	4.64	3/16 x 1	100	9.04
3/32 x 3/4	100	5.08	3/16 x 1-1/4	100	10.09
3/32 x 1	100	5.37	3/16 x 1-1/2	100	11.09
3/32 x 1-1/4	100	5.97	3/16 x 1-3/4	100	12.12
3/32 x 1-1/2	100	6.45	3/16 x 2	100	13.15
3/32 x 2	100	7.27	3/16 x 2-1/2	100	15.38
7/64 x 3/4	100	5.51	3/16 x 3	100	17.10
7/64 x 1	100	6.15	1/4 x 1-1/2	50	14.92
7/64 x 1-1/4	100	6.75	1/4 x 2	50	17.95
7/64 x 2	100	8.65	1/4 x 2-1/4	50	19.95
1/8 x 3/4	100	5.51	1/4 X 2-1/2	50	21.35
1/8 x 1	100	6.15	1/4 x 3	50	24.75
1/8 x 1-1/4	100	6.75	1/4 X 4	50	35.30
1/8 x 1-1/2	100	7.42	5/16 x 2	50	25.52
1/8 x 2	100	8.65	5/16 x 2-1/4	50	28.69
1/8 x 2-1/2	100	9.90	5/16 x 2-1/2	50	30.21
5/32 x 1	100	7.34	5/16 x 3	10	38.73
5/32 x 1-1/4	100	8.29	5/16 x 3-1/2	10	43.12
			5/16 x 4	10	47.59
			3/8 x 2	10	63.80
			3/8 x 3	10	76.15
			3/8 x 4	10	88.63

Dealer Schedule: Full Boxes Only.....405

**HITCH PIN CLIPS**

(Hair Pins - Zinc Plated)  
Sold In Full Packages Only



No.	Wire Size In.	Fits These Drill Holes	Length	Pkg.	Per C
HP-22	.062	5/64"	1-5/16"	10	\$13.00
HP-17	.080	3/32"	1-9/16"	10	13.50
HP-03	.094	7/64"	1-5/8"	10	12.80
HP-07	.094	7/64"	2-5/16"	10	16.50
HP-14	.094	7/64"	2-1/2"	10	20.70
HP-16	.125	9/64"	1-15/16"	10	22.30
HP-11	.125	9/64"	2-9/16"	5	20.97
HP-10	.148	5/32"	2-15/16"	5	28.28
HP-06	.177	3/16"	3-1/4"	5	43.49
HP-08	.177	3/16"	3-3/4"	5	47.93
HP-19	.243	17/64"	4"	5	110.77
HP-35	.243	17/64"	5-1/8"	5	284.94

Dealer Schedule: Full Packages Only.....304

**NO. HPC-15 HITCH PIN CLIP ASSORTMENT**



Contains 15 cadmium plated pins with wire diam. of 3/32, 1/8, 5/32, and 3/16 in. in various lengths.

No.	Price
HPC-15 .. Hair Pin Ass't .....	\$6.49
Dealer Schedule ..... 203	

NEW PRICES AS OF 3/10/2021

## #934 SPRING CASE ASSORTMENT

128 Springs--40 Sizes

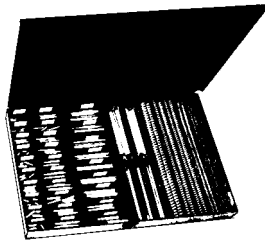

This sturdy case with hinged cover contains 40 different popular zinc plated springs. 116 extension and 12 compression. Each size placed in individual coded compartment.

No.	Price
934 ..... Spring Assortment .....	\$251.60

Dealer Schedule.....152

## Agricultural Extension Spring Assortment

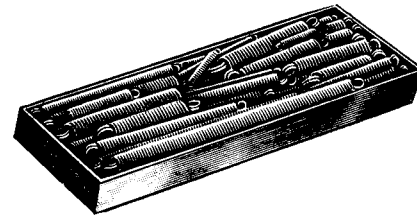

Twenty-five cadmium plated and burnished springs. From 2 to 12 inches in length, 1/4 to 3/4 inches in diameter. Ten springs in this assortment are specially designed for corn planters and check-rows. Weight 3-3/4 lbs.

No.	Price
36-C ..... Extension Spring Assortment .....	\$68.30

Dealer Schedule.....152

## Extension Spring Assortment

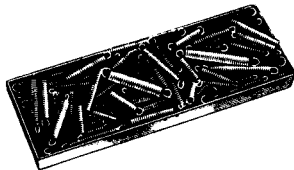

One hundred zinc plated springs, 50 sizes, 2 each from one inch to four inches in length. 3/32 to 7/16 inch in diameter. Weight 1-1/2 lbs.

No.	Price
E-100C ..... Extension Spring Assortment .....	\$72.40

Dealer Schedule.....152

## Compression Spring Assortment

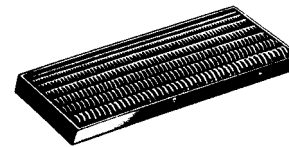

Eight cadmium plated springs from 1/4 to 27/32 inch in diameter, 12 inch in length. Wt. 1-1/4 lbs.

No.	Price
8-C ..... Compression Spring Assortment ..	\$47.90

Dealer Schedule.....152

## GIB HEAD KEYS

Used on power transmission shafts for holding pulleys and gears on tightly.  
1/8" Taper Per Foot - Cold Finish Steel

**SOLD ONLY IN PACKAGES OF 5 EACH**

Order No.	Size	Each	Order No.	Size	Each
GIB-04-100	1/4" x 1"	\$3.93	GIB-06-100	3/8" x 1"	\$4.32
GIB-04-108	1/4" x 1-1/2"	4.16	GIB-06-108	3/8" x 1-1/2"	4.71
GIB-04-200	1/4" x 2"	4.67	GIB-06-200	3/8" x 2"	5.36
GIB-04-208	1/4" x 2-1/2"	4.98	GIB-06-208	3/8" x 2-1/2"	5.74
GIB-04-300	1/4" x 3"	5.10	GIB-06-300	3/8" x 3"	6.24
GIB-05-100	5/16" x 1"	4.27	GIB-08-100	1/2" x 1"	6.02
GIB-05-108	5/16" x 1-1/2"	4.71	GIB-08-108	1/2" x 1-1/2"	6.52
GIB-05-200	5/16" x 2"	5.25	GIB-08-200	1/2" x 2"	6.95
GIB-05-208	5/16" x 2-1/2"	5.39	GIB-08-208	1/2" x 2-1/2"	7.45
GIB-05-300	5/16" x 3"	5.63	GIB-08-300	1/2" x 3"	7.94

Dealer Schedule.....33/133

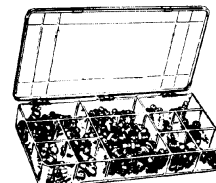

## GIB KEY Assortment (38 Keys Total)

Consisting of 2 each of 19 different sizes, in a transparent poly box with heavy duty hinges and snap-tight lid. Box size 14 x 9 x 2 in.

No.	Net
GIB-A .... Assortment, 38 Keys .....	\$87.95

PRICES SUBJECT TO CHANGE WITHOUT NOTICE.



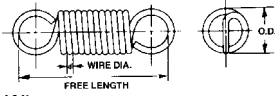

**EXTENSION SPRINGS--ZINC PLATED**

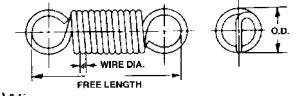

Wire					Wire					Wire				
No.	Ga.	O.D.	Lgth.	Pkg. Each	No.	Ga.	O.D.	Lgth.	Pkg. Each	No.	Ga.	O.D.	Lgth.	Pkg. Each
E00C	.0230	3/16	1	12 \$1.25	E34C*	.0348	3/8	2-3/4	12 \$1.83	V19C	.1055	27/32	6	3 \$5.55
E01C	.0230	3/16	1-1/4	12 1.30	E35C*	.0348	3/8	3	12 1.83	V20C*	.0915	47/64	6	3 5.55
E02C	.0230	3/16	1-1/2	12 1.31	E36C*	.0475	3/8	1-1/2	12 1.50	V21C*	.0800	41/64	6	3 4.74
E03C	.0230	3/16	1-3/4	12 1.32	E37C*	.0475	3/8	1-3/4	12 1.61	V22C*	.0720	37/64	6	3 4.14
E04C	.0230	3/16	2	12 1.42	E38C*	.0475	3/8	2	12 1.63	V23C*	.0625	1/2	6	3 3.51
E05C	.0230	3/16	2-1/4	12 1.43	E39C*	.0475	3/8	2-1/4	12 1.67	V24C*	.0540	7/32	6	6 3.30
E06C	.0230	3/16	2-1/2	12 1.43	E40C*	.0475	3/8	2-1/2	12 1.67	V25C*	.0475	3/8	6	6 3.12
E07C	.0286	1/4	1	12 1.40	E41C*	.0475	3/8	2-3/4	12 2.01	V26C*	.0410	21/64	6	6 2.85
E08C	.0286	1/4	1-1/4	12 1.41	E42C*	.0475	3/8	3	12 2.01	V27C*	.0348	9/32	6	6 2.64
E09C	.0286	1/4	1-1/2	12 1.42	E43C*	.0475	7/16	2-1/2	12 2.01	V28C*	.0317	1/4	6	6 2.64
E10C*	.0286	1/4	1-3/4	12 1.43	E44C*	.0475	7/16	2-3/4	12 2.01	V29C*	.0286	15/64	6	12 2.64
E11C*	.0286	1/4	2	12 1.44	E45C*	.0475	7/16	3	12 2.24	V30C*	.0258	13/64	6	12 2.64
E12C*	.0286	1/4	2-1/4	12 1.45	E46C*	.0475	7/16	3-1/4	12 2.24	V31C	.0230	3/16	6	12 2.64
E13C*	.0286	1/4	2-1/2	12 1.52	E47C*	.0475	7/16	3-1/2	12 2.24	V32C	.0204	5/32	6	12 2.64
E14C*	.0286	5/16	1	12 1.45	E48C*	.0475	7/16	3-3/4	12 2.44	V33C	.0180	9/64	6	12 2.64
E15C*	.0286	5/16	1-1/4	12 1.46	E49C*	.0475	7/16	4	12 2.44	V34C	.0160	1/8	6	12 2.64
E16C*	.0286	5/16	1-1/2	12 1.48	V01C	.1205	31/32	4	3 5.34	V35C	.1205	31/32	8	3 8.53
E17C*	.0286	5/16	1-3/4	12 1.61	V02C	.1055	27/32	4	3 3.51	V36C	.1055	27/32	8	3 8.53
E18C*	.0286	5/16	2	12 1.61	V03C*	.0915	47/64	4	3 3.51	V37C	.0915	47/64	8	3 6.78
E19C*	.0286	5/16	2-1/4	12 1.61	V04C*	.0800	41/64	4	3 3.51	V38C	.0800	41/64	8	3 6.28
E20C*	.0286	5/16	2-1/2	12 1.62	V05C*	.0720	37/64	4	3 3.30	V39C	.0720	37/64	8	3 6.28
E21C*	.0348	5/16	1	12 1.40	V06C*	.0625	1/2	4	3 3.22	V40C	.0625	1/2	8	3 5.55
E22C*	.0348	5/16	1-1/4	12 1.41	V07C*	.0540	7/16	4	6 2.64	V41C	.0540	7/16	8	3 4.92
E23C*	.0348	5/16	1-1/2	12 1.43	V08C*	.0475	3/8	4	6 2.64	V42C	.0475	3/8	8	3 4.32
E24C*	.0348	5/16	1-3/4	12 1.61	V09C*	.0410	21/64	4	6 2.44	V43C	.0410	21/64	8	6 4.32
E25C*	.0348	5/16	2	12 1.61	V10C*	.0348	9/32	4	6 2.31	V44C	.0348	9/32	8	6 4.14
E26C*	.0348	5/16	2-1/4	12 1.61	V11C*	.0317	1/4	4	6 2.31	V45C	.0317	1/4	8	6 4.14
E27C	.0348	5/16	2-1/2	12 1.63	V12C*	.0286	15/64	4	12 2.31	V46C	.0286	15/64	8	6 4.14
E28C*	.0348	3/8	1-1/4	12 1.46	V13C*	.0258	13/64	4	12 1.82	V47C	.0258	13/64	8	12 4.14
E29C*	.0348	3/8	1-1/2	12 1.48	V14C	.0230	3/16	4	12 1.82	V48C	.0230	3/16	8	12 4.14
E30C*	.0348	3/8	1-3/4	12 1.61	V15C	.0204	5/32	4	12 1.82	V49C	.0200	5/32	8	12 4.14
E31C*	.0348	3/8	2	12 1.61	V16C	.0181	9/64	4	12 1.82	V50C	.0180	9/64	8	12 4.14
E32C*	.0348	3/8	2-1/4	12 1.63	V17C	.0162	1/8	4	12 1.82	V51C	.0160	1/8	8	12 4.14
E33C*	.0348	3/8	2-1/2	12 1.65	V18C	.1205	31/32	6	3 5.81					

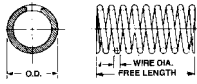

**COMPRESSION SPRINGS--ZINC PLATED**

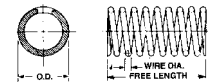

Wire					Wire				
No.	Ga.	O.D.	Lgth.	Pkg. Each	No.	Ga.	O.D.	Lgth.	Pkg. Each
C01C*	.0230	3/16	1-1/4	12 \$1.39	8C11C	.1205	31/32	12	3 \$5.16
C04C*	.0230	3/16	2	12 1.39	8C12C	.1050	27/32	12	3 4.47
C07C*	.0286	1/4	1	12 1.39	8C13C*	.0915	47/64	12	3 4.11
C13C*	.0286	1/4	2-1/2	12 1.75	8C14C*	.0800	41/64	12	3 3.67
C14C*	.0286	5/16	1	12 1.75	8C15C*	.0720	37/64	12	3 3.43
C18C*	.0286	5/16	2	12 1.75	8C16C*	.0625	1/2	12	3 3.43
C21C*	.0348	5/16	1	12 1.75	8C17C	.0540	7/16	12	3 3.43
C28C*	.0348	3/8	1-1/4	12 1.75	8C18C*	.0475	3/8	12	6 3.43
C36C*	.0475	3/8	1-1/2	12 1.75	8C19C	.0410	21/64	12	6 3.43
C38C*	.0475	3/8	2	12 1.75	8C20C*	.0348	9/32	12	6 3.43
C42C*	.0475	3/8	3	12 2.43	8C21C	.0217	1/4	12	12 3.43
C43C*	.0475	7/16	2-1/2	12 2.43	8C22C*	.0286	15/64	12	12 3.43
C45C	.0475	7/16	3	12 2.43	8C23C	.0258	13/64	12	12 3.43
					8C24C	.0230	3/16	12	12 3.43

Note: \* Denotes Spring in #934 Assortment on next page.

**COT SPRINGS-ZINC PLATED**

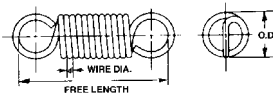

Wire				
No.	Ga.	O.D.	Lgth.	Pkg. Each
G37COT	.1055	11/16	2-3/4	12 \$2.09
G37ACOT	.1055	23/32	1-5/8	12 1.94
G38COT	.0800	1/2	1-23/32	12 1.62
G39COT	.1205	23/32	3-3/8	12 2.28

DEALER SCHEDULE THIS PAGE:

Full Package.....102

Broken Package.....101

PRICES ARE SUBJECT TO CHANGE WITHOUT NOTICE.

## TURNBUCKLES



### Eye To Eye-Galvanized

Order No.	Size	Take-up	Each
TB-11712	3/8"	6"	\$15.70
TB-11716	1/2"	6"	17.63



### Hook To Eye-Galvanized

Order No.	Size	Take-up	Each
TB-11812	3/8"	6"	\$15.70
TB-11816	1/2"	6"	17.63

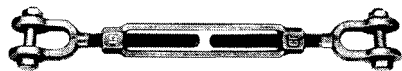

### Jaw To Jaw-Galvanized

Order No.	Size	Take-up	Each
TB-11112	3/8"	6"	\$20.14
TB-11116	1/2"	6"	22.22
TB-11140	3/4"	6"	30.75



### Stub-End-Oil Finish

Order No.	Size	Take-up	Each
TB-10512	3/8"	6"	\$9.08
TB-10516	1/2"	6"	10.60
TB-10528	5/8"	6"	14.46
TB-10540	3/4"	6"	22.50

Dealer Schedule: One ..... 102  
Two Or More ..... 152

## CONTINUOUS STEEL HINGES UNPLATED - EQUAL LEAVES

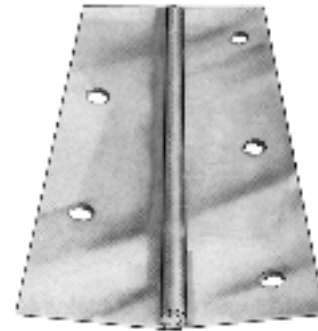

**Sold In 8 Foot Lengths Only Plain finish - No holes**

Order No.	Ga.	Open Width	Pin Dia.	Each
S065032	16	2"	3/16"	\$27.85
S076056	14	3-1/2"	1/4"	42.12

Dealer Schedule: 1 to 3.....203 4 or More.....253

## Sprayon Wire Rope Lubricant



Penetrates pores of gear teeth and wire ropes thru foaming action. Requires no heating, sprays in seconds. Black color aids in determining adequate coverage. Penetrates to core of wire rope minimizing internal friction. Will not become brittle or break down. Withstands extreme pressure loads and severe temperatures. Will not wash off with water or rub off. "Travels" on metal surface, displacing water to give high rust protection.

No.	Each
00201 Cable Lube, 13 oz. Pressurized	\$12.55
Full Case (12)	253 Broken Case ..... 102

**NEW PRICES AS OF 3/11/2019**

**For Same Day Shipment Call  
Central Supply**

**Toll-Free  
1-800-444-8666  
Fax Toll-Free  
1-800-342-7252**

**We Ship  
Over 95%  
Of Our Orders  
The Same Day!**

### Wire Rope Thimbles Galvanized



Hot galvanized with round points and scores. Accurately formed from heavy gauge metal of weight commensurate with the thimble size.

No.	Size	Per C	No.	Size	Per C
87195	3/16	\$49.22	87895	5/8	\$155.87
87295	1/4	53.32	87905	3/4	184.58
87395	5/16	57.43	86915	7/8	422.50
87495	3/8	64.13	86925	1	522.20
87695	1/2	69.73			

Dealer Schedule.....152

**Tired of waiting  
for your shipments?**

***Central Supply***  
*ships over 95% of all  
orders the same day  
they are received!*

**Call 1-800-444-8666**

### Farm Cable Cut To Length For Farmhand Machines

(6x19 wire)

Order No.	Dia.	Length	Each
FCC-05058	5/16"	58'	\$67.34
FCC-06054	3/8"	54'	77.27
FCC-06058	3/8"	58'	83.00

Dealer Schedule: 10 Assorted Cables ..... 152  
Less Than 10 Cables ..... 102

### Cable Clamps Malleable Wire Rope Clips



Standard galvanized. Resistant to corrosion. The threads are clean and the nut will spin on. U-bolt has extra long threads, clean cuts, rounded ends. Perfect fitting nuts, easily started.

No.	Size	Per C	No.	Size	Per C
86090	1/8	\$49.75	86690	1/2	\$149.95
86190	3/16	54.29	86890	5/8	189.26
86290	1/4	71.60	86900	3/4	270.31
86390	5/16	79.56	86910	7/8	393.66
86490	3/8	103.42	86920	1	499.00
86590	7/16	133.34			

Dealer Schedule.....203

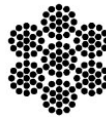

### Galvanized Aircraft Cable



(Minimum 25' Lengths)

No.	Size	Wire	Breaking Strength	Per C/Ft.
GAC-02	1/8"	7x19	2100 lbs.	\$24.68
GAC-03	3/16"	7x19	4700 lbs.	38.92
GAC-04	1/4"	7x19	8200 lbs.	57.26
GAC-05	5/16"	7x19	12500 lbs.	73.14
GAC-06	3/8"	7x19	18000 lbs.	111.30

Dealer Schedule: 500 ft. Lengths ..... 13/133  
250 to 499 ft. Lengths ..... 192  
25 to 249 ft. Lengths ..... 202

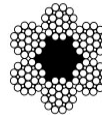

### Farm Cable (Fiber Core)

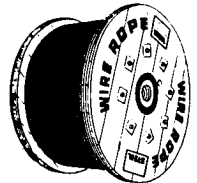

(6x19 wire)

No.	Size	Approx. Wt. Per C/Ft.	Breaking Strength	Per C/Ft.
FC-04	1/4"	10 lbs.	5480 lbs.	\$83.08
FC-05	5/16"	16 lbs.	8520 lbs.	116.10
FC-06	3/8"	23 lbs.	12200 lbs.	143.10
FC-07	7/16"	32 lbs.	16540 lbs.	162.10
FC-08	1/2"	42 lbs.	21400 lbs.	184.40

Dealer Schedule: 500 ft. Spool ..... 253  
250 ft. Spool ..... 103  
1 to 249 ft. (No Spool) ..... 151

***Centralized With Central!***

### "Quick Links"

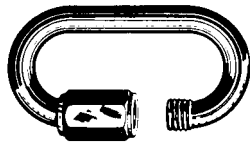

For easy assembly or repair of chain, links open and close in a jiffy. Zinc plated to resist corrosion. No tools required. Also great for repairing tire chains.

Note—Use only with chain of equal or lower working load limit. Quick Links are not heat treated.

No.	Chain Size	Working Load Limit	Ctn. Qty.	Per C
81901	1/8"	220 lbs.	20	\$86.00
81001	3/16"	615 lbs.	20	103.87
81101	1/4"	880 lbs.	20	123.76
81201	5/16"	1540 lbs.	20	203.32
81301	3/8"	1980 lbs.	10	265.20
81501	1/2"	3300 lbs.	10	553.00

Dealer Schedule: Full Ctn. .... 203  
Broken Ctn. .... 102

### Clevis-Pin Type Grab & Slip Hooks



Drop Forged---Heat Treated

ZINC PLATED

#### GRAB HOOKS

No.	Size	Working Load Limit	Each
M804L	1/4" Grab Hook	2600 lbs.	\$5.00
M805L	5/16" Grab Hook	4000 lbs.	6.65
M806L	3/8" Grab Hook	5400 lbs.	8.45
M807L	7/16" Grab Hook	7200 lbs.	13.05
M808L	1/2" Grab Hook	9200 lbs.	17.60
M810L	5/8" Grab Hook	11500 lbs.	51.00
M812L	3/4" Grab Hook	16200 lbs.	57.50

#### SLIP HOOK

M904L	1/4" Slip Hook	2600 lbs.	5.60
M905L	5/16" Slip Hook	4000 lbs.	6.85
M906L	3/8" Slip Hook	5400 lbs.	8.75
M907L	7/16" Slip Hook	7200 lbs.	16.70
M908L	1/2" Slip Hook	9200 lbs.	18.30
M910L	5/8" Slip Hook	11500 lbs.	51.40

Dealer Schedule.....33/133

### Weld-On Grab Hooks

Grade 43 Forged Steel

No.	Size	Each
322-259	5/16"	\$7.90
322-260	3/8"	12.30
322-261	1/2"	18.80

Dealer Schedule.....33/133



### Missing Links



Drop Forged---Heat Treated  
All Sizes Have Rivet Holes Countersunk  
Packed 10 Of A Size Per Package

ZINC PLATED

No.	Size	Dim. Overall	Working Load Limit	Each
82191	1/4	1-1/2 x 1	1400 lbs.	\$5.95
82291	5/16	1-11/16 x 1-5/32	2000 lbs.	6.53
82391	3/8	2-1/16 x 1-3/8	2800 lbs.	6.90
82591	1/2	2-21/32 x 1-23/32	4750 lbs.	10.72

Dealer Schedule: Package Of 10 ..... 33/133  
Broken Box ..... 102

### Forged Mild Steel Cold Shuts



Made from the best grade soft steel and of the standard pattern. Furnished with plain ends.

No.	Description	Working Load Limit	Per C
51190	1/4" Cold Shut	800 lbs.	\$86.70
51290	5/16" Cold Shut	1300 lbs.	99.50
51390	3/8" Cold Shut	1900 lbs.	146.00
51490	7/16" Cold Shut	2100 lbs.	260.00
51590	1/2" Cold Shut	2650 lbs.	285.00

Dealer Schedule: Package Of 10 ..... 33/133  
Broken Package ..... 102



### LAP REPAIR LINKS

No.	Diam.	Lgth.	Working Load Limit	Per C
84090	3/16	1	225 lbs.	\$64.31
84290	1/4	1-1/4	400 lbs.	90.04
84590	5/16	1-1/2	675 lbs.	124.30
84790	3/8	1-5/8	1050 lbs.	195.10
84990	1/2	2-1/2	1525 lbs.	481.00

Dealer Schedule: Pkg. of 10 ea. .... 152  
Broken Pkg. .... 151

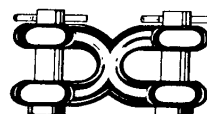

### MID-LINKS

For Repairing Or  
Joining Log Chains

Hot forged, heat treated and tempered with heat treated pins. For use on all Hi-Test and Proof Coil chain.

No.	Chain Size	Each
M605	1/4" or 5/16"	\$7.00
M606	3/8"	8.21
M608	7/16" or 1/2"	16.81
M610	5/8"	27.00

Dealer Schedule.....33/133

## PROOF COIL CHAIN

Zinc Plated

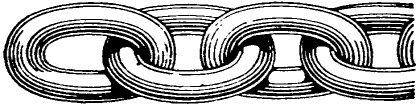

NOT TO BE USED FOR OVERHEAD LIFTING

### Working Load Limit

3/16" .....	800 lbs.	1/4" .....	1300 lbs.
5/16" .....	1900 lbs.	3/8" .....	2650 lbs.

### In Pails (No Broken Pails)

Order No.	Size	Description	Per Pail
2116-403-04 ...	3/16" .....	175' Pail, Wt. 68 lbs. ....	\$213.80
671421 .....	1/4" .....	100' Pail, Wt. 63 lbs. ....	182.50
671422 .....	5/16" .....	70' Pail, Wt. 66 lbs. ....	160.15
671423 .....	3/8" .....	45' Pail, Wt. 63 lbs. ....	145.50

Dealer Schedule.....152

## HIGH TEST CHAIN

Bright Finish - Heat Treated

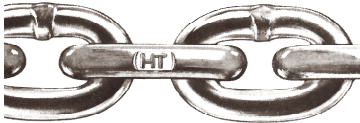

NOT TO BE USED FOR OVERHEAD LIFTING

Trade Size	Wire Diameter	Inside Dimensions Length	Width	Load Limit	Wt./100 Ft.	Ft./Fibre Drum
Inches	Inches	Inches	Inches	Lbs.*	Lbs.*	Drum
1/4 .....	9/32 .....	.82 .....	.39 .....	2600 .....	75 .....	800
5/16 .....	11/32 .....	1.01 .....	.48 .....	3900 .....	111 .....	550
3/8 .....	13/32 .....	1.15 .....	.56 .....	5400 .....	157 .....	400
1/2 .....	17/32 .....	1.50 .....	.81 .....	9200 .....	278 .....	100

No.	Size	Description	Per C/Ft.
HT-04 .....	1/4 in. ....	High Test Chain .....	\$188.76
HT-05 .....	5/16 in. ....	High Test Chain .....	257.30
HT-06 .....	3/8 in. ....	High Test Chain .....	378.62
HT-08 .....	1/2 In. ....	High Test Chain .....	539.70

Dealer Schedule.....203



## Twist Lock Clevis Grab Hook Grade 80 - Zinc Plated

Easy to install, easy to use.  
Most secure latch on the market.  
Prevents inadvertent re-hooking.  
Prevents accidental release of chain from hook connection.

No.	Size	Working Load Limit	Each
G8-200-04 ...	1/4" Twist Lock Hook .....	3500 lbs. ....	\$19.73
G8-200-05 ...	5/16" Twist Lock Hook .....	4500 lbs. ....	23.03
G8-200-06 ...	3/8" Twist Lock Hook .....	7100 lbs. ....	25.93
G8-200-08 ...	1/2" Twist Lock Hook .....	12000 lbs. ....	34.91
G8-200-10 ...	5/8" Twist Lock Hook .....	18100 lbs. ....	53.26

Dealer Schedule.....203

## G-7 Coil Chain



The New G-7 Transport Chain is smaller and lighter than the regular proof coil chain. It is primarily used in the trucking logging and construction industries. Other applications are towing, tiedowns, load binding and farm uses. Especially desirable where a high strength-to weight ratio is required.

G-7 meets Department of Transportation specifications.

NOT TO BE USED FOR OVERHEAD LIFTING

Trade Size	Wire Diameter	Inside Dimensions Length	Width	Load Limit	Wt./100 Ft.	Ft./Fibre Drum
Inches	Inches	Inches	Inches	Lbs.*	Lbs.*	Drum
1/4 .....	9/32 .....	.82 .....	.39 .....	3100 .....	75 .....	400
5/16 .....	11/32 .....	1.01 .....	.48 .....	4700 .....	111 .....	275
3/8 .....	13/32 .....	1.15 .....	.56 .....	6600 .....	157 .....	200
1/2 .....	17/32 .....	1.43 .....	.72 .....	11300 .....	273 .....	100

No.	Size	Description	Per C/Ft.
G7-04 .....	1/4 in. ....	G7 Coil Chain .....	\$385.40
G7-05 .....	5/16 in. ....	G7 Coil Chain .....	391.55
G7-06 .....	3/8 In. ....	G7 Coil Chain .....	500.20
G7-08 .....	1/2 In. ....	G7 Coil Chain .....	1228.00

Dealer Schedule.....203

NOTE---Not Available On Reels



Slip Hook

## G-7 Transport Grade Grab & Slip Hooks

USE WITH G-7 COIL CHAIN  
NOT TO BE USED ON  
OVERHEAD LIFTING



Grab Hook

Order No.	Description	Working Load	Price
M804A .....	Grab Hook 1/4" G7 .....	4350 lbs. ....	\$11.05
M805T .....	Grab Hook 5/16" G7 .....	5375 lbs. ....	8.95
M806T .....	Grab Hook 3/8" G7 .....	6600 lbs. ....	11.70
M808A .....	Grab Hook 1/2" G7 .....	11250 lbs. ....	29.45

3570-025-05 ...	Slip Hook 1/4" G7 .....	3150 lbs. ....	7.15
3570-035-05 ...	Slip Hook 5/16" G7 .....	4500 lbs. ....	9.30
3570-045-05 ...	Slip Hook 3/8" G7 .....	6600 lbs. ....	11.90
3570-065-05 ...	Slip Hook 1/2" G7 .....	11300 lbs. ....	30.90

### Replacement Latch Kits for G7 Slip Hooks

3590-411-05 ...	Latch Kit f/ 1/4" G7 Slip Hook .....	.60
3590-511-05 ...	Latch Kit f/ 5/16" G7 Slip Hook .....	1.02
3590-611-05 ...	Latch Kit f/ 3/8" G7 Slip Hook .....	1.25
3590-711-05 ...	Latch Kit f/ 1/2" G7 Slip Hook .....	1.45

Dealer Schedule.....33/133

NEW PRICES AS OF 1/25/2019

## Log Chains

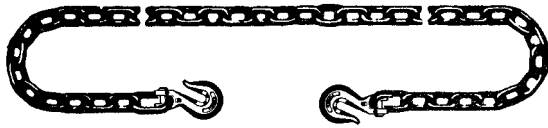

### HEAT TREATED LOG CHAIN

Clevis Grab Hooks Attached---Working Load 5400 lbs.

No.	Description	Price
52334-23	3/8" x 14' Log Chain	\$59.95
52314-23	3/8" x 20' Log Chain	79.95

### G-7 LOG CHAIN

Clevis Grab Hooks Attached---Working Load 6600 lbs.

52620-53	3/8" x 14' G-7 Log Chain	78.50
52621-53	3/8" x 16' G-7 Log Chain	92.91
52623-53	3/8" x 20' G-7 Log Chain	96.31

Dealer Schedule:	3 Or More	152
	Less Than 3	102

Note---Chains May Be Assorted For Quantity Discount.

## Swivel Load Binders

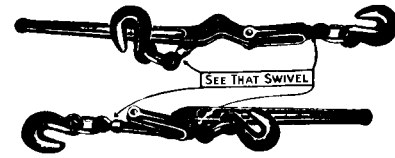

(For Proof Coil & High Test Chain)

Free turning 360° swivels on both hooks for easier handling and better utility. Front tongue for greater take-up. Special handle angle prevents finger trap. Drop forged, short reach hooks for maximum take-up. Solid slot prevents handle spreading. Tie down hole in handle can be locked and/or tied down for security and safety. Locks on ears prevent clevis from spreading.

No.	Description	Chain Size	Price
48314	For P.C. & H.T. Chain	3/16" or 1/4"	\$40.82
48315	For P.C. & H.T. Chain	5/16" or 3/8"	65.00
48316	For Proof Coil Chain Only	1/2"	81.52

Dealer Schedule.....203

## Central CHAIN TIGHTENER



A small compact tool, 11-1/2" long, weighs less than two pounds, but with a leverage of over 700 pounds and a stress load of 2000 lbs.

No.	Description	Price
CT2000	Central Tightener	\$17.60

Dealer Schedule.....152

## G-7 Load Binders



ALLOY HOOKS - USE WITH G-7 COIL CHAIN

Unique design requires a smaller slot in handle for more rigidity and ultimate strength.

Handle closes down away from the load for more leverage in binding and releasing without extra tools.

Handles are special bar quality heat-treated steel.

No.	Description	Working Load	Price
48311	For 5/16" G7 & 3/8" HT Chain	5400	\$66.76
48306	For 3/8" G7 & 1/2" HT Chain	9200	101.41

Dealer Schedule.....203

## Ratchet Load Binders

ALLOY HOOKS  
USE WITH G-7 COIL CHAIN



Order No.	Description	Working Load	Price
8592-236-14	5/16" G7 & 3/8" HT Chain	5400#	\$76.70
8592-238-14	3/8" G7 & 1/2" HT Chain	9200#	87.90

Dealer Schedule.....203

**Fax Toll-Free  
1-800-342-7252**

## Chain Repair Tool

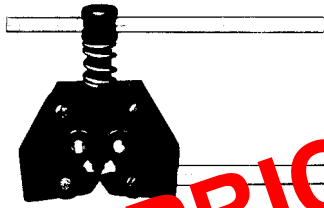

Does the work of a hammer and punch in less than half the time. Does not damage side plates of the chain.

**NEW PRICES AS OF 4/9/2021**

No.	Description	Price
PE-113	#1 Roller Chain Tool (25 to 100 Chain)	\$26.77
PE-135	#2 Roller Chain Tool (100 to 120 Chain)	47.44
PE-160	#3 Roller Chain Tool (120 to 160 Chain)	187.62

### Replacement Parts

PE-113-103	Replacement Screw with Handle & Tip for No. 1 Chain Tool	7.98
PE-135-103	Replacement Screw with Tip, Less Handle for No. 2 Chain Tool	14.22
PE-113-108	Tip for No. 1 Chain Tool	2.27
PE-135-108	Tip for No. 2 Chain Tool	2.63
PE-160-108	Tip for No. 3 Chain Tool	5.74
PE-135-110	Handle Only for No. 2 Tool	3.50
Dealer Schedule: 1 to 2 Tools		152
3 Or More Tools		203
Replacement Parts		152

## KAN-AM Hyd. Roller Chain Breaker Parts

No.	Description	Net
<b>Pins For CB-4 Chain Breaker</b>		
CB-01-103	1/8"x2-3/4" Pin for 35, 40, 41, 2040	\$7.54
CB-01-104	3/16"x2-7/8" Pin for 50, 2050	7.77
CB-01-108	1/4"x2-3/4" Pin for 80, 2080	9.30
CB-01-109	1/4"x2-7/8" Pin for 80, 2080	9.30
CB-01-111	5/16"x2-7/8" Pin for 100	10.23

### Parts Only For Older KAN-AM Chain Breakers

<b>Pins For CB-1 &amp; CB-3 Chain Breaker (Long Style)</b>		
CB-01-017	Pin, 1/8" for 35, 40, 41, 2040	\$6.80
CB-01-023	Pin, 5/16" for 100	10.23
<b>Pins For CB-3 Chain Breaker (Short Style)</b>		
CB-01-016	Pin, 1/8" for 35, 40, 41, 2040	6.80
CB-01-020	Pin, 1/4" for 80, 2080	9.30
CB-01-022	Pin, 5/16" for 100	10.23

## S/V Chain Detacher

### For Standard Riveted Roller Chain

Model A-8050  
Chain-A-Part  
Fits 50, 60, and 80 Series Roller Chain including Heavy-duty 60H and 80H

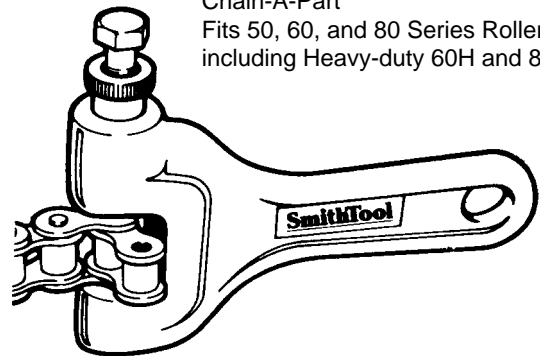

A compact heavy duty tool with ductile body. Long hardened steel punch pushes the pin all the way out while the clamping sleeve assures perfect alignment. Makes repairs quickly to roller chain on farm machinery and industrial equipment without damaging adjacent links.

No.	Description	List
A-8050	Fits 50, 60, 80, 60H, 80H Chain	\$82.60
B-5035	Fits 35, 40, 41, 50 Chain	72.28

### PARTS FOR A -8050

A-8053	Punch	11.36
A-8054	Sleeve	11.45
A-8008	Screw	11.00

### PARTS FOR B-5035

B-5038	Punch	12.08
B-5039	Sleeve	8.70
A-4053	Screw	8.67

Dealer Schedule: Tools		203
Parts		152

## ROLLER CHAIN HOLDER

### For 35 Thru 60 Chain

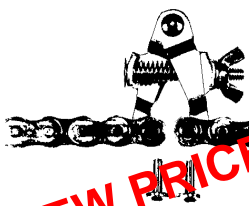

Allows chain to be pulled or released without dropping in the dirt or readjusting sprockets when removing or inserting master links.

For a broken chain, first remove broken link plate with a roller chain breaker. Hold the chain in position with holder. Pry out the broken link and insert new master or replacement link.

No.	Description	Price
CH-1	Roller Chain Holder	\$10.90

Dealer Schedule.....152

**Call: 1-800-444-8666**

**NEW PRICES AS OF 4/9/2021**

**NEW PRICES AS OF 4/9/2021**



**USA CHAIN**

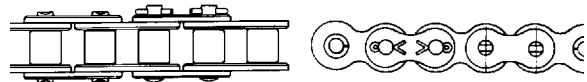

**SINGLE STRAND ROLLER CHAIN**

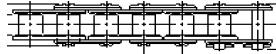

Chain No.	Pitch	Roller Width	Weight Per Ft. Lbs.	Chain Price Per Ft.	Connecting Links Each	Roller Links Each	Offset Links Each	Spring Clips Per C	Bolt & Cotter f/Offset Links Per C	Cotter Keys Per C	Cotter Hook Each
035	3/8"	3/16"	.23	\$8.22	\$1.73	\$.86	\$3.00	\$56.00	\$ N.A.	\$ N.A.	\$ N.A.
041	1/2"	1/4"	.20	7.58	1.71	.96	5.46	34.00	221.00	N.A.	N.A.
040	1/2"	5/16"	.43	6.53	1.77	1.09	4.01	40.00	N.A.	12.00	N.A.
050	5/8"	3/8"	.72	8.10	2.04	1.21	3.79	56.00	N.A.	12.00	N.A.
060	3/4"	1/2"	1.00	10.18	2.36	1.60	4.78	67.00	372.00	12.00	N.A.
080	1"	5/8"	1.68	20.17	**4.75	4.99	10.98	72.00	N.A.	N.A.	2.39
100	1-1/4"	3/4"	2.62	35.60	7.45	9.84	16.98	N.A.	475.00	N.A.	2.52
120	1-1/2"	1"	3.75	49.85	8.98	14.39	25.37	N.A.	N.A.	N.A.	2.54
140*	1-3/4"	1"	5.00	68.52	13.34	20.22	28.08	N.A.	N.A.	N.A.	2.60
160	2"	1-1/4"	6.55	83.90	18.90	27.42	36.05	N.A.	N.A.	N.A.	2.95

\*NOTE—#140 Chain has 10 ft. 2-1/2 inches in a roll.

**HEAVY SINGLE STRAND ROLLER CHAIN**

060H	3/4"	1/2"	1.14	13.76	4.60	2.36	6.51	N.A.	665.00	N.A.	N.A.
080H	1"	5/8"	1.93	28.04	6.68	7.60	14.28	N.A.	N.A.	N.A.	N.A.
100H	1-1/4"	3/4"	3.06	44.25	9.07	16.49	20.11	N.A.	695.00	N.A.	N.A.
120H	1-1/2"	1"	4.30	56.97	12.46	N.A.	27.32	N.A.	N.A.	N.A.	N.A.
140H	1-3/4"	1"	5.54	88.19	18.23	N.A.	40.06	N.A.	N.A.	N.A.	N.A.

**DOUBLE STRAND ROLLER CHAIN**



040-2	1/2"	5/16"	.84	20.33	3.09	N.A.	8.37	N.A.	N.A.	N.A.	N.A.
050-2	5/8"	3/8"	1.40	22.74	3.50	N.A.	9.97	N.A.	N.A.	N.A.	N.A.
060-2	3/4"	1/2"	1.96	33.29	5.13	N.A.	11.13	N.A.	450.00	N.A.	N.A.
060H-2	3/4"	1/2"	2.50	45.28	8.06	N.A.	16.89	N.A.	N.A.	N.A.	N.A.
080-2	1"	5/8"	3.25	61.29	8.50	N.A.	23.90	N.A.	N.A.	N.A.	N.A.
100-2	1-1/4"	3/4"	5.10	97.85	13.38	N.A.	36.65	N.A.	N.A.	N.A.	N.A.

**EXTENDED PITCH ROLLER CHAIN**

**Figure 8 Side Plates**

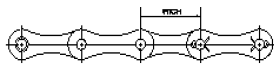

A2040	1"	5/16"	.30	8.81	2.04	1.05	3.77	53.00			
A2050	1-1/4"	3/8"	.45	6.51	2.96	1.36	4.40	53.00			
A2060	1-1/2"	1/2"	.68	14.68	3.09	4.65	5.74	98.00			

**Straight Side Plates**

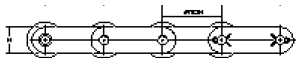

C2040	1"	5/16"	.38	11.30	**2.39	1.08	6.79				
C2050	1-1/4"	3/8"	.59	16.60	**2.78	1.46	4.78				
C2060H	1-1/2"	1/2"	1.05	16.74	**5.94	N.A.	5.79				

\*\*Specify Spring Clip or Cotter Pin Connecting Links

- Order Numbers •••••
- RCA-(Chain No)-(Suffix) •
- Examples: •
- RCA-060-010 = #60 in 10' Roll •
- RCA-060-C = #60 Conn. Link •
- RCA-100-2-O = #100-2 Off. Link •
- 

Dealer Schedule.....152

**DRIVES USA Chain**

**Available in the Following Lengths**

Chain	10' Roll	50' Roll	100' Roll	Chain	10' Roll	50' Roll	100' Roll	Chain	10' Roll	50' Roll	100' Roll	Chain	10' Roll	50' Roll	100' Roll
35	X	X	N.A.	120	X	N.A.	N.A.	140H	X	N.A.	N.A.	A2040	X	X	X
41	X	X	X	140	10' 2-1/2"	N.A.	N.A.	40-2	X	X	X	A2050	X	X	X
40	X	X	X	160	X	N.A.	N.A.	50-2	X	X	N.A.	A2060	X	X	N.A.
50	X	X	X	60H	X	X	X	60-2	X	X	N.A.	C2040	X	X	N.A.
60	X	X	X	80H	X	X	N.A.	60H-2	X	X	N.A.	C2050	X	N.A.	N.A.
80	X	X	N.A.	100H	X	X	N.A.	80-2	X	N.A.	N.A.	C2060H	X	N.A.	N.A.
100	X	X	N.A.	120H	X	X	N.A.	100-2	X	N.A.	N.A.				



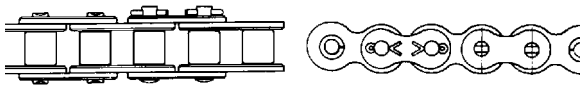

# IMPORTED ROLLER CHAIN

MEETS ANSI STANDARDS

## SINGLE STRAND ROLLER CHAIN

Chain No.	Pitch	Roller Width	Weight Per Ft. Lbs.	Chain Price Per Ft.	Conn. Links Each	Offset Links Each
035	3/8"	3/16"	.22	\$3.15	\$.65	\$1.20
043 (65)	1/2"	1/8"	.20	1.33	.61	1.44
041	1/2"	1/4"	.28	2.69	.86	1.64
040	1/2"	5/16"	.41	3.19	.86	1.64
050	5/8"	3/8"	.68	4.94	1.05	2.06
060	3/4"	1/2"	.96	5.82	1.20	2.58
080	1"	5/8"	1.70	11.53	2.58	5.21
100	1-1/4"	3/4"	2.70	19.49	4.98	10.10
120	1-1/2"	1"	4.00	28.09	5.46	10.97
140	1-3/4"	1"	4.90	32.55	7.72	15.65
160	2"	1-1/4"	6.85	33.29	12.02	24.15
180	2-1/4"	1.40"	9.10	57.27		

NOTE—#140 Chain has 10 ft. 2-1/2 inches in a roll.

## HEAVY ROLLER CHAIN

050H	5/8"	3/8"	.77	6.85	2.06	3.15
060H	3/4"	1/2"	1.14	8.33	2.76	3.32
080H	1"	5/8"	1.93	15.81	3.28	6.45
100H	1-1/4"	3/4"	3.06	24.51	6.36	15.86

## DOUBLE STRAND ROLLER CHAIN

040-2	1/2"	5/16"	.82	7.35	1.64	3.13
050-2	5/8"	3/8"	1.38	10.82	2.06	4.14
060-2	3/4"	1/2"	1.86	12.43	2.58	5.21
080-2	1"	5/8"	3.30	25.31	5.21	10.44
100-2	1-1/4"	3/4"	5.20	39.27	10.10	20.27

## EXTENDED PITCH ROLLER CHAIN

### Figure 8 Side Plates

A2040	1"	5/16"	.30	3.02	1.13	2.33
A2050	1-1/4"	3/8"	.45	4.01	1.64	3.13
A2060	1-1/2"	1/2"	.68	4.96	1.87	3.68

### Straight Side Plates

C2040	1"	5/16"	.38	2.29	.87	1.71
C2050	1-1/4"	3/8"	.59	3.89	1.39	2.34
C2060H	1-1/2"	1/2"	1.05	4.71	1.79	4.05
C2062H	1-1/2"	1/2"	1.42	8.09	1.79	4.05
C2080H	2"	5/8"	1.56	8.30	4.50	8.89
C2082H	2"	5/8"	2.31	14.02	4.50	10.50

## STAINLESS STEEL ROLLER CHAIN (10' rolls only)

SS-040	1/2"	5/16"	.42	11.32	1.37	2.59
SS-050	5/8"	3/8"	.70	18.08	2.10	3.57
SS-060	3/4"	1/2"	1.01	26.51	2.89	4.89
SS-A2050	1-1/4"	3/8"	.47	16.85	4.10	5.93

Dealer Schedule: 10' to 99'.....152 100' or More.....152 & 150

Links & Parts.....152

- 
- Order Numbers = IRC-(Chain No)-(Suffix) •
- Examples: IRC-043-100 = #43 in 100' Roll •
- IRC-C2080H-C = #C2080H Conn. Link •
- IRCSS-060-O = #60 S.S. Offset Link •
- 

## Steel Chain Detacher

For separating all sizes of Detachable Steel Chain and steel attachment links.

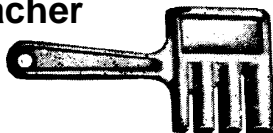

No.	Description	Each
CD-415	Steel Chain Detacher	\$24.50
Dealer Schedule.....		203

Imported Roller Chain							
Available In The Following Lengths							
Chain	10'	50'	100'	Chain	10'	50'	100'
35	X	N.A.	X	40-2	X	N.A.	N.A.
43 (65)	X	N.A.	X	50-2	X	X	N.A.
41	X	N.A.	X	60-2	X	X	N.A.
40	X	N.A.	X	80-2	X	N.A.	N.A.
50	X	X	X	100-2	X	N.A.	N.A.
60	X	X	N.A.	A2040	X	X	X
80	X	X	N.A.	A2050	X	N.A.	X
100	X	X	N.A.	A2060	X	N.A.	N.A.
120	X	N.A.	N.A.	C2040	X	N.A.	N.A.
140	10' 2-1/2"	N.A.	N.A.	C2050	X	N.A.	N.A.
160	N.A.	N.A.	N.A.	C2060H	X	N.A.	N.A.
50H	N.A.	N.A.	N.A.	C2062H	X	N.A.	N.A.
60H	X	X	N.A.	C2080H	X	N.A.	N.A.
80H	X	X	N.A.	C2082H	X	N.A.	N.A.
100H	X	N.A.	N.A.	Stainless Steel in 10' rolls only!			



## Sprayon Open Chain Lubricant

Excellent for chain drive equipment. Penetrates, protects and provides a cleansing action. Moly additive enables moisture displacement. May be used as a protective coating for metal parts while in storage. Withstands extreme temperatures. Increases chain life up to 3 times longer when applied on a regular basis. 12 Per Case.

No.	Each
00202	Open Chain Lubricant, 12 oz. .... \$9.90

## Sprayon Dry Moly Chain Lube

Dry Moly Lube is a high solids, molybdenum disulfide coating that withstands high pressures. This product bonds to all clean surfaces that are not adversely affected by alcohol or aromatic hydrocarbons, such as toluene or xylene.



NSF reg. no. 131583; H2 rated - Penetrates pores of substrate and bonds to surface for long-lasting lubrication - High-pressure, high-solids molybdenum disulfide coating - Withstands pressures up to 50,000 psi - Air dries in 5-10 minutes; cures in 2 hours at room temperature - Maintains effectiveness under high temperatures (650°F constant and 750°F intermittent) - Non-conductive - Equipped with EZ TOUCH® Standard Nozzle - Coefficient of friction is .23 per ASTM D4518 - Works as a boundary lube as cold as -200°F

**Recommended Uses:** Assembly and run-in lubrication, automotive and industrial parts, sliding surfaces and gears, chutes and bins, bearings, chain drives, intricate mechanisms, vending machines, parking meters, roller chains and conveyor belts where heat is present.

No.	Description	Each
00200	Dry Moly Chain Lube, 10 oz. ....	\$12.10
Dealer Schedule: Full Case of 12 .....		253
Broken Case .....		102

**DETACHABLE STEEL CHAIN**

Sold In 10' Rolls Only

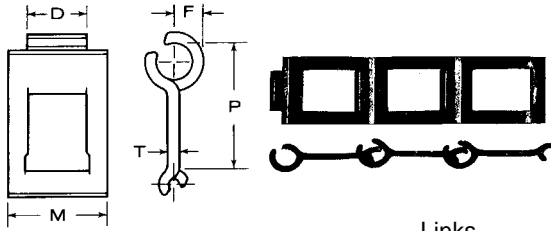

No.	Chain	M	P	T	Links In 10'	Per Ft.
DC-25	25	45/64	.904	.073	133	\$4.35
DC-32	32	15/16	1.157	.090	104	4.78
DC-32W	32W	1-1/16	1.157	.095	104	4.88
DC-33*	33	1-15/16"	1.402	.095	86	4.66
DC-42	42	1-7/32	1.375	.105	87	4.87
DC-50H	50H	1-9/32	1.375	.125	87	5.77
DC-51	51	1-3/32	1.133	.100	106	5.83
DC-52	52	1-13/32	1.508	.120	80	5.30
DC-55	55	1-9/32	1.630	.125	74	5.18
DC-62	62	1-9/16	1.654	.148	73	7.28
DC-62A	62A	1-15/16	1.664	.170	72	13.10
DC-62H	62H	1-7/8	1.654	.155	73	8.92
DC-67H	67H	1-7/8	2.313	.185	52	9.89
DC-67XH	67XH	1-7/8	2.313	.200	52	12.61
DC-72	72	1-15/16	2.025	.170	59	11.46
DC-S	S	1-15/16	2.906	.170	41	10.80

\*WILL NOT replace 33/34 Endgate Seeder Chain  
Dealer Schedule.....152

**IMPLEMENT ROLLER CHAIN**

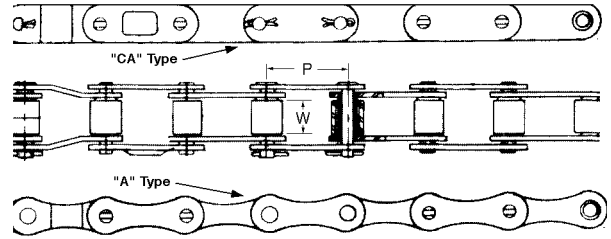

Replacement for No. 55 and No. 62 Detachable Steel Chain.

**Roller Drive Chain—Relieved Side Bars.**

Order No.	Size	P	W	Wt. Per Roll	Per Ft.
RC-A550	A550	1.630	.797	11#	\$18.36
RC-A620	A620	1.654	.984	13.8#	22.25

**Roller Conveyor Chain—Straight Side Bars.**

RC-CA550	CA550	1.630	.797	13#	18.36
RC-CA551X	CA551X	1.630	.797	24.3#	42.80
RC-CA555	CA555	1.630	.500	10.3#	18.36
RC-CA557	CA557	1.630	.797	17.3#	19.01
RC-CA620	CA620	1.654	.984	15.7#	22.25

Above Sold In 10' Rolls Only.

Order No.	Description	Each
RC-A550-C	A550 Connecting Link	\$4.40
RC-A620-C	A620 Connecting Link	5.05
RC-CA550-C	CA550 C/P Connecting Link	4.40
RC-CA550-C-SC	CA550 S/C Connecting Link	4.40
RC-CA551X-C	CA551X C/P Connection Link	7.86
RC-CA555-C	CA555 Connecting Link	4.40
RC-CA557-C	CA557 C/P Connecting Link	5.92
RC-CA620-C	CA620 Connecting Link	5.05
RC-A550-R	A550 Roller Link	4.81
RC-A620-R	A620 Roller Link	5.15
RC-CA550-R	CA550 Roller Link	5.15
RC-CA555-R	CA555 Roller Link	4.22
RC-CA620-R	CA620 Roller Link	5.15
RC-A550-O	A550 Offset Link	4.81
RC-A620-O	A620 Offset Link	7.75
RC-CA550-O	CA550 Offset Link	4.81
RC-CA551X-O	CA551X Offset Link	8.20
RC-CA555-O	CA555 Offset Link	5.37
RC-CA557-O	CA557 Offset Link	6.00
RC-CA620-O	CA620 Offset Link	7.75

Order No.	Description	Each
RC-A550-PC	Pin & Cotter for 550 Offset Links	\$2.75
RC-CA555-PC	Pin & Cotter for CA555 Offset Links	2.75
RC-A620-PC	Pin & Cotter for 620 Offset Links	2.85

Dealer Schedule.....152

**STEEL ATTACHMENT LINKS**



Sold Individually

Order No.	Each	Order No.	Each
DCL-55-A1R	\$1.41	DCL-62-C1	\$2.41
DCL-55-A1L	1.41	DCL-62-G27R	2.90
DCL-55-C1	1.97	DCL-62-G27L	2.90
DCL-55-G27R	2.00	DCL-62-HB4	4.50
DCL-55-G27L	2.00	DCL-62-K1	3.00
DCL-55-HB4	2.90	DCL-62-SD	3.00
DCL-55-K1	2.90	DCL-62 Coupler	9.75
DCL-55-SD	2.16	DCL-67H-ASR	3.86
DCL-55 Coupler	8.50	DCL-67H-ASL	3.86
DCL-62-A1R	2.20	DCL-67XH-ASR	4.60
DCL-62-A1L	2.20	DCL-67XH-ASL	4.60
DCL-62-A2R	3.70	DCL-SBR	4.70
DCL-62-A2L	3.70	DCL-SBL	4.70

Dealer Schedule.....152

**FLATHEAD RIVETS FOR ATTACHMENT LINKS**  
(Sold Only In Packages Of 50 Each)

Order No.	Size	Chain Series	Per C
RVF-0250-0500	1/4" x 1/2"	55, 62, 662	\$22.79
RVF-0312-0750	5/16" x 3/4"	67H, 67XH, 667H, 667X	39.40

Dealer Schedule.....152

NEW PRICES AS OF 1/23/2020

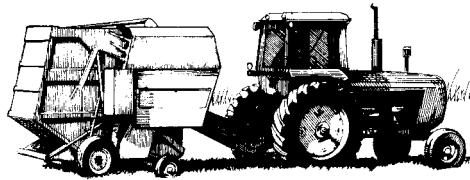

## NEW HOLLAND ROUND BALER CHAINS

### FLOOR CHAINS

Order Number	Reference Number	New Holland Number	Description	Wt.	Price Each
C5881	NH846/7F	714619	CA550-61-C5E-15	21	\$182.80
C4220	NH845/46/47RS	Repair Section	CA550-3-C5E-1	.08	9.90
C4221	NH851/2F	Repair Section	CA550-3-C5EB-1	1	10.95

All floor chains are individually boxed and labeled. Hot dip lubrication. Chains include one cottered connector link for assembly.  
 Note—C5EB indicates wear bar.

### UPPER CHAIN REPAIR SECTIONS

Order Number	Reference Number	New Holland Number	Description	Wt.	Price Each
E4101	NH851/52RS	639219	CA557-3-U16-1	1.3	\$30.70

NOTE---Bolts NOT Furnished Outside Hole Use 5/16" x 1-1/2" Grade 5 Center Holes Use 3/8" x 1-1/2" Grade 5



### FEED WAGON LIFT CHAINS

For Blair Mfg. (Kelly-Ryan) Wagons.

9' 8" Long Chains, Attachments every 6th link spaced 9-5/8" C to C

**Sold In Pairs Only**

#C4126  
Shown

No.	Description	Wt.	Per Pair
C5729	Each chain consists of 71-CA550 and 12-G50A links	30	\$518.40

### 3-LINK ATTACHMENT REPLACEMENTS

No.	Description	Each
C4127	Consists of 3-CA550 and 1-G50AL links	\$16.35
C4126	Consists of 3-CA550 and 1-G50AR links	16.35

No.	Description	Chain Type	Each
KR551XG50R	Attachment Link RH	CA551X-G50 RH	\$13.00
KR551XG50L	Attachment Link LH	CA551X-G50 LH	13.00

### QUICK-TACH CHAIN LINKS

Chain No.	Pitch	D Inside Width	W Outside Width	T Thickness	Approx. Links in 10'	Wt. Per C	Ave. Ultimate Strength	Max. Working Load
AL67-T	2.550"	1.125"	2.000"	0.312"	47	42 lbs.	16,000 lbs.	2,285 lbs.
AL88-T	2.773"	1.093"	2.000"	0.312"	43	53 lbs.	16,000 lbs.	2,285 lbs.
AL67-T-ROD	2.388"	1.125"	2.500"	0.437"	50	40 lbs.	16,000 lbs.	2,285 lbs.

No.	Desc.	Per Link
AL67-T	T Bar Link	\$3.25
AL88-T	T Bar Link	5.10
AL67-T-ROD	T Rod Link	3.10

DEALER SCHEDULE THIS PAGE.....152

ALL PRICES SUBJECT TO CHANGE WITHOUT NOTICE.

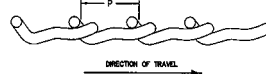
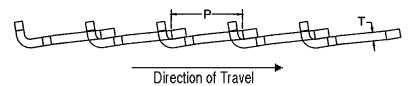

**Call Toll Free: 1-800-444-8666**

#67H & 67XH

**SPREADER CONVEYOR CHAIN ASSEMBLIES**

#662, 667H & 667X

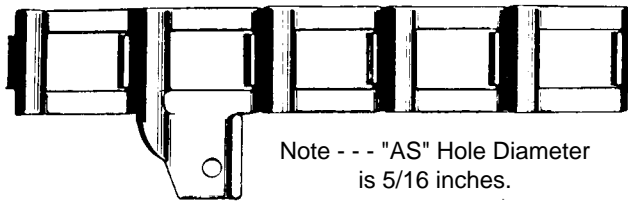

Note - - - "AS" Hole Diameter is 5/16 inches.

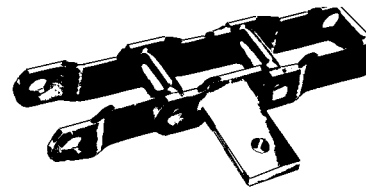

Available in No. 67H & 67XH steel detachable chain and in No. 662, 667H & 667X steel pintle chain.  
Save - Using original slats and replacing worn out chain only.

**FULL ASSEMBLY:** Full assembly consists of a matched pair of 20 foot chains with attachment spaced every seventh pitch.  
 #CC-1000 consists of 126 plain links and 21 "AS" attachment links per chain. All other numbers consist of 90 plain links, 15 "AS" attachment links per chain.  
**ADD ON SECTION:** Add on sections and loose links allow assembly to be altered to exact O.E.M. length.  
 #CC-2000 consists of a pair of 1' sections with 6 plain links and 1 "AS" attachment. All other other numbers consists of a pair of 1'3" sections consisting with 6 plain links and 1 "AS" attachment.

**LOOSE LINKS & PINS**

(For Pintle Chain Links See Next Section Below)

**ASSEMBLIES**  
**Sold In Matched Pairs Only**

Order No.	Description	Wt.	Per Pair
CC-1000	662 Spreader Chain Ass'y	47.0	\$686.80
CC-1001	67H Spreader Chain Ass'y	58.8	488.34
CC-1002	67XH Spreader Chain Ass'y	63.2	570.00
CC-1003	667H Spreader Chain Ass'y	55.0	619.10
CC-1004	667X Spreader Chain Ass'y	85.0	843.40
CC-2000	662 Add On Section	1.8	32.70
CC-2001	67H Add On Section	3.8	34.80
CC-2002	67XH Add On Section	4.2	36.90
CC-2003	667H Add On Section	3.4	36.70
CC-2004	667X Add On Section	4.4	53.00

Dealer Schedule.....152

Order No.	Description	Each
DCL-67H-ASL	Left Attachment Link	\$3.86
DCL-67H-ASR	Right Attachment Link	3.86
DCL-67XH-ASL	Left Attachment Link	4.60
DCL-67XH-ASR	Right Attachment Link	4.60
AL662-PC	Pin and Cotter (Serrated)	3.10
AL662-PC-TD	Tear Drop Pin & Cotter	3.10
AL667H-PC	Pin and Cotter (Serrated)	4.20
AL667H-PC-TD	Tear Drop Pin & Cotter	4.20
AL667X-PC	Pin and Cotter (Serrated)	5.06
AL667X-PC-TD	Tear Drop Pin & Cotter	5.06
AL667K-PC	Pin and Cotter (Serrated)	5.00
AL667K-PC-TD	Tear Drop Pin & Cotter	5.00
AL667XH-PC	Pin and Cotter (Serrated)	5.16
AL667XH-PC-TD	Tear Drop Pin & Cotter	5.16
AL88XH-PC	Pin and Cotter (Serrated)	5.67
AL88XH-PC-TD	Tear Drop Pin & Cotter	5.67

**STEEL PINTLE CHAIN**

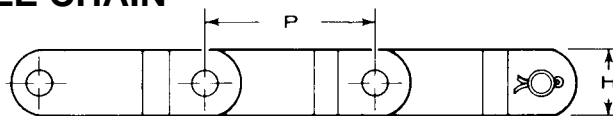
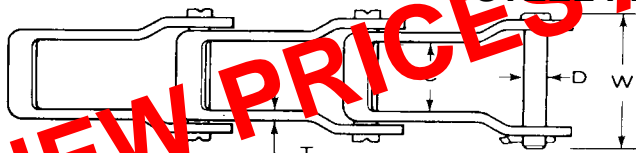

**PINTLE CHAIN SPECIFICATIONS TABLE**

Chain No.	P Pitch	D Pin Dia.	Overall Width	C Inside Width	H Height	T Thickness	Approx. Lks. Per 10 ft.	Min. Ave. Strength
AL662	1.664"	.281"	1-5/8"	29/32"	.720"	.125"	72	8,500 lbs.
AL667H	2.313"	.312"	1-47/64"	1"	.875"	.125"	52	9,500 lbs.
AL667X	2.250"	.437"	1.61/64"	1-1/16"	.937"	.170"	53	15,000 lbs.
AL667K	2.250"	.437"	2.1/8"	1.078"	1.062"	.200"	53	20,000 lbs.
AL667XH	2.250"	.469"	2-5/16"	1-5/64"	1.062"	.224"	53	26,000 lbs.
AL88XH	2.609"	.500"	2-41/64"	1-1/4"	1.125"	.250"	46	30,000 lbs.

This chain has open barrel construction elimination freeze-ups and pin heads are coined on four sides (tent staked) reducing possible pin rotation.  
 AL667H is interchangeable with #667 type manufactured by others. AL667X is the same as AL667H but is of heavier construction throughout and is adaptable to much heavier loads. AL662 is interchangeable with #662 type chains manufactured by others and can also be used to replace #62 Steel Detachable Chain without replacing sprockets.

No.	Description	Per 10 Ft.
AL662	Pintle Chain	\$120.15
AL667H	Pintle Chain	116.75
AL667X	Pintle Chain	170.55
AL667K	Pintle Chain	257.35
AL667XH	Pintle Chain	272.35
AL88XH	Pintle Chain	335.28

**Note** ..... **Sold Only in 10 ft. Rolls.**

DEALER SCHEDULE.....152

No.	Description	Per Link
AL662-CO	Plain Coupler Link	\$6.05
AL667H-CO	Plain Coupler Link	7.22
AL667X-CO	Plain Coupler Link	8.40
AL667K-CO	Plain Coupler Link	14.05
AL667XH-CO	Plain Coupler Link	15.60
AL88XH-CO	Plain Coupler Link	18.70
AL662-AS-CO	Coupler Link w/Bar	6.40
AL667H-AS-CO	Coupler Link w/Bar	8.98
AL667X-AS-CO	Coupler Link w/Bar	17.58
AL667K-AS-CO	Coupler Link w/Bar	19.20
AL667XH-AS-CO	Coupler Link w/Bar	18.24
AL88XH-AS-CO	Coupler Link w/Bar	21.00

Note: Serrated head pins & cotters included.

**ALL PRICES SUBJECT TO CHANGE WITHOUT NOTICE.**

## HUB CITY PTO ADAPTERS

Standard Duty Up To 75 H.P.

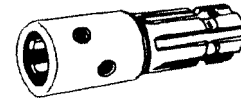

Order No.	Female Spline	Male Spline	Length	Extends PTO	Secured By	Price
03-32-03531	1-1/8-6	1-3/8-6	5-1/2	3-9/16	Cross Pin	\$34.50
03-32-00377	1-1/8-6	1-1/8-6	5-3/8	4-1/16	Cross Pin	61.05
03-32-00420	1-3/8-6	1-1/8-6	5-1/8	2-13/16	Cross Pin	59.45
03-32-00371	1-3/8-6	1-3/8-6	6-1/2	4-9/16	Cross Pin	66.10
03-32-00378	1-3/8-6	1-3/8-6	5-1/8	2-15/16	Cross Pin	64.10
03-32-00373	1-3/8-21	1-3/8-6	6-1/2	4-1/2	Set Screw	62.80
03-32-00401	1-3/4-6	1-3/8-6	6-1/2	4-3/4	Cross Pin	107.05

## HEAVY DUTY PTO ADAPTERS

Designed For High Horsepower Tractors Up To 125 H.P.

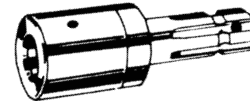

Order No.	Female Spline	Male Spline	Length	Extends PTO	Secured By	Price
03-32-00001	1-3/8-21	1-3/8-21	6-7/8	4-13/16	Set Screw	\$239.90
03-32-00002	1-3/8-21	1-3/8-6	6-7/8	4-13/16	Set Screw	239.90
03-32-00004	1-3/8-6	1-3/8-21	6-7/8	4-13/16	Set Screw	239.90

## PTO ADAPTERS

For Tractors with 1-3/4-20 Spline PTO Up To 75 H.P.

03-32-00070



Order No.	Female Spline	Male Spline	Length	Extends PTO	Price
03-32-00070	1-3/8-21	1-3/4-20	7-3/16	4-15/16	\$186.40
8-47-12-44-038	1/2 x 1 SAE Socket Set Screw				2.55
8-47-16-14-001	1/2 SAE Self Locking Nut				1.60

NEW PRICES AS OF 1/28/2020

## CLAMP TYPE PTO ADAPTERS

For Tractors with 1-3/4-20 Spline PTO Up To 75 H.P.

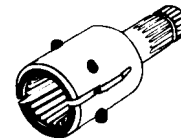

Order No.	Female Spline	Male Spline	Length	Extends PTO	Price
03-32-01476	1-3/4-20	1-3/8-6	7-13/16	4-15/16	\$154.60
03-32-01477	1-3/4-20	1-3/8-21	7-13/16	4-15/16	154.60

## HEAVY-DUTY PTO ADAPTERS

For Tractors with 1-3/4-20 Spline PTO Up To 125 H.P.

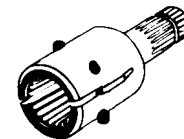

Order No.	Secured By	Female Spline	Male Spline	Length	Extends PTO	Price
03-32-00094	Clamp Type	1-3/8-21	1-3/4-20	7	4-1/2	217.36
03-32-01490	Clamp Type	1-3/4-20	1-3/8-6	8-3/16	4-15/16	215.70
03-32-01491	Clamp Type	1-3/4-20	1-3/8-21	8-3/16	5-7/16	215.70
847-11-44103	Socket Cap Screw for Above PTO Adapters					3.08
847-16-11013	Lock Washer for Above PTO Adapters					.27

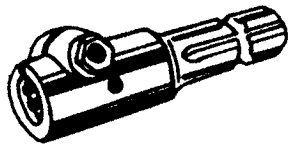

### HUB CITY CLAMP TYPE PTO ADAPTER For Up To 75 HP

Order No.	Female Spline	Male Spline	Length	Extends PTO	Price
03-32-01354	1-1/8-6	1-3/8-6	7-5/16	4-5/8	\$185.45
03-32-00087	1-3/8-21	1-3/8-6	7-5/16	4-3/8	183.50

### SLEEVE TYPE SPLINED ADAPTERS For Up To 75 HP



Order No.	Female Spline	Male Spline	Length	Price
03-32-00352	1-1/8-6	1-3/8-6	2-1/4	\$24.36
03-32-00363 (Replaces Ford 231082)	1-1/8-6	1-3/8-6	2	16.60
03-32-00355 (IHC Cub & Kubota)	31/32-10	1-3/8-6	2-1/4	35.55

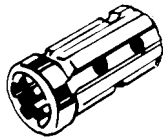

### "FORGED" PTO ADAPTER For Up To 75 HP

Forged internal spline. Universal quick detach slot and bolt holes. Can be used with any American, British, or European PTO system. Furnished with 5/16" x 1-1/16" spring pin for direct connection to PTO. Overall length 5 inches. Extends PTO 1-1/8 inch.

Order No.	Female Spline	Male Spline	Length	Extends PTO	Price
03-32-00018	1-1/8-6	1-3/8-6	3	1-1/8	\$23.60

### KWIK-DETACH OVER-RUNNING COUPLERS Heavy Duty Tractor Models - - - Up To 125 HP Maximum Recommended Operating Speed 1000 RPM



Order No.	Female Spline	Male Spline	Fits Tractors	Price
03-31-00010	1-3/8-6	1-3/8-6	All 1-3/8-6 Spline	\$436.60
03-31-00011	1-3/8-6	1-3/8-21	All 1-3/8-6 Spline	385.00

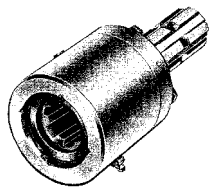

### OVER-RUNNING COUPLERS Standard Duty Tractor Models - - - Up To 75 HP Maximum Recommended Operating Speed 1000 RPM

Order No.	Female Spline	Male Spline	Fits Tractors	Price
03-31-00660	1-3/8-6	1-3/8-6	All w/Cross Pin Hole Including Ford	\$130.60
03-31-00670	1-1/8-6	1-3/8-6	All w/Cross Pin Hole Including Ford	130.60

### OVER-RUNNING COUPLER REPAIR KIT

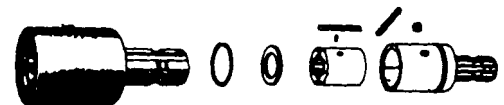

Kit contains all parts except inner sleeve and outer housing. Inner component parts are not sold separately.

Order No.	Price
03-37-00076	Standard Duty, Heavy Duty & Utility ..... \$39.25

DEALER SCHEDULE THIS PAGE.....152

ALL PRICES SUBJECT TO CHANGE WITHOUT NOTICE.

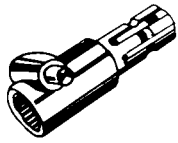

Push Button Type

## KWIK-D-TACH PTO SPLINED ADAPTERS

For Up To 75 HP



Spring Loaded Collar  
Rotates About 30 Degrees

Order No.	Female Spline	Male Spline	Length	Extends PTO	Type	Price
03-32-00010	1-3/8-6	1-3/8-6	6-1/2	4-5/16	Twist Collar	\$108.10
03-32-00013	1-3/8-6	1-3/8-21	6-1/2	4-5/16	Twist Collar	108.10
03-32-00092	1-3/8-6	1-3/8-21	6-1/2	4-5/16	Push Button	60.45
03-32-00015	1-3/8-6	1-1/8-6	6-1/2	4-5/16	Twist Collar	111.90
03-32-01373	1-3/8-21	1-3/8-6	6-1/2	4-5/16	Twist Collar	112.20
03-32-01375	1-3/8-21	1-3/8-6	6-1/2	4-5/16	Push Button	65.95
03-32-02121	1-3/8-21	1-3/8-21	6-1/2	4-5/16	Twist Collar	125.40
03-36-00182	New Style Pin & Spring w/Roll Pin f/#03-32-01375					17.30

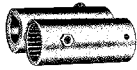

## HUB CITY SPLINED PUMP DRIVE ADAPTERS

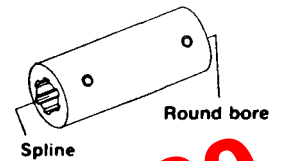

PTO pin included with all 1-3/8 6 spline pump drives. 1-3/8 21 spline pump drives are supplied with set screws.

Order No.	Female Spline	Female Round*	Keyway	Length	Price
03-32-00407	1-3/8-6	.625	3/16 x 3/32	4-11/32	\$76.80
03-32-00408	1-3/8-6	.750	3/16 x 3/32	4-11/32	76.80
03-32-00409	1-3/8-6	.875	3/16 x 3/32	4-11/32	76.80
03-32-00413	1-3/8-6	.937	1/4 x 1/8	4-11/32	100.70
03-32-00410	1-3/8-6	1.000	1/4 x 1/8	4-11/32	76.80
03-32-00411	1-3/8-6	1.125	1/4 x 1/8	4-11/32	78.60
03-32-00612	1-3/8-21	.937	1/4 x 1/8	4-3/8	112.20
03-32-00611	1-3/8-21	1.125	1/4 x 1/8	4-3/8	112.20
03-32-00610	1-3/8-21	1.000	1/4 x 1/8	4-3/8	112.20

\*Nominal +.002"

NEW PRICES AS OF 1/28/2020

## KWIK-D-TACH SPLINED PUMP DRIVE



Order No.	Female Spline	Female Round*	Keyway	Length	Price
03-32-00040	1-3/8-6	.937	1/4 x 1/8	4-13/32	\$109.30
03-32-00016	1-3/8-6	1.000	1/4 x 1/8	4-13/32	109.30
03-32-00017	1-3/8-6	1.125	1/4 x 1/8	4-13/32	109.30

\*Nominal +.002"

## ROUND SHAFT ADAPTERS

For Up To 75 HP

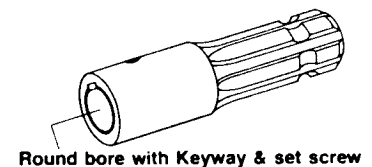

Order No.	Female Round	Keyway	Male Spline	Length	Extends PTO	Price
03-32-00376	1	1/4	1-3/8-6	5-3/4	3-1/4	\$68.30
03-32-00430	1-1/8	1/4	1-3/8-6	5-11/16	3-3/16	78.40
03-32-00431	1-1/4	1/4	1-3/8-6	5-11/16	3-3/16	90.90
03-32-00432	1-3/8	5/16	1-3/8-6	5-11/16	3-3/16	93.40

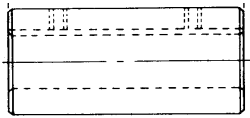

### HUB CITY ROUND BORE COUPLINGS

Order No.	Bore Size	Keyway	O.D.	Length	Price
03-32-00379	1-1/2	3/8	2-1/4	3	\$52.05
03-32-00380	3/4	3/16	1-1/2	2-3/4	27.45
03-32-00381	7/8	3/16	1-1/2	2-3/4	27.45
03-32-00382	1	1/4	1-3/4	2-3/4	27.45
03-32-00384	1-1/8	1/4	2	3	48.30
03-32-00388	1-3/8	5/16	2-1/8	3	51.10

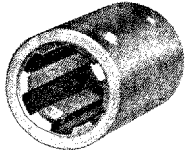

### HUB CITY SPLINED COUPLINGS

Order No.	Spline Size	O.D.	Length	Price
03-32-00341	1-6	1-3/8	2-3/4	\$37.75
03-32-00344	1-1/8-6	1-9/16	2-3/4	35.40
03-32-00345	1-3/8-6	1-3/4	3-3/4	40.41
03-32-00320	1-3/4-20	2-1/4	3-3/4	45.20



### HUB CITY SPLINED COUPLING

Order No.	No. of Splines	Spline O.D.	Cplg. O.D.	Cplg. Lgth.	Price
03-32-00350	21	1.375	1-3/4	3	\$45.20

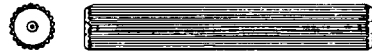

### HUB CITY SPLINED SHAFT

Order No.	No. of Splines	Spline O.D.	Shaft Length	Price
03-32-00395	21	1.375	10	\$107.30



### HUB CITY SPLINED SHAFT

Order No.	Size	Spline	Length	Price
03-32-00394	1-3/8	6	10	\$42.45

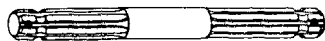

### HUB CITY EXTENSION SHAFT

Order No.	Male Spline	Male Spline	Length	Price
03-32-00356	1-3/8-6	1-3/8-6	9	\$63.80



### HUB CITY SPLINED WELD-ONS

Order No.	Spline	Length	Price
03-32-00359	1-3/8-6	5-1/2	\$36.25
03-32-00019	1-3/8-21	5-1/2	59.80

NEW PRICES AS OF 1/28/2020



**SPLINED ADAPTER SLEEVE**  
ENLARGES PTO 1-1/8 to 1-3/8

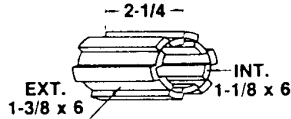

Order No.	Price
11651822 .....	\$24.78

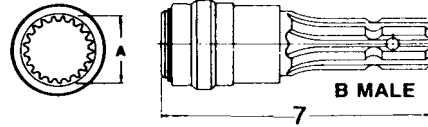

**SNAP HITCH SPLINED ADAPTER**

No.	A Female	B Male	Length	Price
23531 .....	1-3/8 - 21 .....	1-3/8 x 6 .....	7 .....	\$35.15

**PUMP ADAPTER**

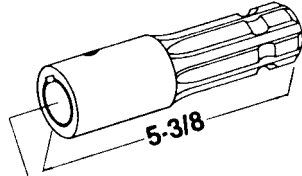

**1-3/8 x 6 Spline Male**  
End to Round Bore

Round bore with Keyway & set screw

Order No.	Spline	Rd. Bore	Keyway	Price
113-1600 .....	1-3/8 - 6 .....	1 .....	1/4 .....	\$51.66
113-1800 .....	1-3/8 - 6 .....	1-1/8 .....	1/4 .....	51.66
113-2000 .....	1-3/8 - 6 .....	1-1/4 .....	1/4 & 5/16 .....	51.66
113-2200 .....	1-3/8 - 6 .....	1-3/8 .....	5/16 .....	58.96
113-2400 .....	1-3/8 - 6 .....	1-1/2 .....	3/8 .....	58.96

All of the above are 5-3/8 in length.

**SPLINED ADAPTER**

Extended Length for use with Gresen Pump

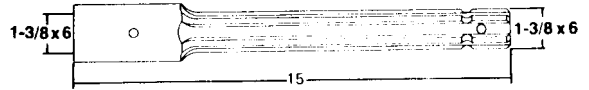

No.	Description	Price
23676 .....	Splined Adapter, 1-3/8"-6, 15" Length .....	\$57.60

**SNAP HITCH PUMP ADAPTER**  
1-3/8 Spline Snap Hitch to Round Bore

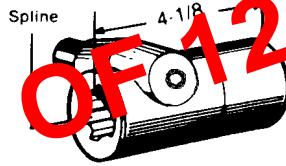

Round Bore with Keyway and Set Screw.

Order No.	Spline	Rd. Bore	Keyway	Price
114-1000 .....	1-3/8 x 6 .....	5/8 .....	3/16 .....	\$66.43
114-1200 .....	1-3/8 x 6 .....	3/4 .....	3/16 .....	66.43
114-1400 .....	1-3/8 x 6 .....	7/8 .....	3/16 & 1/4 .....	71.78
114-1500 .....	1-3/8 x 6 .....	15/16 .....	1/4 .....	66.43
114-1600 .....	1-3/8 x 6 .....	1 .....	1/4 .....	66.43
115-1000 .....	1-3/8 x 21 .....	5/8 .....	3/16 .....	70.94
115-1200 .....	1-3/8 x 21 .....	3/4 .....	3/16 .....	70.94
115-1400 .....	1-3/8 x 21 .....	7/8 .....	3/16 & 1/4 .....	76.38
115-1500 .....	1-3/8 x 21 .....	15/16 .....	1/4 .....	70.94
115-1600 .....	1-3/8 x 21 .....	1 .....	1/4 .....	70.94

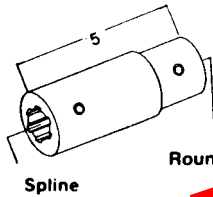

**PUMP COUPLER**

Round bore with keyway & set screw

Order No.	Spline Size	Round Bore	Keyway	Price
10180616 .....	1-1/8 - 6 .....	1 .....	1/4 .....	\$66.75
10220614 .....	1-3/8 - 6 .....	7/8 .....	3/16 .....	66.75
10220615 .....	1-3/8 - 6 .....	15/16 .....	1/4 .....	66.75
10220625 .....	1-3/8 - 6 .....	25mm .....	1/4 .....	66.75
10220616 .....	1-3/8 - 6 .....	1 .....	1/4 .....	66.75
10222116 .....	1-3/8 - 21 .....	1 .....	1/4 .....	66.75
10220618 .....	1-3/8 - 6 .....	1-1/8 .....	1/4 .....	66.75

All or the above are 5 inch in length.

**STANDARD LENGTH SPLINED SHAFTS**

Splined shafts are made from cold rolled steel.



Order No.	Desc.	Splined Size	Length	Price
106A1615 .....	One End .....	1"-15 .....	6 .....	\$39.23
106A1806 .....	One End .....	1-1/8"-6 .....	6 .....	35.33
106A2014 .....	One End .....	1-1/4"-14 .....	6 .....	18.49
106A2206 .....	One End .....	1-3/8"-6 .....	6 .....	31.69
106A2221 .....	One End .....	1-3/8"-21 .....	6 .....	32.49
106A2820 .....	One End .....	1-3/4"-20 .....	6 .....	57.29
112A1615 .....	One End .....	1"-15 .....	12 .....	44.17
112A1806 .....	One End .....	1-1/8"-6 .....	12 .....	49.41
112A2206 .....	One End .....	1-3/8"-6 .....	12 .....	56.35
112A2221 .....	One End .....	1-3/8"-21 .....	12 .....	59.04
112A2820 .....	One End .....	1-3/4"-20 .....	12 .....	72.74

Order No.	Desc.	Splined Size	Length	Price
112B1615 .....	Both Ends ...	1"-15 .....	12 .....	\$52.09
112B2206 .....	Both Ends ...	1-3/8"-6 .....	12 .....	67.97
112B2221 .....	Both Ends ...	1-3/8"-21 .....	12 .....	67.20
112B2820 .....	Both Ends ...	1-3/4"-20 .....	12 .....	88.12
112F1615 .....	Full Length ..	1"-15 .....	12 .....	85.84
112F2206 .....	Full Length ..	1-3/8"-6 .....	12 .....	108.02
112F2221 .....	Full Length ..	1-3/8"-21 .....	12 .....	125.60
112F2820 .....	Full Length ..	1-3/4"-20 .....	12 .....	113.01

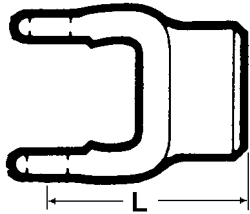

# NEAPCO Driveline Components

## 0675 Series Yokes

Order No.	Old No.	Size/Description	Keyway	Lgth.	Price
NE-10-4373	15-5336	5/8" Rd.	3/16"	2-1/2"	\$26.46
NE-10-0413	15-5111	3/4" Rd.	3/16"	2-1/2"	18.83
NE-10-0313	15-5183	3/4" Rd. Slip Yoke	3/16"	5-1/2"	70.96
NE-10-4173	15-5112	13/16" Rd.	1/4"	2-1/2"	25.90
NE-10-4453	15-5113	7/8" Rd.	1/4"	2-1/2"	42.55
NE-10-0333	15-5184	7/8" Rd. Slip Yoke		5-1/2"	48.93
NE-10-5213	15-5213	7/8" Rd., Double Keyed	3/16"-1/4"	2-1/2"	32.46
NE-10-0473	15-5114	15/16" Rd.	1/4"	2-1/2"	23.58
NE-10-4573	15-5115	1" Rd.	1/4"	2-1/2"	22.95
NE-10-5215	15-5215	1" Rd., Double Keyed	3/16"-1/4"	2-1/2"	27.55
NE-10-0422	15-5171	3/4" Sq.		2-1/2"	25.56
NE-10-1758	15-5148	3/4" Sq. Slip Yoke		5-1/2"	82.43
NE-10-0383	15-5186	1" Rd. Slip Yoke	1/4"	5-1/2"	36.91
NE-10-4163	15-5191	1-1/16" Rd.	1/4"	2-1/2"	27.63
NE-10-4473	15-5116	1-1/8" Rd.	5/16"	2-1/2"	55.76
NE-10-5216	15-5216	1-1/8" Rd., Double Keyed	1/4"-5/16"	2-1/2"	33.61
NE-10-3183	15-5199	1-1/8" Rd. Slip Yoke	5/16"	5-1/2"	63.03
NE-10-5374	15-5217	1-3/16" Rd., Double Keyed	1/4"-5/16"	2-1/2"	55.60
NE-10-4193	15-5118	1-1/4" Rd.	5/16"	2-1/2"	19.42
NE-10-5218	15-5218	1-1/4" Rd., Double Keyed	1/4"-5/16"	2-1/2"	26.58
NE-10-3163	15-5338	1-1/4" Rd. Slip Yoke	5/16"	5-1/2"	54.28
NE-10-3173	15-5376	1-1/4" Rd. Slip Yoke	1/4"	5-1/2"	97.83
NE-10-0412	15-5189	7/8" Sq.		2-1/2"	17.39
NE-10-0452	15-5193	1" Sq.		2-1/2"	21.99
NE-10-0322	15-5178	7/8" Sq. Slip Yoke		5-1/2"	48.80
NE-10-3122	15-5305	1" Sq. Slip Yoke		5-1/2"	57.64
NE-10-1557	15-5138	1-1/8" Sq.		2-1/2"	35.07
NE-10-1769	15-5341	3/4"x7/8" Slip Yoke		5-1/2"	58.04
NE-10-4282	15-5373	7/8" Hex		2-1/2"	23.76
NE-10-3162	15-5377	7/8" Hex Slip Yoke		5-1/2"	47.92
NE-10-0432	15-5172	1-1/8" Hex		2-1/2"	30.45
NE-10-0332	15-5173	1-1/8" Hex Slip Yoke		5-3/16"	33.44
NE-10-5366	15-5366	1" 15 Spl. Quick Detach (Lawn & Garden)		2-13/16"	46.17
NE-10-4139	15-5409	1-3/8" 6 Spl. Quick Detach		3-9/16"	52.08
NE-10-5411	15-5411	1-3/8" 21 Spl. Quick Detach		3-9/16"	144.75
NE-10-5129	15-5129	3/4"x7/8" Rect. Shaft Weld		2-1/2"	57.50
NE-10-5131	15-5131	1"x1-1/8" Rect. Tube Weld		2-3/4"	57.52

## 6N Series Yokes

Order No.	Old No.	Size/Description	Keyway	Lgth.	Price
NE-16-6111	L6111	3/4" Rd.	3/16"	2-1/2"	\$29.35
NE-16-6213	L613A	7/8" Rd., Double Keyed	3/16"-1/4"	2-1/2"	34.90
NE-16-6114	L6114	15/16" Rd.	1/4"	2-1/2"	35.30
NE-16-6215	L615A	1" Rd., Double Keyed	3/16"-1/4"	2-1/2"	27.96
NE-16-6216	L616A	1-1/8" Rd., Double Keyed	1/4"-5/16"	2-1/2"	33.55
NE-16-6217	L617A	1-3/16" Rd.	5/16"	2-1/2"	93.17
NE-16-6218	L618A	1-1/4" Rd., Double Keyed	1/4"-5/16"	2-1/2"	34.24
NE-16-6171	L6171	3/4" Square		2-1/2"	43.89
NE-16-6409	16-6101	1-3/8" x 6 Spl. Quick Detach		3-9/16"	58.02
NE-16-0621	L61U1X	1-3/8" x 21 Spl. Quick Detach		3-9/16"	59.29
NE-16-6129	L6129	3/4"x7/8" Rect. Shaft Weld		2-1/2"	31.88
NE-16-6131	L6131	1"x1-1/8" Rect. Tube Weld		2-3/4"	34.43
NE-16-6132	L6132	Torque Tube Weld Yoke		3"	55.37

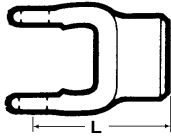

# NEAPCO Driveline Components

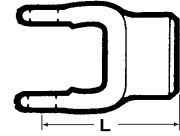

## 12N Series Yokes

Order No.	Old No.	Size/Description	Keyway	Lgth.	Price
NE-12-1133	11133	7/8" Rd.	1/4"	2-3/4"	\$54.62
NE-12-1215		1" Rd. Double Keyed	3/16"-1/4"	3-1/2"	52.96
NE-12-1316	111E5	1" Rd. Slip Yoke	1/4"	5-1/4"	67.13
NE-12-1216		1-1/8" Rd. Double Keyed	1/4"-5/16"	3-1/2"	62.39
NE-12-1118	11118	1-3/16" Rd.	5/16"	3-1/2"	56.90
NE-12-1218	1118A	1-1/4" Rd., Double Keyed	1/4"-5/16"	3-1/2"	48.15
NE-12-1174	11174	1-1/4" Rd. Slip Yoke	5/16"	5-1/4"	63.83
NE-12-1120	11120	1-3/8" Rd.	5/16"	3-1/2"	42.24
NE-12-1175	11175	1-1/2" Rd.	3/8"	2-3/4"	46.40
NE-12-1301		7/8" & 1" Square		3-1/2"	133.53
NE-12-1148	11148	1-1/8" Square		3-1/2"	85.69
NE-12-1168	11168	1-1/8" Hex		2-3/4"	38.21
NE-12-1173	11173	1-1/8" Hex Slip Yoke		5-1/4"	64.81
NE-12-1321	111EY	1-1/4" Square		2-3/4"	53.17
NE-12-1172		1-3/8" 6 Spl. Implement Yoke		3-1/2"	48.63
NE-12-1190	11101X	1-3/8" 6 Spl. Quick Detach		3-5/8"	75.66
NE-12-1193	11193	1-3/8" 21 Spl. Quick Detach		3-5/8"	91.19
NE-12-1340	111P1	1"x1-1/8" Rect. Shaft Weld		2-15/16"	66.98
NE-12-1318	111E8	1-9/32"x1-13/32" Rect. Tube Weld		2-15/16"	65.21
NE-12-1334	111P4	Torque Tube Weld		3-3/4"	93.78

## 14N Series Yokes

Order No.	Old No.	Size/Description	Keyway	Lgth.	Price
NE-20-9115	19115	1" Rd.	1/4"	3-3/4"	\$52.31
NE-20-9117	19117	1-1/8" Rd.	5/16"	3-3/4"	52.29
NE-20-9217	1917A	1-3/16" Rd., Double Keyed	1/4"-5/16"	3-3/4"	125.21
NE-20-9218	1918A	1-1/4" Rd., Double Keyed	1/4"-5/16"	3-3/4"	55.16
NE-20-9120	19120	1-3/8" Rd.	5/16"	3-3/4"	58.48
NE-20-9154	19154	1-7/16" Rd.	3/8"	3-3/4"	64.83
NE-20-9307	191C8	1-1/2" Rd.	3/8"	3-3/4"	49.97
NE-20-9310	191L2	7/8" or 1" Square		3-3/4"	85.40
NE-20-9183	19183	1-1/8" Sq. Bore Yoke		3-3/4"	93.07
NE-20-9127	19127	1-1/4" Sq. Bore Yoke		3-9/16"	93.82
NE-20-9309	20-9101	1-3/8" 6 Spl. Quick Detach		4-13/16"	51.73
NE-20-9325	191N5X	1-3/8" 21 Spl. Quick Detach		4-1/4"	71.02
NE-20-9126	19126	1"x1-1/8" Rect. Shaft Weld		3-3/16"	46.48
NE-20-9129	19129	1"x1-1/8" Rect. Shaft Weld (Phased for Weasler)		3-3/16"	60.53
NE-20-9131	19131	Torque Tube Weld		4"	48.93
NE-20-9313	19313	1-9/32"x1-13/32" Rect. Tube Weld (Phased for Weasler)		3-3/16"	55.24

## 1800 Series Yokes

Order No.	Old No.	Size/Description	Keyway	Lgth.	Price
NE-18-7119	17119	1-1/4" Rd.	5/16"	3-3/4"	\$64.79
NE-18-7120	17120	1-3/8" Rd.	5/16"	3-3/4"	68.61
NE-18-7313	171C8	1-1/2" Rd.	3/8"	3-1/4"	79.95
NE-18-7404		1-3/8" 6 Spl. (Implement End Only)		4-14"	131.94
NE-18-7128	17128	1-1/8" Hexagon		3-3/4"	74.09
NE-18-7125	17125	1" Square		3-5/8"	77.06
NE-18-7127	17127	1-1/4" Square		3-1/4"	98.75
NE-18-7403		1-3/8" 6 Spl. Quick Detach Pin Type (Tractor End)		4-1/4"	80.07
NE-18-7406		1-3/8" 21 Spl. Quick Detach Pin Type (Tractor End)		4-1/4"	174.08
NE-18-7339		1-3/8"-21 Spl. Quick Detach Collar Type (Tractor End)		4-11/32"	107.07
NE-18-7327		1"x1-1/8" Rect. Shaft Weld		3-3/8"	52.21
NE-18-7328		1-9/32"x1-13/32" Rect. Tube Weld		3-3/8"	71.94
NE-18-7305		Torque Tube Weld		3-1/2"	60.90

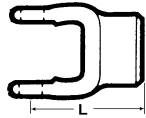

## NEAPCO Driveline Components

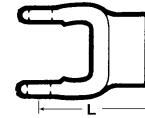

### 35N Series Yokes

Order No.	Old No.	Size/Description	Keyway	Lgth.	Price
NE-22-1131	21131	1" Rd.	1/4"	4-3/16"	\$66.59
NE-22-1132	21132	1-1/8" Rd.	1/4"	4-3/16"	64.77
NE-22-1129	21129	1-3/16" Rd.	1/4"	4-3/16"	61.63
NE-22-1218	2118A	1-1/4" Rd., Double Keyed	1/4"-5/16"	4-3/16"	57.45
NE-22-1219	2119A	1-3/8" Rd., Double Keyed	5/16"-3/8"	4-3/16"	56.45
NE-22-1178	21178	1-7/16" Rd.	3/8"	4-3/16"	66.88
NE-22-1120	21120	1-1/2" Rd.	3/8"	4-3/16"	60.25
NE-22-1338	211V7	1-5/8" Rd.	3/8"	4-3/8"	138.63
NE-22-1316	211D4	1-3/4" Rd.	3/8"	4-3/8"	150.90
NE-22-1125	21125	1" Sq.		4-3/16"	102.68
NE-22-1124	21124	1-1/8" Sq.		4-3/16"	73.38
NE-22-1190	21190	1-3/16" Sq. (Implement End, No Shield Grooves)		4-1/2"	64.35
NE-22-1130	21130	1-1/2" Sq.		4-1/8"	132.55
NE-22-1126	21126	1-5/8" Sq.		4-1/8"	144.65
NE-22-2312	22-1101	1-3/8" 6 Spl. Quick Detach		4-13/16"	60.51
NE-22-1140	21140	1-3/8" 6 Spl. Clamp Type		4-3/4"	78.19
NE-22-2317	211CVX	1-3/8" 21 Spl. Quick Detach		4-13/16"	78.12
NE-22-1105	21105	1-3/8" 21 Spl. Clamp Type		4-3/4"	80.07
NE-22-1344	211Z4	1-3/16" Sq. Shaft Weld		3-5/8"	59.59
NE-22-1325	211F2	Torque Tube Weld (for Std. 2-1/8" O.D. tube w/0.12 wall)		4-1/2"	55.97
NE-22-1307		Torque Tube Weld (for 2-1/8" O.D. tube w/0.083 wall)		4-1/2"	70.06
NE-22-1343		Torque Tube Weld (for 2-1/4" OD Tube)		4-1/2"	56.39
NE-22-2275		1-3/4" 20 Spl. Clamp Type		4-13/16"	159.34

### 44R Series Yokes

Order No.	Old No.	Size/Description	Keyway	Lgth.	Price
NE-44-2256	N44N2256-37	1-3/8" Rd., Double Keyed	1/4" & 5/16"	4-1/8"	\$110.29
NE-44-2456		1-1/2" Rd., Double Keyed	5/16" & 3/8"	4-3/8"	178.72
NE-44-2610	N44RYR26-1	1-5/8" Rd.	3/8"	4-1/8"	104.00
NE-44-2820	N44RYR28-2	1-3/4" Rd.	3/8"	4-1/8"	92.11
NE-44-2220	N44N220-20	1-3/8" 6 Spl. Quick Detach		4-7/8"	102.37
NE-44-4475		1-3/4" 20 Spl. Clamp Type		5"	128.08
NE-44-2201	N44N220-TQD	1-3/8" 21 Spl. Quick Detach		4-7/8"	118.40
NE-44-6300		1-3/4" 20 Spl. Quick Detach		4-7/8"	169.65
NE-44-2100	N44NWY2100	1-5/16" Sq. Shaft Weld		4-1/8"	122.54
NE-44-2200	N44NWY2200	Tube Weld		5-5/16"	116.06

### 55N Series Yokes

Order No.	Old No.	Size/Description	Keyway	Lgth.	Price
NE-55-9306		1-3/8" 6 Spl. Quick Detach		5-13/16"	\$191.21
NE-55-9321		1-3/8" 21 Spl. Quick Detach		5-13/16"	217.75
NE-55-9320		1-3/4" 20 Spl. Quick Detach		6-3/8"	345.25
NE-55-2836		1-3/4" 20 Spl. Clamp Type		5-1/8"	318.98
NE-55-2410		1-1/2" Rd.	3/8"	4-1/16"	182.67
NE-55-2600		1-5/8" Rd.	3/8"	4-1/16"	195.62
NE-55-2800		1-3/4" Rd.	3/8"	4-1/16"	187.74
NE-55-3240		2" Rd.	1/2"	5-9/16"	257.55
NE-55-2130		1-5/16" Sq. Shaft Weld		4-1/2"	199.68
NE-55-3640		Tube Weld		4-3/4"	193.03

### Slip Sleeves

Order No.	Old No.	Hole Dimension	Length	Fits	Price
NE-53-0634	0634-1	3/4"x7/8" Rect.	4"	0675, 6N	\$41.85
NE-53-2034	2034A	1"x1-1/8" Rect.	5"	12N, 14N	46.69
NE-53-2434		1-3/16" Sq.	5"	35N (2-1/4" OD Tube)	64.00
NE-53-2435	2434-20A	1-3/16" Sq.	5"	35N (2-1/8" OD Tube)	55.93
NE-53-2643	2643-14R	1-5/16" Sq.	5"	44R, 55N (2-1/2" OD Tube)	71.25
NE-53-2644	2643-1A	1-5/16" Sq.	5"	44R, 55N (2-3/4" OD Tube)	70.06

**NEAPCO Quick Disconnect Pin Kits**

Order No.	Fits	Price
NE-56-1857	All Standard 1-3/8"-6 Spl. and 21 Spl.	\$10.68
NE-56-2446	All Standard 1-3/4"-20 Spl.	78.06
NE-56-0040	All Metric 1-3/8"-6 Spl. and 21 Spl.	9.32
NE-56-0940	Fits Metric 1-3/4"-20 Spl. Yoke	9.90

Shield No.	Overall Length	Shield Bell O.D.	Inner Tube O.D.	Outer Tube O.D.	Price
NE-69-0648	51"	5-3/16"	2-1/16"	2-5/16"	\$77.43
NE-69-1248	51"	6-1/8"	2-1/2"	2-3/4"	71.31
NE-69-2248	51"	7-3/16"	2-3/4"	3"	98.40
NE-69-2648	51"	7-3/8"	3-7/16"	3-11/16"	159.74

**(See Bearing & Shield Interchange On Next Page)**

Bearing No.	Price	Bearing No.	Price
NE-56-2000	\$11.04	NE-56-6105	\$17.24
NE-56-2200	14.23	NE-56-6106	19.00
NE-56-0844	17.58	NE-56-1600	7.46
NE-56-2600	17.33	NE-56-0600	8.65
NE-56-2101	18.25	NE-56-2122	12.94
NE-56-2102	13.50	NE-56-2223	17.33
NE-56-4103	12.98	NE-56-2324	17.83

Dealer Schedule.....203

**NEAPCO'S WORLD SHIELD**

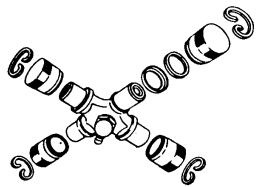
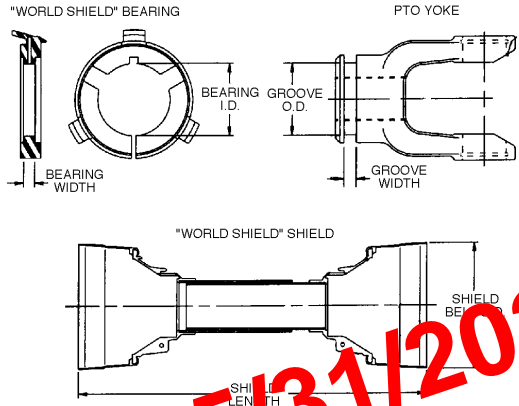

**NEAPCO Journal Assemblies**

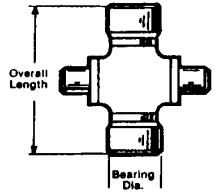

Order No.	Series No.	Rated H.P. @ 540 RPM	Rated H.P. @ 1000 RPM	Overall Lgth.	Journal Lgth.	Journal Diam.	Bearing Diam.	Type*	Price
NE-1-0170	1000	15	24	2-5/16"	2-1/8"	35/64"	15/16"	A	\$19.92
NE-1-1475	6N	15	24	2-5/16"	1-31/32"	35/64"	31/32"	A	18.43
NE-1-1275	12N	25	40	2-9/16"	2-5/16"	41/64"	1-1/16"	A	21.32
NE-1-1875	1800	30	48	3-1/8"	2-7/8"	37/64"	1"	A	24.98
NE-1-2075	14N	35	56	2-5/8"	2-13/32"	23/32"	1-1/8"	B	24.66
NE-2-2275	35N	58	93	3-7/32"	2-15/16"	27/32"	1-1/4"	B	28.72
NE-2-3501**	35N**	58	93	3-7/32"	2-15/16"	27/32"	1-1/4"	A	39.10
NE-3-0044	44R	75	N.A.	4-1/32"	3-3/4"	27/32"	1-5/16"	A	43.74
NE-3-0045	55N	100	N.A.	4-21/64"	4-1/64"	1-1/64"	1-17/32"	B	66.75
NE-3-0188	2600	100	144	4-3/16"	3-7/8"	57/64"	1-3/8"	B	33.57
NE-1-0616	1000 to 6N Kit	15	24	2-5/16"	2-1/16"	35/64"	15/16"-31/32"	A	24.93

\*Type A - Snap Ring Grooves In Bearings, Type B - Snap Ring Grooves In Yokes.

\*\*Internal Snap Rings used on Hovse Mowers.

Dealer Schedule: 1 to 7.....203 8 Or More (Assorted).....203 & 130

**NEAPCO Car & Truck U-Joint Repair Kits**

Order No.	Bearing Diameter	Lock-up Inside	Lock-up Outside	Application	Price
NE-1-0153	1-1/16		3-7/32	60-87 AMC, 73-83 Buick, 55-87 Chevy, 63-68 Ford Car, 49-62 Lincoln, 55-69 & 77-79 Mercury, 70-80 Pontiac, 54-87 Jeep, 55-88 Chevy & GMC Truck, 75-81 Dodge Truck, 53-88 Ford Truck, 55-Present IHC, 38-Present Kenworth, 75-81 Plymouth Truck, 49-Present White Truck	\$15.38
NE-1-0297	1-3/16	2-3/16		80-86 Mercury, 79-88 Jeep, 67-88 Chevy & GMC Truck, 73-88 Dodge Truck, 73-86 Ford Truck, 74-82 IHC, 75-88 Plymouth Truck	32.96
NE-1-0170	15/16	1-1/2		47-Present American La France, 63-81 Dodge Truck	19.92
NE-1-4635	1-1/16-1-1/8	2-3/8	3-7/32	61-80 Ford, 60-80 Mercury	24.68
NE-1-6301	1-5/64	2-1/8		75-78 AMC, 57-88 Chrysler, 66-86 Jeep, 63-88 Dodge Truck, 75-88 Plymouth Truck	19.46
NE-2-0053	1-3/16		3-5/8	84-88 Buick, 82-85 Cadillac, 82-88 Chevy, 77-88 Oldsmobile, 77-88 Pontiac, 47-Present American La France, 55-88 Chevy & GMC Truck, 63-71 Dodge Truck, 53-88 Ford Truck	23.07
NE-2-0054	1-3/16		4-3/16	(Same as #NE-2-0053 shown above.)	28.70
NE-2-3011	1-1/8	2-9/16		57-88 Buick, 57-88 Cadillac, 64-88 Chevy, 57-88 Oldsmobile, 56-88 Pontiac, 67-88 Chevy & GMC Truck, 74-88 Dodge Truck, 75-88 Plymouth Truck	22.01
NE-2-4800	1-1/16	2-25/32	3-5/8	58-62 Cadillac, 65-73 Chrysler, 63-88 Ford, 61-88 Mercury, 68-81 Chevy & GMC Truck, 68-88 Ford Truck	22.11
NE-2-4900	1-1/16-1-1/8	2-25/32	3-5/8	63-80 Ford, 61-79 Mercury, 65-69 Oldsmobile, 73-88 Ford Truck	22.28

Dealer Schedule.....203

**BEARING AND SHIELD INTERCHANGE INFORMATION**

**INDEXED BY BEARING I.D.**

Brg. I.D.	Brg. Width	Brg. Part #	Shield Part #	PTO Manufacturer	PTO Mfg's Series
1-1/2"	9/32"	56-0600	69-0648	Neapco	0600
1-19/32" (1-11/32")	5/32"	56-2101	69-0648	Bondioli & Pavesi	1
1-21/32"	5/32"	56-2122	69-0648	Walterscheid	2100
1-13/16"	9/32"	56-1600	69-0648	G&G Neapco Rockwell Weasler	6N L600 6R 6
1-7/8" (1-19/32")	5/32"	56-2102	69-0648	Bondioli & Pavesi	2
2"	5/32"	56-2223	69-1248	Walterscheid	2200,I,2300
2-1/16"	11/32"	56-2000	69-1248	Agmaster (Walt.) G&G Neapco Rockwell Weasler	1140,1240 12N,14N 1200,1800,2000 12R,14R 12,14
		56-2200	69-2248	Agmaster (Walt.) G&G Neapco Rockwell Weasler	1340 35N 2200 L35N 35
2-3/32" (1-13/16")	5/32"	56-4103	69-1248	Bondioli & Pavesi	3,4
2-15/32" (2-3/32")	5/32"	56-6105	69-2248	Bondioli & Pavesi	5
2-1/2"	3/16"	56-2324	69-2248	Walterscheid	2400
2-5/8"	13/32"	56-0844	69-2648	Agmaster (Walt.) G&G Neapco Rockwell Weasler	1440 44N N44 44R 44
2-11/16" (2-11/32")	5/32"	56-6106	69-2248	Bondioli & Pavesi	6
2-7/8"	11/32"	56-2600	69-2648	Agmaster (Walt.) Neapco	1480 2600

Dimensions in parenthesis denote bearing groove O.D. of inner yoke/tube assembly VS. bearing groove O.D. of outer yoke/tube assembly.

**INDEXED BY PTO MANUFACTURER & SERIES**

PTO Manufacturer	PTO Mfg's Series	Bearing Part #	Groove O.D.	Groove Width	Shield Part #
Agmaster (Walt.)	1140,1240 1340 1440 1480	56-2000 56-2200 56-0844 56-2600	2-1/16" 2-1/16" 2-5/8" 2-7/8"	11/32" 11/32" 13/32" 11/32"	69-1248 69-2248 69-2648 69-2648
Bondioli & Pavesi	1 2 3,4 5 6	56-2101 56-2102 56-4103 56-6105 56-6106	1-19/32" 1-7/8" 2-3/32" 2-15/32" 2-11/16"	5/32" 5/32" 5/32" 5/32" 5/32"	69-0648 69-0648 69-1248 69-2248 69-2248
G&G	6N 12N,14N 35N 44N	56-1600 56-2000 56-2200 56-0844	1-13/16" 2-1/16" 2-1/16" 2-5/8"	5/16" 3/8" 3/8" 7/16"	69-0648 69-1248 69-2248 69-2648
Neapco	0600 L600 1200,1800,2000 2200 2600 N44	56-0600 56-1600 56-2000 56-2200 56-2600 56-0844	1-1/2" 1-13/16" 2-1/16" 2-1/16" 2-7/8" 2-5/8"	5/16" 5/16" 11/32" 11/32" 11/32" 13/32"	69-0648 69-0648 69-1248 69-2248 69-2648 69-2648
Rockwell	6R 12R,14R 35R 44R	56-1600 56-2000 56-2200 56-0844	1-13/16" 2-1/16" 2-1/16" 2-5/8"	5/16" 11/32" 11/32" 13/32"	69-0648 69-1248 69-2248 69-2648
Walterscheid	2100 2200,I,2300 2400	56-2122 56-2223 56-2324	1-5/8" 1-31/32" 2-15/32"	5/32" 7/32" 7/32"	69-0648 69-1248 69-2248
Weasler	6 12,14 35 44	56-1600 56-2000 56-2200 56-0844	1-13/16" 2-1/16" 2-1/16" 2-5/8"	5/16" 11/32" 11/32" 13/32"	69-0648 69-1248 69-2248 69-2648

Dimensions in parenthesis denote bearing groove O.D. of inner yoke/tube assembly VS. bearing groove O.D. of outer yoke/tube assembly.

**Neapco Metric Journal Assembly Specifications**

Part Number	Style	Series Number	Rated H.P. @540 RPM	Rated H.P. @1000 RPM	Overall Length	Bearing Diameter
NE-1-0121	Bondioli & Pavesi	1	15	24	2-1/8" (54.0 MM)	7/8" (22.0 MM)
NE-1-0221	Bondioli & Pavesi	2	15	24	2-13/32" (61.3 MM)	15/16" (23.8 MM)
NE-1-0321	Bondioli & Pavesi	3	25	40	2-3/4" (70.0 MM)	1-1/16" (27.0 MM)
NE-1-0421	Bondioli & Pavesi	4	30	48	2-15/16" (74.6 MM)	1-1/16" (27.0 MM)
NE-2-0521	Bondioli & Pavesi	5	58	93	3-5/32" (80.0 MM)	1-3/16" (30.2 MM)
NE-3-0621	Bondioli & Pavesi	6	58	93	3-5/8" (92.0 MM)	1-3/16" (30.2 MM)
NE-3-0721	Bondioli & Pavesi	7	100	144	3-11/16" (94.0 MM)	1-3/8" (35.0 MM)
NE-3-0821	Bondioli & Pavesi	8	100	144	4-3/16" (106.5 MM)	1-3/8" (35.0 MM)
NE-1-1001	Walterscheid	2100	15	24	2-11/64" (55.0 MM)	7/8" (22.0 MM)
NE-1-0221	Walterscheid	2200	15	24	2-13/32" (61.3 MM)	15/16" (23.8 MM)
NE-1-0321	Walterscheid	I	30	48	2-3/4" (70.0 MM)	1-1/16" (27.0 MM)
NE-1-0421	Walterscheid	2300	30	48	2-15/16" (74.6 MM)	1-1/16" (27.0 MM)
NE-2-2421	Walterscheid	2400	58	93	3" (76.0 MM)	1-17/64" (32.0 MM)
NE-3-2521	Walterscheid	2500	75	100	3-1/2" (89.0 MM)	1.417" (36.0 MM)

ALL PRICES SUBJECT TO CHANGE WITHOUT NOTICE.

# 1 Series - Neapco Metric Series - Bondioli & Pavesi Style

## Cross & Bearing Kit: Outside Lock-Up

Part No.	Bearing Diameter (B)		Overall length (L)		Price
	mm	inches	mm	inches	
NE-1-0121	22.0	7/8	54.0	2-1/8	\$25.00

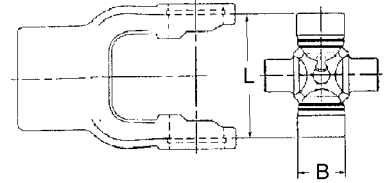

## Tractor Yokes: Pin Type Quick Disconnect (tractor end use only)

Part No.	Bore	Length (L)		Price
		mm	inches	
NE-8-1012	1-3/8"-6 Spline	92.00	3-5/8	\$43.41
NE-8-1021	1-3/8"-21 Spline	92.00	3-5/8	50.60

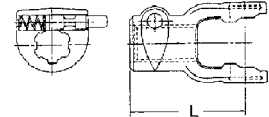

## Inner Profile Yoke

Part No.	Bore		Length (L)		Use with Tube No.	Price
	mm	inches	mm	inches		
NE-8-1030	26.5	1-1/32	80.0	3-1/8	NE-70-0105	\$44.16

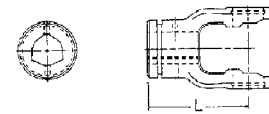

## Inner Profile Tube - 59" Length (L)

Part No.	O.D.		Wall Thickness		Use with Yoke No.	Price
	mm	inches	mm	inches		
NE-70-0105	26.5	1-1/32	3.5	9/64	NE-8-1030	\$68.80

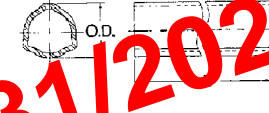

## Outer Profile Yoke

Part No.	Bore		Length (L)		Use with Tube No.	Price
	mm	inches	mm	inches		
NE-8-1020	32.5	1-9/32	80.0	3-1/8	NE-70-0104	\$44.27

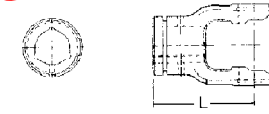

## Outer Profile Tube - 59" Length (L)

Part No.	O.D.		Wall Thickness		Use with Yoke No.	Price
	mm	inches	mm	inches		
NE-70-0104	32.5	1-9/32	2.6	7/64	NE-8-1020	\$65.08

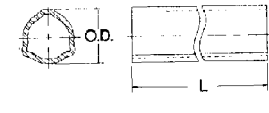

## Tube Pin (Fits both inner and outer profile yokes)

Part No.	Diameter		Length (L)		Price
	mm	inches	mm	inches	
NE-50-0412	8.0	5/16	60.3	2-3/8	\$15.88



## Implement Yokes

Part No.	Bore		Length (L)		Keyway	Hole Size	Price
	mm	inches	mm	inches			
NE-8-1008	25.4	1	78.0	3-1/16	1/4"	3/8"-16	\$52.61
NE-8-1010	31.75	1-1/4	78.0	3-1/16	1/4"	3/8"-16	51.71

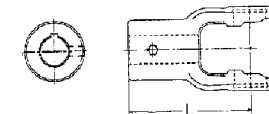

## World Shield - Plastic

Part No.	Overall Length	Bell O.D.	Price
NE-69-0648	51"	5-1/4"	\$77.43

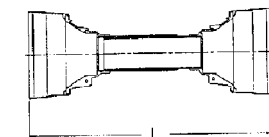

## Shield Bearing Set (2 per box)

Part No.	Bearing I.D.		Bearing Width	Use With Shield No.	Price
	Outer	Inner			
NE-56-2101	1-19/32"	1-11/32"	5/32"	NE-69-0648	\$18.25

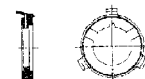

NEW PRICES AS OF 5/31/2021

## 2 Series - Neapco Metric Series - Bondioli & Pavesi Style

### Cross & Bearing Kit: Outside Lock-Up

Part No.	Bearing Diameter (B)		Overall length (L)		Price
	mm	inches	mm	inches	
NE-1-0221	23.8	15/16	61.3	2-13/32	\$27.94

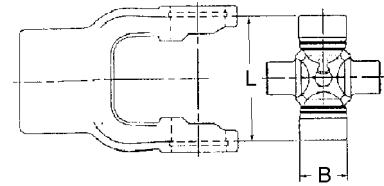

### Tractor Yokes: Pin Type Quick Disconnect (tractor end use only)

Part No.	Bore	Length (L)		Price
		mm	inches	
NE-8-2012	1-3/8"-6 Spline	98.00	3-7/8	\$57.33
NE-8-2021	1-3/8"-21 Spline	98.00	3-7/8	63.22

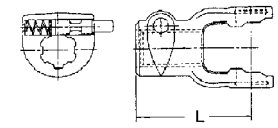

### Inner Profile Yoke

Part No.	Bore		Length (L)		Use with Tube No.	Price
	mm	inches	mm	inches		
NE-8-2030	29.0	1-9/64	84.0	3-5/16	NE-70-0205	\$51.18

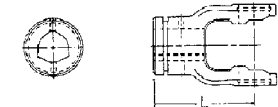

### Inner Profile Tube - 59" Length (L)

Part No.	O.D.		Wall Thickness		Use with Yoke No.	Price
	mm	inches	mm	inches		
NE-70-0205	29.0	1-9/64	4.0	5/32	NE-8-2030	\$72.50

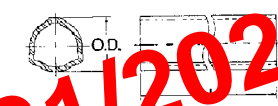

### Outer Profile Yoke

Part No.	Bore		Length (L)		Use with Tube No.	Price
	mm	inches	mm	inches		
NE-8-2020	36.0	1-13/32	84.0	3-5/16	NE-70-0305	\$53.32

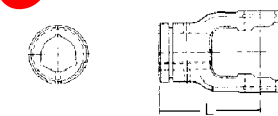

### Outer Profile Tube - 59" Length (L)

Part No.	O.D.		Wall Thickness		Use with Yoke No.	Price
	mm	inches	mm	inches		
NE-70-0305	36.0	1-13/32	3.2	1/8	NE-8-2020	\$80.13

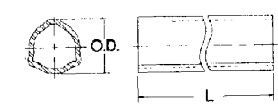

### Tube Pin (Fits both inner and outer profile yokes)

Part No.	Diameter		Length (L)		Price
	mm	inches	mm	inches	
NE-50-0412	8.0	5/16	60.3	2-3/8	\$15.88

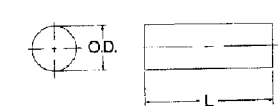

### Implement Yokes

Part No.	Bore		Length (L)		Keyway	Hole Size	Price
	mm	inches	mm	inches			
NE-8-2008	25.4	1	80.0	3-5/32	1/4"	3/8"-16	\$64.20
NE-8-2010	31.75	1-1/4	80.0	3-5/32	1/4"	3/8"-16	55.72

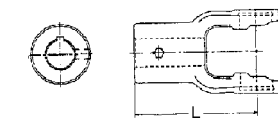

### World Shield - Plastic

Part No.	Overall Length	Bell O.D.	Price
NE-69-0648	51"	5-1/4"	\$77.43

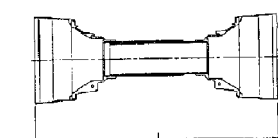

### Shield Bearing Set (2 per box)

Part No.	Bearing I.D.	Bearing Width	Use With Shield No.	Price
NE-56-2102	1-7/8"	5/32"	NE-69-0648	\$13.50
	1-19/32"	5/32"		

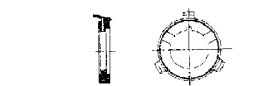

### PTO Drive Shaft Assemblies (Less Equipment End Yoke)

Part No.	A	B	Tractor QD Yoke	Price
NE-8-0100	39.76"	43.58"	1-3/8"-6 Spl.	\$198.32
NE-8-0101	51.57"	55.39"	1-3/8"-6 Spl.	217.78

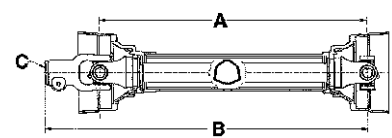

NEW PRICES AS OF 5/31/2021



### 3 Series - Neapco Metric Series - Bondioli & Pavesi Style

**Cross & Bearing Kit: Outside Lock-Up**

Part No.	Bearing Diameter (B)		Overall length (L)		Price
	mm	inches	mm	inches	
NE-1-0321	27.0	1-1/16	70.0	2-3/4	\$35.68

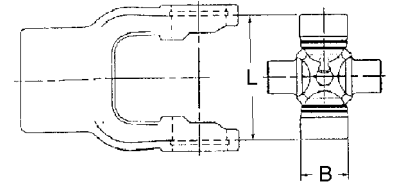

**Tractor Yokes: Pin Type Quick Disconnect (tractor end use only)**

Part No.	Bore	Length (L)		Price
		mm	inches	
NE-8-3012	1-3/8"-6 Spline	104.00	4-3/32	\$58.98
NE-8-3021	1-3/8"-21 Spline	95.00	3-3/4	68.97

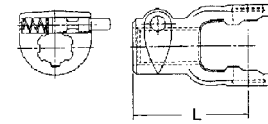

**Inner Profile Yoke**

Part No.	Bore		Length (L)		Use with Tube No.	Price
	mm	inches	mm	inches		
NE-8-3030	36.0	1-27/64	80.0	3-5/32	NE-70-0305	\$58.62

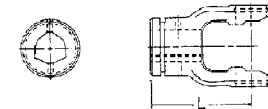

**Inner Profile Tube - 59" Length (L)**

Part No.	O.D.		Wall Thickness		Use with Yoke No.	Price
	mm	inches	mm	inches		
NE-70-0305	36.0	1-27/64	3.2	1/8	NE-8-3030	\$80.13



**Outer Profile Yoke**

Part No.	Bore		Length (L)		Use with Tube No.	Price
	mm	inches	mm	inches		
NE-8-3020	43.5	1-11/16	80.0	3-5/32	NE-70-0304	\$58.88

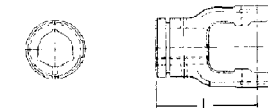

**Outer Profile Tube - 59" Length (L)**

Part No.	O.D.		Wall Thickness		Use with Yoke No.	Price
	mm	inches	mm	inches		
NE-70-0304	43.5	1-11/16	3.4	9/64	NE-8-3020	\$90.54



**Tube Pin (Fits both inner and outer profile yokes)**

Part No.	Diameter		Length (L)		Price
	mm	inches	mm	inches	
NE-50-0412	8.0	5/16	60.3	2-3/8	\$15.88



**Implement Yokes**

Part No.	Bore		Length (L)		Keyway	Hole Size	Price
	mm	inches	mm	inches			
NE-8-3011	25.4	1	92.0	3-5/8	1/4"	3/8"-16	\$60.23
NE-8-3010	31.75	1-1/4	92.0	3-5/8	1/4"	3/8"-16	58.98
NE-8-3016	34.93	1-3/8	92.0	3-5/8		3/8" D.T.	131.82

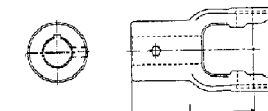

**World Shield - Plastic**

Part No.	Overall Length	Bell O.D.	Price
NE-69-1248	51"	6-1/8"	\$71.31

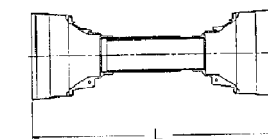

**Shield Bearing Set (2 per box)**

Part No.	Bearing		Use With Shield No.	Price
	Bearing I.D.	Width		
NE-56-4103	Outer 2-3/32"	5/32"	NE-69-1248	\$12.98
	Inner 1-13/16"	5/32"		

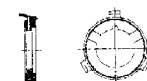

**PTO Drive Shaft Assemblies (Less Equipment End Yoke)**

Part No.	A	B	Tractor QD Yoke	Price
NE-8-0102	41.73"	45.75"	1-3/8"-6 Spl. ...	\$225.89
NE-8-0103	53.54"	57.56"	1-3/8"-6 Spl. ...	246.03

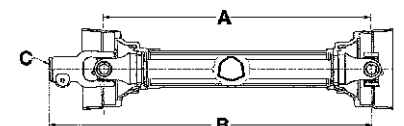

NEW PRICES AS OF 5/31/2021

# 4 Series - Neapco Metric Series - Bondioli & Pavesi Style

### Cross & Bearing Kit: Outside Lock-Up

Part No.	Bearing Diameter (B)		Overall length (L)		Price
	mm	inches	mm	inches	
NE-1-0421	27.0	1-1/16	74.6	2-15/16	\$34.38

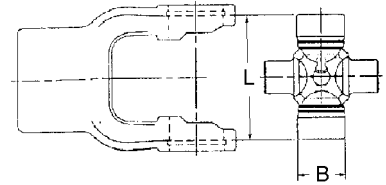

### Tractor Yokes: Pin Type Quick Disconnect (tractor end use only)

Part No.	Bore	Length (L)		Price
		mm	inches	
NE-8-4012	1-3/8"-6 Spline	107.00	4-7/32	\$64.00
NE-8-4021	1-3/8"-21 Spline	107.00	4-7/32	80.86

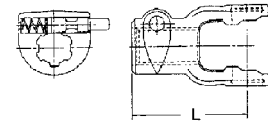

### Inner Profile Yoke

Part No.	Bore		Length (L)		Use with Tube No.	Price
	mm	inches	mm	inches		
NE-8-4030	36.0	1-27/64	93.5	3-11/16	NE-70-0405	\$65.52

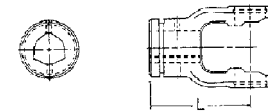

### Inner Profile Tube - 59" Length (L)

Part No.	O.D.		Wall Thickness		Use with Yoke No.	Price
	mm	inches	mm	inches		
NE-70-0405	36.0	1-27/64	4.5	11/64	NE-8-4030	\$104.00



### Outer Profile Yoke

Part No.	Bore		Length (L)		Use with Tube No.	Price
	mm	inches	mm	inches		
NE-8-4020	43.5	1-11/16	93.5	3-11/16	NE-70-0304	\$65.52

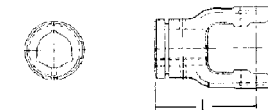

### Outer Profile Tube - 59" Length (L)

Part No.	O.D.		Wall Thickness		Use with Yoke No.	Price
	mm	inches	mm	inches		
NE-70-0304	43.5	1-11/16	3.4	9/64	NE-8-4020	\$90.54



### Tube Pin (Fits both inner and outer profile yokes)

Part No.	Diameter		Length (L)		Price
	mm	inches	mm	inches	
NE-50-0412	8.0	5/16	60.3	2-3/8	\$15.88



### Implement Yokes

Part No.	Bore		Length (L)		Keyway	Hole Size	Price
	mm	inches	mm	inches			
NE-8-4010	31.75	1-1/4	95.0	3-3/4	1/4"	3/8"-16	\$65.23
NE-8-4011	34.93	1-3/8	95.0	3-3/4	5/16"	3/8"-16	66.61
NE-8-4016	34.93	1-3/8	89.5	3-17/32		3/8" D.T.	96.54

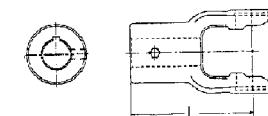

### World Shield - Plastic

Part No.	Overall Length	Bell O.D.	Price
NE-69-1248	51"	6-1/8"	\$71.31

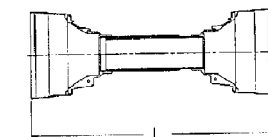

### Shield Bearing Set (2 per box)

Part No.	Bearing I.D.		Bearing Width	Use With Shield No.	Price
	Outer	Inner			
NE-56-4103	2-3/32"	1-13/16"	5/32"	NE-69-1248	\$12.98

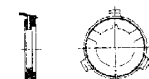

### PTO Drive Shaft Assemblies (Less Equipment End Yoke)

Part No.	A	B	Tractor QD Yoke	Price
NE-8-0104	41.73"	46.02"	1-3/8"-6 Spl. ...	\$228.46
NE-8-0105	53.54"	57.83"	1-3/8"-6 Spl. ...	249.69

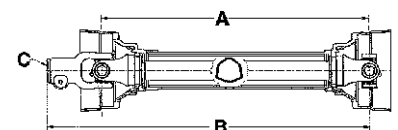

NEW PRICES AS OF 5/31/2021

# 5 Series - Neapco Metric Series - Bondioli & Pavesi Style

### Cross & Bearing Kit: Outside Lock-Up

Part No.	Bearing Diameter (B)		Overall length (L)		Price
	mm	inches	mm	inches	
NE-2-0521	30.2	1-3/16	80.0	3-5/32	\$47.09

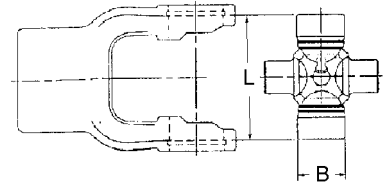

### Tractor Yokes: Pin Type Quick Disconnect (tractor end use only)

Part No.	Bore	Length (L)		Price
		mm	inches	
NE-8-5012	1-3/8"-6 Spline	111.00	4-3/8	\$81.53
NE-8-5021	1-3/8"-21 Spline	111.00	4-3/8	105.15

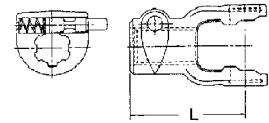

### Inner Profile Yoke

Part No.	Bore		Length (L)		Use with Tube No.	Price
	mm	inches	mm	inches		
NE-8-5030	45.0	1-25/32	98.5	3-7/8	NE-70-0505	\$93.92

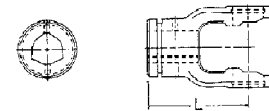

### Inner Profile Tube - 59" Length (L)

Part No.	O.D.		Wall Thickness		Use with Yoke No.	Price
	mm	inches	mm	inches		
NE-70-0505	45.0	1-25/32	4.0	5/32	NE-8-5030	\$119.55

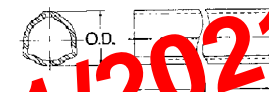

### Outer Profile Yoke

Part No.	Bore		Length (L)		Use with Tube No.	Price
	mm	inches	mm	inches		
NE-8-5020	51.6	2-1/32	98.5	3-7/8	NE-70-0504	\$93.63

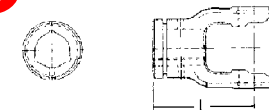

### Outer Profile Tube - 59" Length (L)

Part No.	O.D.		Wall Thickness		Use with Yoke No.	Price
	mm	inches	mm	inches		
NE-70-0504	51.6	2-1/32	3.0	1/8	NE-8-5020	\$105.25



### Tube Pin (Fits both inner and outer profile yokes)

Part No.	Diameter		Length (L)		Price
	mm	inches	mm	inches	
NE-50-0612	10.0	25/64	70.0	2-3/4	\$32.52



### Implement Yokes

Part No.	Bore		Length (L)		Keyway	Hole Size	Price
	mm	inches	mm	inches			
NE-8-5010	31.75	1-1/4	98.0	3-27/32	1/4"	3/8"-16	\$96.79
NE-8-5011	34.93	1-3/8	98.0	3-27/34	5/16"	3/8"-16	96.79
NE-8-5016	34.93	1-3/8	98.0	3-27/32		3/8" D.T.	101.53

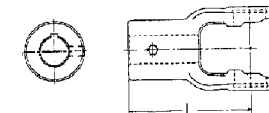

### World Shield - Plastic

Part No.	Overall Length	Bell O.D.	Price
NE-69-2248	51"	7-1/16"	\$98.40

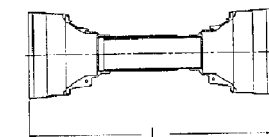

### Shield Bearing Set (2 per box)

Part No.	Bearing		Use With Shield No.	Price
	Bearing I.D.	Width		
NE-56-6105	Outer 2-15/32"	5/32"	NE-69-2248	\$17.24
	Inner 2-3/32"	5/32"		

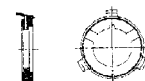

### PTO Drive Shaft Assemblies (Less Equipment End Yoke)

Part No.	A	B	Tractor QD Yoke	Price
NE-8-0106	39.76"	44.17"	1-3/8"-6 Spl.	\$286.41
NE-8-0107	51.57"	55.98"	1-3/8"-6 Spl.	300.96

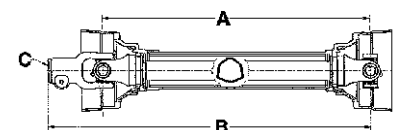

NEW PRICES AS OF 5/31/2021

# 6 Series - Neapco Metric Series - Bondioli & Pavesi Style

### Cross & Bearing Kit: Outside Lock-Up

Part No.	Bearing Diameter (B)		Overall length (L)		Price
	mm	inches	mm	inches	
NE-3-0621	30.2	1-3/16	92.0	3-5/8	\$43.51

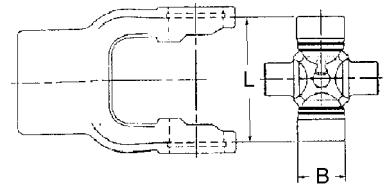

### Tractor Yokes: Pin Type Quick Disconnect (tractor end use only)

Part No.	Bore	Length (L)		Price
		mm	inches	
NE-8-6012	1-3/8"-6 Spline	118.00	4-21/32	\$98.15
NE-8-6021	1-3/8"-21 Spline	118.00	4-21/32	101.82

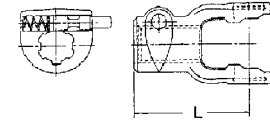

### Inner Profile Yoke

Part No.	Bore		Length (L)		Use with Tube No.	Price
	mm	inches	mm	inches		
NE-8-6030	45.0	1-25/32	107.0	4-7/32	NE-70-0505	\$93.55

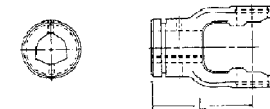

### Inner Profile Tube - 59" Length (L)

Part No.	O.D.		Wall Thickness		Use with Yoke No.	Price
	mm	inches	mm	inches		
NE-70-0505	45.0	1-25/32	4.0	5/32	NE-8-6030	\$119.55



### Outer Profile Yoke

Part No.	Bore		Length (L)		Use with Tube No.	Price
	mm	inches	mm	inches		
NE-8-6020	54.0	2-1/8	107.0	4-7/32	NE-70-0704	\$104.86

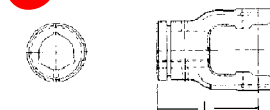

### Outer Profile Tube - 59" Length (L)

Part No.	O.D.		Wall Thickness		Use with Yoke No.	Price
	mm	inches	mm	inches		
NE-70-0704	54.0	2-1/8	4.0	5/32	NE-8-6020	\$137.12

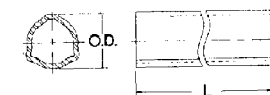

### Tube Pin (Fits both inner and outer profile yokes)

Part No.	Diameter		Length (L)		Price
	mm	inches	mm	inches	
NE-50-0612	10.0	25/64	70.0	2-3/4	\$32.52



### Implement Yokes

Part No.	Bore		Length (L)		Keyway	Hole Size	Price
	mm	inches	mm	inches			
NE-8-6010	31.75	1-1/4	105.0	4-9/64	1/4"	3/8"-16	\$104.59
NE-8-6011	34.93	1-3/8	105.0	4-9/64	5/16"	3/8"-16	96.01
NE-8-6016	34.93	1-3/8	105.0	4-9/64		3/8" D.T.	94.59

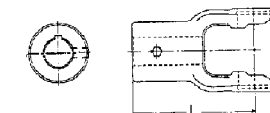

### World Shield - Plastic

Part No.	Overall Length	Bell O.D.	Price
NE-69-2248	51"	7-1/16"	\$98.40

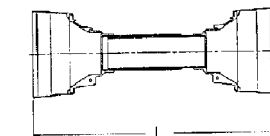

### Shield Bearing Set (2 per box)

Part No.	Bearing I.D.	Bearing Width	Use With Shield No.	Price
NE-56-6106	Outer 2-11/16"	5/32"	NE-69-2248	\$19.00
	Inner 2-11/32"	5/32"		

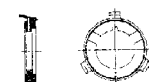

### PTO Drive Shaft Assemblies (Less Equipment End Yoke)

Part No.	A	B	Tractor QD Yoke	Price
NE-8-0108	39.76"	44.17"	1-3/8"-6 Spl. ...	\$326.63
NE-8-0109	51.57"	56.38"	1-3/8"-6 Spl. ...	349.07

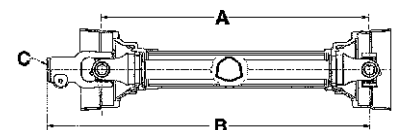

NEW PRICES AS OF 5/31/2021

# 7 Series - Neapco Metric Series - Bondioli & Pavesi Style

### Cross & Bearing Kit: Outside Lock-Up

Part No.	Bearing Diameter (B)		Overall length (L)		Price
	mm	inches	mm	inches	
NE-3-0721	35.0	1-3/8	94.0	3-11/16	\$82.47

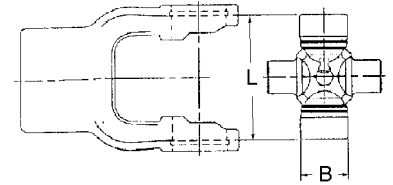

### Tractor Yokes: Pin Type Quick Disconnect (tractor end use only)

Part No.	Bore	Length (L)		Price
		mm	inches	
NE-8-7012	1-3/8"-6 Spline	122.00	4-13/16	\$110.58
NE-8-7021	1-3/8"-21 Spline	122.00	4-13/16	114.41
NE-8-7014	1-3/4"-20 Spline	122.00	4-13/16	124.84

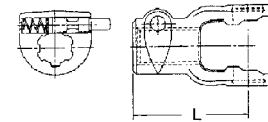

### Inner Profile Yoke

Part No.	Bore		Length (L)		Use with Tube No.	Price
	mm	inches	mm	inches		
NE-8-7030	45.0	1-3/4	110.0	4-7/32	NE-70-0705	\$102.97

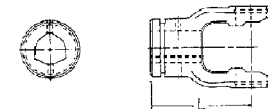

### Inner Profile Tube - 59" Length (L)

Part No.	O.D.		Wall Thickness		Use with Yoke No.	Price
	mm	inches	mm	inches		
NE-70-0705	45.0	1-3/4	5.5	7/32	NE-8-7030	\$213.97

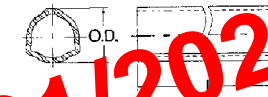

### Outer Profile Yoke

Part No.	Bore		Length (L)		Use with Tube No.	Price
	mm	inches	mm	inches		
NE-8-7020	54.0	2-1/8	107.0	4-7/32	NE-70-0704	\$102.97

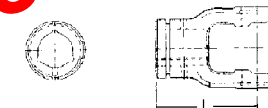

### Outer Profile Tube - 59" Length (L)

Part No.	O.D.		Wall Thickness		Use with Yoke No.	Price
	mm	inches	mm	inches		
NE-70-0704	54.0	2-1/8	4.0	5/32	NE-8-7020	\$137.12



### Tube Pin (Fits both inner and outer profile yokes)

Part No.	Diameter		Length (L)		Price
	mm	inches	mm	inches	
NE-50-1080	10.0	25/64	80.0	3-5/32	\$27.04



### Implement Yokes

Part No.	Bore		Length (L)		Keyway	Hole Size	Price
	mm	inches	mm	inches			
NE-8-7011	35.0	1-3/8	110.0	4-5/16	5/16"	3/8"-16	\$88.34

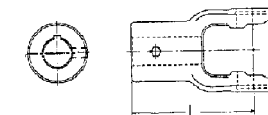

### World Shield - Plastic

Part No.	Overall Length	Bell O.D.	Price
NE-69-2248	51"	7-1/16"	\$98.40

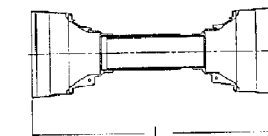

### Shield Bearing Set (2 per box)

Part No.	Bearing I.D.		Bearing Width	Use With Shield No.	Price
	Outer	Inner			
NE-56-6106	2-11/16"	2-11/32"	5/32"	NE-69-2248	\$19.00

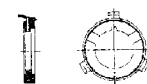

### PTO Drive Shaft Assemblies (Less Equipment End Yoke)

Part No.	A	B	Tractor QD Yoke	Price
NE-8-0110	39.76"	44.17"	1-3/8"-6 Spl.	\$394.26
NE-8-0111	51.57"	56.38"	1-3/8"-6 Spl.	436.98

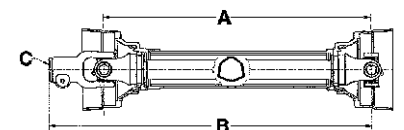

NEW PRICES AS OF 5/31/2021

# 8 Series - Neapco Metric Series - Bondioli & Pavesi Style

## Cross & Bearing Kit: Outside Lock-Up

Part No.	Bearing Diameter (B)		Overall length (L)		Price
	mm	inches	mm	inches	
NE-3-0821	35.0	1-3/8	106.5	4-3/16	\$60.76

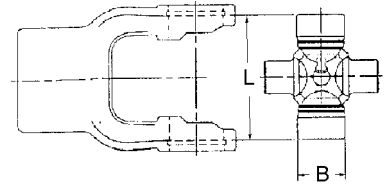

## Tractor Yokes: Pin Type Quick Disconnect (tractor end use only)

Part No.	Bore	Length (L)		Price
		mm	inches	
NE-8-8012	1-3/8"-6 Spline	126.00	4-31/32	\$136.21
NE-8-8021	1-3/8"-21 Spline	126.00	4-31/32	143.92
NE-8-8014	1-3/4"-20 Spline	126.00	4-31/32	149.60

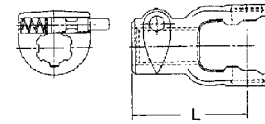

## Inner Profile Yoke

Part No.	Bore		Length (L)		Use with Tube No.	Price
	mm	inches	mm	inches		
NE-8-8030	54.0	2-1/8	120.0	4-23/32	NE-70-0704	\$119.72

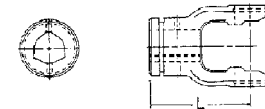

## Inner Profile Tube - 59" Length (L)

Part No.	O.D.		Wall Thickness		Use with Yoke No.	Price
	mm	inches	mm	inches		
NE-70-0704	54.0	2-1/8	4.0	5/32	NE-8-8030	\$137.12

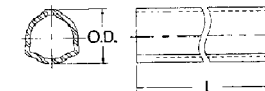

## Outer Profile Yoke

Part No.	Bore		Length (L)		Use with Tube No.	Price
	mm	inches	mm	inches		
NE-8-8020	63.0	2-1/2	120.0	4-23/32	NE-70-0804	\$136.29



## Outer Profile Tube - 59" Length (L)

Part No.	O.D.		Wall Thickness		Use with Yoke No.	Price
	mm	inches	mm	inches		
NE-70-0804	63.0	2-1/2	4.0	5/32	NE-8-8020	\$239.35



## Tube Pin (Fits both inner and outer profile yokes)

Part No.	Diameter		Length (L)		Price
	mm	inches	mm	inches	
NE-50-1280	12.0	15/32	80.0	3-5/32	\$51.50



## Implement Yokes

Part No.	Bore		Length (L)		Keyway	Hole Size	Price
	mm	inches	mm	inches			
NE-8-8011	35.0	1-3/8	120.0	4-23/32	5/16"	3/8"-16	\$130.52
NE-8-8015	38.0	1-1/2	120.0	4-23/32	5/16"	3/8"-16	132.99
NE-8-8016	44.5	1-3/4	120.0	4-23/32	3/8"	3/8"-16	139.15

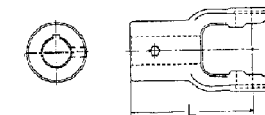

## World Shield - Plastic

Part No.	Overall Length	Bell O.D.	Price
NE-69-2648	51"	8"	\$159.74

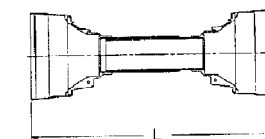

## Shield Bearing Set (2 per box)

Part No.	Bearing I.D.		Bearing Width	Use With Shield No.	Price
	Outer	Inner			
NE-56-8108	3-3/16"	2-11/16"	1/4"	NE-69-2648	\$24.18

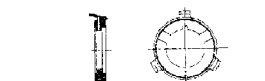

## PTO Drive Shaft Assemblies (Less Equipment End Yoke)

Part No.	A	B	Tractor QD Yoke	Price
NE-8-0112	37.80"	42.72"	1-3/8"-6 Spl. ...	\$662.26
NE-8-0113	49.61"	54.53"	1-3/8"-6 Spl. ...	715.32

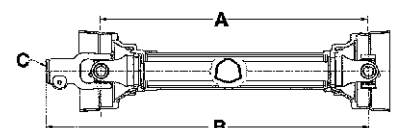

NEW PRICES AS OF 5/31/2021

# 2100 Series - Neapco Metric Series - Walterscheid Style

### Cross & Bearing Kit: Outside Lock-Up

Part No.	Bearing Diameter (B)		Overall length (L)		Price
	mm	inches	mm	inches	
NE-1-1001	22.0	7/8	55.0	2-11/64	\$25.75

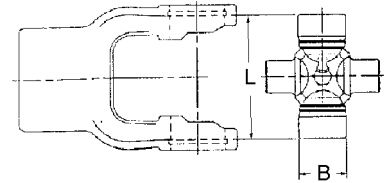

### Tractor Yokes: Pin Type Quick Disconnect (tractor end use only)

Part No.	Bore	Length (L)		Price
		mm	inches	
NE-8-2112	1-3/8"-6 Spline	89.0	3-1/2	\$43.56
NE-8-2121	1-3/8"-21 Spline	89.0	3-1/2	61.80

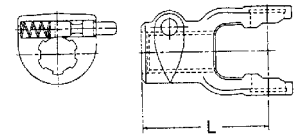

### Inner Profile Yoke

Part No.	Bore		Length (L)		Use with Tube No.	Price
	mm	inches	mm	inches		
NE-8-2130	23.5	59/64	66.0	2-19/32	NE-70-2105	\$44.87

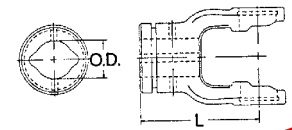

### Inner Profile Tube - 59" Length (L)

Part No.	O.D.		Wall Thickness		Use with Yoke No.	Price
	mm	inches	mm	inches		
NE-70-2105	23.5	59/64	3.6	9/64	NE-8-2130	\$104.27



### Outer Profile Yoke

Part No.	Bore		Length (L)		Use with Tube No.	Price
	mm	inches	mm	inches		
NE-8-2120	30.0	1-3/16	66.0	2-19/32	NE-70-2104	\$51.54

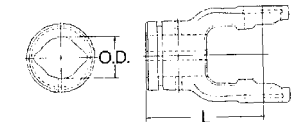

### Outer Profile Tube - 59" Length (L)

Part No.	O.D.		Wall Thickness		Use with Yoke No.	Price
	mm	inches	mm	inches		
NE-70-2104	30.0	1-3/16	2.85	7/64	NE-8-2120	\$66.55



### Tube Pin (Fits both inner and outer profile yokes)

Part No.	Diameter		Length (L)		Price
	mm	inches	mm	inches	
NE-50-0112	8.0	5/16	50.0	1-31/32	\$18.06

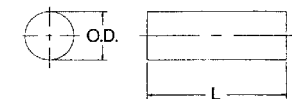

### Implement Yokes

Part No.	Bore		Length (L)		Hole Size	Price
	mm	inches	mm	inches		
NE-8-2108	25.4	1	78.0	3-5/64	5/16" D.T.	\$61.88
NE-8-2110	31.75	1-1/4	78.0	3-5/64	3/8" D.T.	49.99

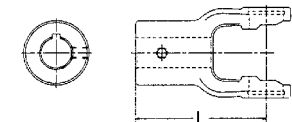

### World Shield - Plastic

Part No.	Overall Length	Bell O.D.	Price
NE-69-0648	51"	5-1/4"	\$77.43

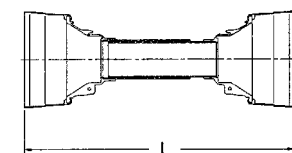

### Shield Bearing Set (2 per box)

Part No.	Bearing I.D.	Bearing Width	Use With Shield No.	Price
NE-56-2122	1-21/32"	5/32"	NE-69-0648	\$12.94

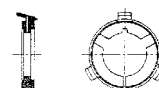

NEW PRICES AS OF 5/31/2021

# 2200 Series - Neapco Metric Series - Walterscheid Style

### Cross & Bearing Kit: Outside Lock-Up

Part No.	Bearing Diameter (B)		Overall length (L)		Price
	mm	inches	mm	inches	
NE-1-0221	23.8	15/16	61.3	2-13/32	\$27.94

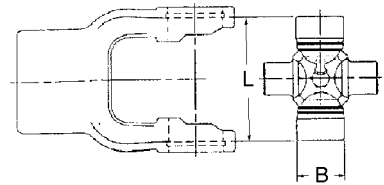

### Tractor Yokes: Pin Type Quick Disconnect (tractor end use only)

Part No.	Bore	Length (L)		Price
		mm	inches	
NE-8-2012	1-3/8"-6 Spline	98.0	3-55/64	\$57.33
NE-8-2021	1-3/8"-21 Spline	98.0	3-55/64	63.22

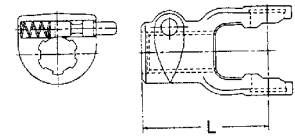

### Inner Profile Yoke

Part No.	Bore		Length (L)		Use with Tube No.	Price
	mm	inches	mm	inches		
NE-8-2230	34.5	1-23/64	75.0	2-61/64	NE-70-2205	\$50.87

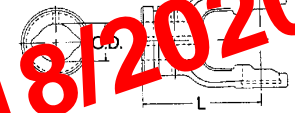

### Inner Profile Tube - 59" Length (L)

Part No.	O.D.		Wall Thickness		Use with Yoke No.	Price
	mm	inches	mm	inches		
NE-70-2205	34.5	1-23/64	3.95	5/32	NE-8-2230	\$82.65



### Outer Profile Yoke

Part No.	Bore		Length (L)		Use with Tube No.	Price
	mm	inches	mm	inches		
NE-8-2220	41.25	1-5/8	75.0	2-61/64	NE-70-2204	\$49.55

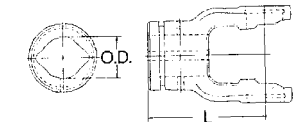

### Outer Profile Tube - 59" Length (L)

Part No.	O.D.		Wall Thickness		Use with Yoke No.	Price
	mm	inches	mm	inches		
NE-70-2204	41.25	1-5/8	2.85	7/64	NE-8-2220	\$71.08



### Tube Pin (Fits both inner and outer profile yokes)

Part No.	Diameter		Length (L)		Price
	mm	inches	mm	inches	
NE-50-2212	10.0	13/32	60.0	2-23/64	\$35.70

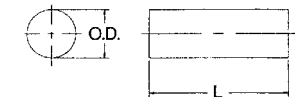

### Implement Yokes

Part No.	Bore		Length (L)		Keyway	Hole Size	Price
	mm	inches	mm	inches			
NE-8-2008	25.4	1	80.0	3-5/32	1/4"	3/8"-16	\$64.20
NE-8-2010	31.75	1-1/4	80.0	3-5/32	1/4"	3/8"-16	55.72

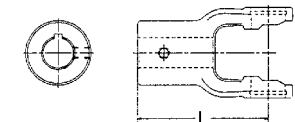

### World Shield - Plastic

Part No.	Overall Length	Bell O.D.	Price
NE-69-1248	51"	6-1/8"	\$71.31

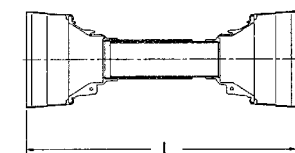

### Shield Bearing Set (2 per box)

Part No.	Bearing I.D.	Bearing Width	Use With Shield No.	Price
NE-56-2223	2"	5/32"	NE-69-1248	\$17.33

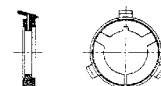

NEW PRICES AS OF 4/18/2020



# I Series - Neapco Metric Series - Walterscheid Style

## Cross & Bearing Kit: Outside Lock-Up

Part No.	Bearing Diameter (B)		Overall length (L)		Price
	mm	inches	mm	inches	
NE-1-0321	27.0	1-1/16	70.0	2-3/4	\$35.68

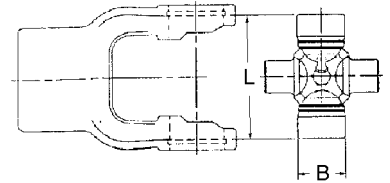

## Tractor Yokes: Pin Type Quick Disconnect (tractor end use only)

Part No.	Bore	Length (L)		Price
		mm	inches	
NE-8-3012	1-3/8"-6 Spline	104.0	4-3/32	\$58.98
NE-8-3021	1-3/8"-21 Spline	95.0	3-3/4	68.97

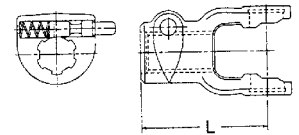

## Inner Profile Yoke

Part No.	Bore		Length (L)		Use with Tube No.	Price
	mm	inches	mm	inches		
NE-8-0130	34.5	1-23/64	80.0	3-5/32	NE-70-2205	\$63.04

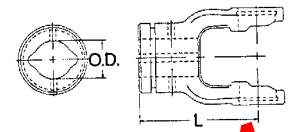

## Inner Profile Tube - 59" Length (L)

Part No.	O.D.		Wall Thickness		Use with Yoke No.	Price
	mm	inches	mm	inches		
NE-70-2205	34.5	1-23/64	3.95	5/32	NE-8-0130	\$82.65



## Outer Profile Yoke

Part No.	Bore		Length (L)		Use with Tube No.	Price
	mm	inches	mm	inches		
NE-8-0120	41.25	1-5/8	80.0	3-5/32	NE-70-2204	\$63.04

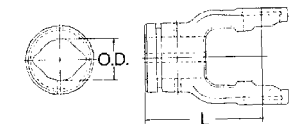

## Outer Profile Tube - 59" Length (L)

Part No.	O.D.		Wall Thickness		Use with Yoke No.	Price
	mm	inches	mm	inches		
NE-70-2204	41.25	1-5/8	2.85	7/64	NE-8-0120	\$71.08



## Tube Pin (Fits both inner and outer profile yokes)

Part No.	Diameter		Length (L)		Price
	mm	inches	mm	inches	
NE-50-2312	10.0	13/32	65.0	2-9/16	\$37.06

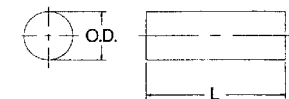

## Implement Yokes

Part No.	Bore		Length (L)		Keyway	Hole Size	Price
	mm	inches	mm	inches			
NE-8-3011	25.4	1	92.0	3-5/8	1/4"	3/8"-16	\$60.23
NE-8-3010	31.75	1-1/4	92.0	3-5/8	1/4"	3/8"-16	58.98
NE-8-3016	35.0	1-3/8	92.0	3.58		3/8" D.T.	131.82

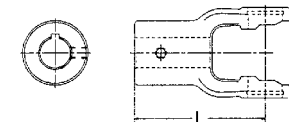

## World Shield - Plastic

Part No.	Overall Length	Bell O.D.	Price
NE-69-1248	51"	6-1/8"	\$71.31

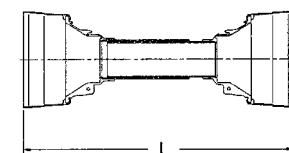

## Shield Bearing Set (2 per box)

Part No.	Bearing I.D.	Bearing Width	Use With Shield No.	Price
NE-56-2223	2"	5/32"	NE-69-1248	\$17.33

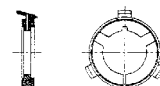

# 2300 Series - Neapco Metric Series - Walterscheid Style

### Cross & Bearing Kit: Outside Lock-Up

Part No.	Bearing Diameter (B)		Overall length (L)		Price
	mm	inches	mm	inches	
NE-1-0421	27.0	1-1/16	74.6	2-15/16	\$34.38

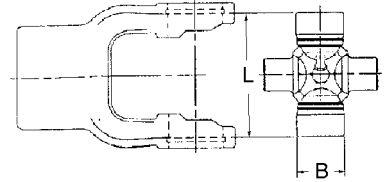

### Tractor Yokes: Pin Type Quick Disconnect (tractor end use only)

Part No.	Bore	Length (L)		Price
		mm	inches	
NE-8-4012	1-3/8"-6 Spline	107.0	4-7/32	\$64.00
NE-8-4021	1-3/8"-21 Spline	107.0	4-7/32	80.86

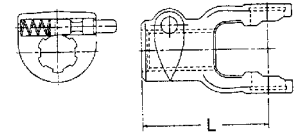

### Inner Profile Yoke

Part No.	Bore		Length (L)		Use with Tube No.	Price
	mm	inches	mm	inches		
NE-8-2330	34.5	1-23/64	85.0	3-11/32	NE-70-2205	\$60.48

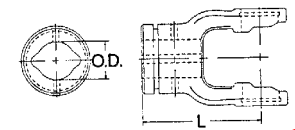

### Inner Profile Tube - 59" Length (L)

Part No.	O.D.		Wall Thickness		Use with Yoke No.	Price
	mm	inches	mm	inches		
NE-70-2205	34.5	1-23/64	3.95	5/32	NE-8-2330	\$82.65



### Outer Profile Yoke

Part No.	Bore		Length (L)		Use with Tube No.	Price
	mm	inches	mm	inches		
NE-8-2320	41.25	1-5/8	85.0	3-11/32	NE-70-2204	\$63.79

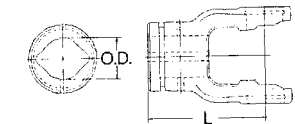

### Outer Profile Tube - 59" Length (L)

Part No.	O.D.		Wall Thickness		Use with Yoke No.	Price
	mm	inches	mm	inches		
NE-70-2204	41.25	1-5/8	2.85	7/64	NE-8-2320	\$71.08



### Tube Pin (Fits both inner and outer profile yokes)

Part No.	Diameter		Length (L)		Price
	mm	inches	mm	inches	
NE-50-2312	10.0	13/32	65.0	2-9/16	\$37.06

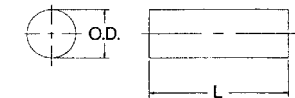

### Implement Yokes

Part No.	Bore		Length (L)		Hole Keyway	Hole Size	Price
	mm	inches	mm	inches			
NE-8-4010	31.75	1-1/4	95.0	3-3/4	1/4"	3/8"-16	\$65.23
NE-8-4011	34.93	1-3/8	95.0	3-3/4	5/16"	3/8"-16	66.61
NE-8-4016	34.93	1-3/8	89.5	3-17/32		3/8" D.T.	96.54

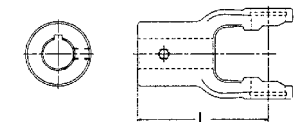

### World Shield - Plastic

Part No.	Overall Length	Bell O.D.	Price
NE-69-1248	51"	6-1/8"	\$71.31

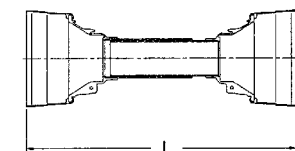

### Shield Bearing Set (2 per box)

Part No.	Bearing I.D.	Bearing Width	Use With Shield No.	Price
NE-56-2223	2"	5/32"	NE-69-1248	\$17.33



NEW PRICES AS OF 5/31/2021

# 2400 Series - Neapco Metric Series - Walterscheid Style

### Cross & Bearing Kit: Outside Lock-Up

Part No.	Bearing Diameter (B)		Overall length (L)		Price
	mm	inches	mm	inches	
NE-2-2421	32.0	1-17/64	76.0	3	\$58.98

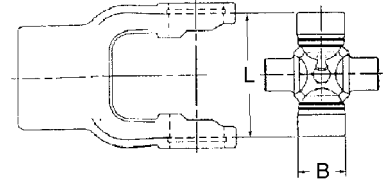

### Tractor Yokes: Pin Type Quick Disconnect (tractor end use only)

Part No.	Bore	Length (L)		Price
		mm	inches	
NE-8-2412	1-3/8"-6 Spline	112.0	4-13/32	\$101.93
NE-8-2421	1-3/8"-21 Spline	112.0	4-13/32	108.28

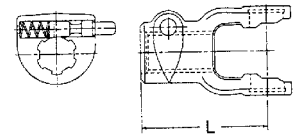

### Inner Profile Yoke

Part No.	Bore		Length (L)		Use with Tube No.	Price
	mm	inches	mm	inches		
NE-8-2430	39.5	1-9/16	92.0	3-5/8	NE-70-2405	\$97.94

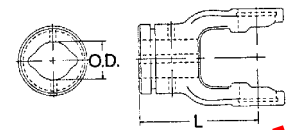

### Inner Profile Tube - 59" Length (L)

Part No.	O.D.		Wall Thickness		Use with Yoke No.	Price
	mm	inches	mm	inches		
NE-70-2405	39.5	1-9/16	4.5	11/64	NE-8-2430	\$106.05



### Outer Profile Yoke

Part No.	Bore		Length (L)		Use with Tube No.	Price
	mm	inches	mm	inches		
NE-8-2420	48.0	1-57/64	102.0	4-1/64	NE-70-2404	\$87.88

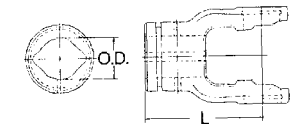

### Outer Profile Tube - 59" Length (L)

Part No.	O.D.		Wall Thickness		Use with Yoke No.	Price
	mm	inches	mm	inches		
NE-70-2404	48.0	1-57/64	3.8	5/32	NE-8-2420	\$104.96



### Tube Pin (Fits both inner and outer profile yokes)

Part No.	Diameter		Length (L)		Price
	mm	inches	mm	inches	
NE-50-0512	10.0	13/32	75.0	61/64	\$24.10

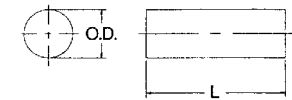

### Implement Yokes

Part No.	Bore		Length (L)		Hole Keyway	Hole Size	Price
	mm	inches	mm	inches			
NE-8-2410	31.75	1-1/4	105.0	4-1/8	1/4"	3/8"-16	\$98.82
NE-8-2411	34.93	1-3/8	105.0	4-1/8	1/2" D.T.		95.64

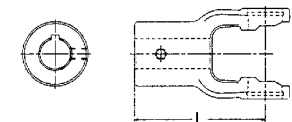

### World Shield - Plastic

Part No.	Overall Length	Bell O.D.	Price
NE-69-2248	51"	7-1/16"	\$98.40

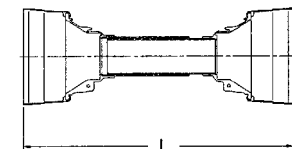

### Shield Bearing Set (2 per box)

Part No.	Bearing I.D.	Bearing Width	Use With Shield No.	Price
NE-56-2324	2-1/2"	3/16"	NE-69-2248	\$17.83

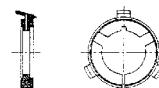

NEW PRICES AS OF 5/31/2021

# 2500 Series - Neapco Metric Series - Walterscheid Style

### Cross & Bearing Kit: Outside Lock-Up

Part No.	Bearing Diameter (B)		Overall length (L)		Price
	mm	inches	mm	inches	
NE-3-2521	36.0	1.417	89.0	3-1/2	\$61.01

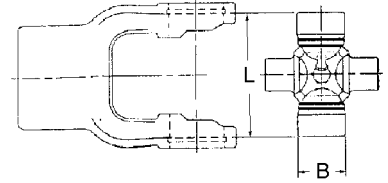

### Tractor Yokes: Pin Type Quick Disconnect (tractor end use only)

Part No.	Bore	Length (L)	Length (L)		Price
			mm	inches	
NE-8-2512	1-3/8"-6 Spline	118.0	4-5/8		\$103.77
NE-8-2521	1-3/8"-21 Spline	118.0	4-5/8		138.30
NE-8-2514	1-3/4"-20 Spline	118.0	4-5/8		147.53

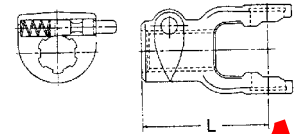

### Inner Profile Yoke

Part No.	Bore		Length (L)		Use with Tube No.	Price
	mm	inches	mm	inches		
NE-8-2530	51.0	2	106.0	4-5/32	NE-70-2505	\$128.47



### Inner Profile Tube - 59" Length (L)

Part No.	O.D.		Wall Thickness		Use with Yoke No.	Price
	mm	inches	mm	inches		
NE-70-2505	51.0	2			NE-8-2530	\$328.09

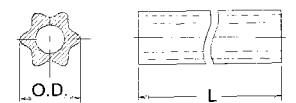

### Outer Profile Yoke

Part No.	Bore		Length (L)		Use with Tube No.	Price
	mm	inches	mm	inches		
NE-8-2520	61.0	2-13/32	112.0	4-13/32	NE-70-2504	\$136.83

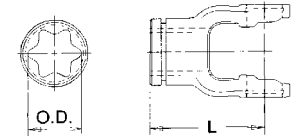

### Outer Profile Tube - 59" Length (L)

Part No.	O.D.		Wall Thickness		Use with Yoke No.	Price
	mm	inches	mm	inches		
NE-70-2504	61.0	2-13/32	4.5	11/64	NE-8-2520	\$230.78

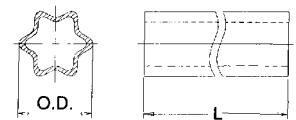

### Tube Pin (Fits both inner and outer profile yokes)

Part No.	Diameter		Length (L)		Price
	mm	inches	mm	inches	
NE-50-1090	10.0	13/32	90.0	3-1/2	\$26.63

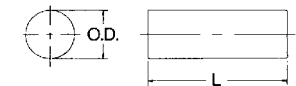

### Implement Yokes

Part No.	Bore		Length (L)		Keyway	Hole Size	Price
	mm	inches	mm	inches			
NE-8-2511	34.93	1-3/8	118.0	4-21/64	3/8"	3/8"-16.	\$179.97
NE-8-2515	38.1	1-1/2	118.0	4-21/64	3/8"	3/8"-16.	181.75

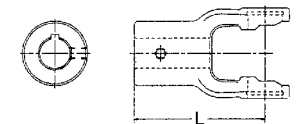

### Shear Pin Yokes

Part No.	Bore		Length (L)		Drill Thru	Price
	mm	inches	mm	inches		
NE-8-2535	38.1	1-1/2	118.0	4-41/64	1/2" D.T.	\$181.77

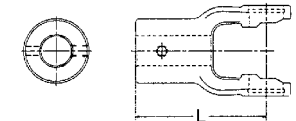

### World Shield - Plastic

Part No.	Overall Length	Bell O.D.	Price
NE-69-2248	51"	7-1/16"	\$98.40

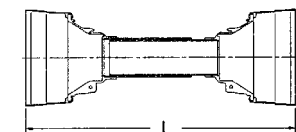

### Shield Bearing Set (2 per box)

Part No.	Bearing I.D.	Bearing Width	Use With Shield No.	Price
NE-56-2324	2-1/2"	3/16"	NE-69-2248	\$17.83

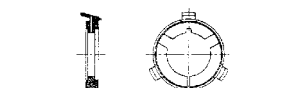

NEW PRICES AS OF 5/31/2021

# G & G

## PTO REPAIR AND REPLACEMENT CENTER

6N Series	12N Series	14N Series	35N Series	Brg. & S/H Kits
134-1214 -----2	134-1618 -----2	140-1400 -----1	136-1900 -----1	128-0600 -----4
138-1214 -----2	138-1618 -----2	177-1400 -----2	140-3500 -----1	128-1200 -----8
177-0600 -----2	177-1200 -----2	181-1400 -----2	177-3500 -----1	02010300 -----4
180-0600 -----2	180-1200 -----2	18231406 -----4	181-3500 -----1	02010306 -----10
18230606 -----4	18231206 -----4	18231421 -----2	18233506 -----3	02010321 -----2
18230621 -----1	18231221 -----1	184-1416 -----2	18233521 -----1	02010495 -----4
184-0612 -----1	184-1216 -----4	184-1418 -----2	184-3518 -----1	
184-0614 -----1	184-1218 -----2	184-1420 -----2	184-3520 -----2	
184-0615 -----1	184-1220 -----2	184-1422 -----2	184-3522 -----2	
184-0616 -----4	184-1222 -----1	184-1423 -----2	184-3523 -----1	
184-0618 -----2	186-1200 -----1	185-1400 -----1	184-3524 -----2	
184-0620 -----2	188-1200 -----1	188-1400 -----1	185-3500 -----1	
186-0600 -----1	302-1200 -----10	194-1400 -----2	188-3500 -----1	
188-0600 -----1	303-1248 -----1	302-1400 -----10	194-3500 -----2	
302-0600 -----6		303-1248 -----1	302-3500 -----6	
303-0648 -----1			303-3548 -----1	

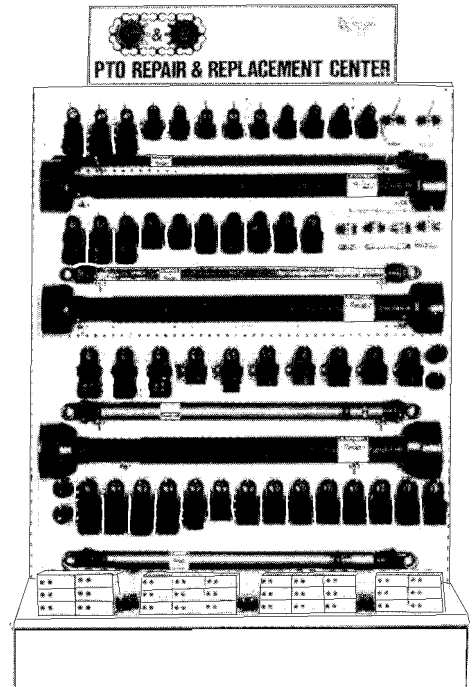

**ORDER NO. 002-0155**

Display includes items to cover most repair and replacement needs for 6N, 12N, 14N, and 35N U-Joints and PTO shafts, with 48" x 66" display rack with hooks. Assortment of tubing and shafting in 5' lengths not shown in photo. We suggest the tubing and shafting not be stored on display rack. Approx. Weight 500 lbs.

002-0155.....PTO Display..... \$6308.02

Dealer Schedule.....203

# G & G

## PTO REPAIR AND REPLACEMENT CENTER

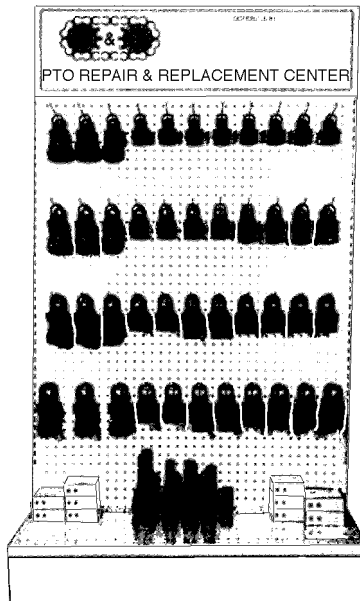

6N Series	12N Series	14N Series	35N Series
177-0600 -----2	177-1200 -----2	177-1400 -----2	177-3500 -----2
180-0600 -----2	180-1200 -----2	181-1400 -----2	181-3500 -----2
18230606 -----2	18231206 -----2	18231406 -----2	18233506 -----2
18230621 -----1	18231221 -----1	18231421 -----1	18233521 -----1
184-0616 -----2	184-1216 -----2	184-1418 -----1	184-3520 -----1
184-0618 -----1	184-1218 -----1	184-1420 -----2	184-3522 -----1
184-0620 -----1	184-1220 -----1	184-1422 -----1	184-3524 -----2
302-0600 -----4	302-1200 -----6	302-1400 -----6	302-3500 -----4

**STOCK NO. 002-150**

Display includes popular yokes for 6N, 12N, 14N, and 35N U-Joints. Repair kits and splined adapters with 36" x 54" display rack with hooks. Approx. Weight 180 lbs.

002-0150.....PTO Display..... \$2706.70

Dealer Schedule.....203

**Call Toll-Free 1-800-444-8666**

**SEAMLESS SQUARE - RECTANGULAR TUBING & SHAFTING**  
SOLD IN 5/6 OR 10/12 FT. LENGTHS

**TUBING & SHAFTING**

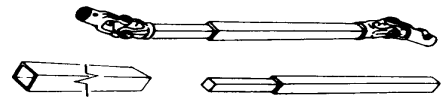
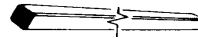
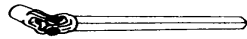

**SQUARE TUBING**

6 ft. No.	12 ft. No.	Wall	O.D.	Telescope	Per ft
132-1200	133-1200	1/8	1	3/4	\$23.13
132-1400	133-1400	1/8	1-1/8	7/8	17.25
132-1500	133-1500	1/8	1-3/16	15/16	18.34
132-1600	133-1600	1/8	1-1/4	1	18.77
132-1601	133-1601	3/16	1-3/8	1	30.41
132-1800	133-1800	1/8	1-3/8	1-1/8	20.31
132-1900	133-1900	5/32	1-1/2	1-3/16	30.97
132-2000	133-2000	3/16	1-5/8	1-1/4	34.00
132-2100	133-2100	7/32	1-3/4	1-5/16	40.66
132-2200	133-2200	3/16	1-3/4	1-3/8	38.43
132-2400	133-2400	3/16	1-7/8	1-1/2	41.22

MATERIAL: 1010/1020 Power Take Off Tubing.

**SQUARE SHAFTING**

6 ft. No.	12 ft. No.	Size	Per ft.
136-1200	137-1200	3/4	\$10.79
136-1400	137-1400	7/8	14.30
136-1500	137-1500	15/16	16.48
136-1600	137-1600	1	18.77
136-1800	137-1800	1-1/8	23.67
136-1900	137-1900	1-3/16	26.47
136-2000	137-2000	1-1/4	29.04
136-2100	137-2100	1-5/16	32.10
136-2200	137-2200	1-3/8	35.20
136-2400	137-2400	1-1/2	41.73

MATERIAL: 1045 Cold Drawn.

**RECTANGULAR TUBING**

6 ft. No.	12 ft. No.	Wall	O.D.	Telescope	Per ft
134-1214	135-1214	1/8	1x1-1/8	3/4x7/8	\$18.53
134-1618	135-1618	1/8	1-1/4x1-3/8	1x1-1/8	25.23

MATERIAL: Mandrel Drawn PTO Tubing.

**RECTANGULAR SHAFTING**

6 ft. No.	12 ft. No.	Size	Per ft.
138-1214	139-1214	3/4 x 7/8	\$13.61
138-1618	139-1618	1 x 1-1/8	22.77

MATERIAL: 1045 Cold Drawn.



**ROUND REPAIR TUBING**

Seamless Mechanical Tubing.  
MATERIAL: Cold Drawn Buttweld.



**1/8 INCH WALL**

5 ft. No	10 ft. No	O.D.	I.D.	Per ft.
13021006*		5/8	3/8	\$10.10
13021208	13121208	3/4	1/2	10.76
13021410	13121410	7/8	5/8	11.32
13021612	13121612	1	3/4	13.40
13021814	13121814	1-1/8	7/8	13.59
13022016	13122016	1-1/4	1	13.78
13022218	13122218	1-3/8	1-1/8	16.26
13022420	13122420	1-1/2	1-1/4	17.40
13022622	13122622	1-5/8	1-3/8	20.87
13022824	13122824	1-3/4	1-1/2	21.87
13023026	13123026	1-7/8	1-5/8	24.20
13023228	13123228	2	1-3/4	25.85
13023430	13123430	2-1/8	1-7/8	26.94
13023632	13123632	2-1/4	2	28.25
13023834*		2-3/8	2-1/8	21.50
13024036	13124036	2-1/2	2-1/4	38.20
13024440	13124440	2-3/4	2-1/2	53.46
13024642*		2-7/8	2-5/8	25.30
13024844*		3	2-3/4	43.34

**3/16 INCH WALL**

13031408*		7/8"	1/2"	12.56
13031610*		1"	5/8"	13.37
13031812*		1-1/8"	3/4"	20.21
13032216*		1-3/8"	1"	20.21

**1/4 INCH WALL**

13041608	13141608	1	1/2	\$24.93
13041810	13141810	1-1/8	5/8	25.51
13042012	13142012	1-1/4	3/4	25.72
13042214	13142214	1-3/8	7/8	29.98

**1/4 INCH WALL (Continued)**

5 ft. No	10 ft. No	O.D.	I.D.	Per ft.
13042416	13142416	1-1/2	1	\$30.67
13042618	13142618	1-5/8	1-1/8	39.08
13042820	13142820	1-3/4	1-1/4	42.24
13043022	13143022	1-7/8	1-3/8	46.18
13043224	13143224	2	1-1/2	46.18
13043426	13143426	2-1/8	1-5/8	50.31
13043628	13143628	2-1/4	1-3/4	64.78
13043830	13143830	2-3/8	1-7/8	69.31
13044032	13144032	2-1/2	2	73.57
13044234		2-5/8	2-1/8	70.55
13044436	13144436	2-3/4	2-1/4	83.46
13044840	13144840	3	2-1/2	142.93

**3/8 INCH WALL**

13062412**		1-1/2	3/4	36.10
13062816**		1-3/4	1"	36.67
13063018**		1-7/8	1-1/8"	38.80
13063220**		2"	1-1/4"	40.76
13063422**		2-1/8"	1-3/8"	43.88
13063624**		2-1/4"	1-1/2"	46.51
13063826**		2-3/8"	1-5/8"	49.30
13064028**		2-1/2"	1-3/4"	50.39
13064230**		2-5/8"	1-7/8"	53.22
13064432**		2-3/4"	2"	59.25
13064836**		3"	2-1/4"	65.50

**7/16 INCH WALL**

13072410**		1-1/2"	5/8"	39.10
------------	--	--------	------	-------

**1/2 INCH WALL**

13083216**		2"	1"	48.33
13083620**		2-1/4"	1-1/4"	68.85
13084024**		2-1/2"	1-1/2"	74.70
13084832**		3"	2"	76.60
13085640**		3-1/2"	2-1/2"	101.60

**5/8 INCH WALL**

13104828**		3"	1-3/4"	81.84
------------	--	----	--------	-------

\* - (WILL NOT TELESCOPE) Specify 5 ft. or 10 ft. Lengths.  
\*\* - (WILL NOT TELESCOPE) Specify 2-1/2 ft., 5 ft. or 10 ft. Lengths.

**NOTE:** 10 & 12 ft. lengths CAN NOT be shipped by U.P.S.

DEALER SCHEDULE THIS PAGE.....203

Call for price and availability of sizes not listed.

**METAL PTO SAFETY SHIELDS**

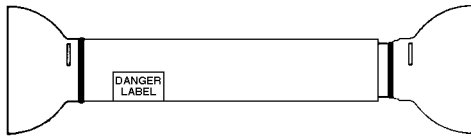

**COMPLETE SET OF SHIELDS INCLUDES BOTH INNER & OUTER SHIELDS.**

Complete with bells for Dim. L 48" or 72" PTO Shafts. Sold in set only. For shorter length PTO simply cut shields to length.

Order No.	Series	Dim. L	Weight	Each
301-0648	6N	48"	11.71	\$115.41
301-1248	12N-14N	48"	13.12	130.80
301-3548	35N	48"	14.17	203.02
301-4448	44R-55N	48"	16.43	294.89
301-0672	6N	72"	18.37	170.13
301-1272	12N-14N	72"	21.55	194.35
301-3572	35N	72"	22.52	254.45

Dealer Schedule.....203

**PLASTIC PTO SAFETY SHIELDS**

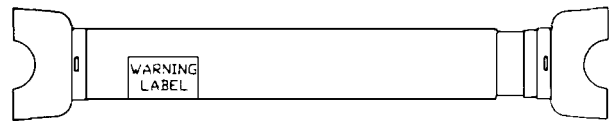

**COMPLETE SET OF SHIELDS INCLUDES BOTH INNER & OUTER SHIELDS WITH NOTCHES.**

Complete with bells for Dim. L 48" PTO Shafts. For shorter length PTO simply cut shields to length.

Order No.	Series	Dim. L	Weight	Each
300-0648	6N	48"	2.00	\$67.69
300-1248	12N-14N	48"	2.20	82.71
300-3548	35N	48"	2.55	93.86
300-4448	44R-55N	48"	3.40	159.69

Dealer Schedule Complete Shields.....203

**Outer PTO Shield Half Only**

300O0648	6N	48"	1.24	35.25
300O1248	12N-14N	48"	1.39	44.19
300O3548	35N	48"	1.51	50.14
300O4448	44R-55N	48"	2.09	82.43

**Inner PTO Shield Half Only**

300I0648	6N	48"	1.14	32.94
300I1248	12N-14N	48"	1.17	38.52
300I3548	35N	48"	1.28	44.00
300I4448	44R-55N	48"	1.90	77.40

Dealer Schedule Shield Halves.....102

**BEARING SHIELD KIT**

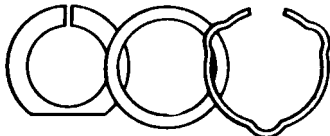

Each kit contains nylon bearing, thrust washer and snap ring

Order No.	Fits PTO Series	Price
128-0600	6N	\$4.64
128-1200	12N 14N 35N	5.50
128-5500	44R 55N	10.29

Dealer Schedule.....203

**HEXAGON SHAFTING**

Material: 1045 Cold Drawn.

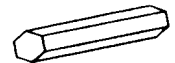

6 ft. No.	12 ft. No.	O.D.	Per ft.
142-0900	143-0900	9/16	\$10.90
142-1000	143-1000	5/8	14.08
142-1200	143-1200	3/4	16.85
142-1400	143-1400	7/8	18.85
142-1600	143-1600	1	24.39
142-1800	143-1800	1-1/8	32.26
142-2000	143-2000	1-1/4	37.76
142-2400	143-2400	1-1/2	44.97
142-2800	143-2800	1-3/4	61.39

Dealer Schedule.....203

**KEYED SHAFTING**

Available in 3' & 6' lengths



Material: C1018 Drawn

3' No.	6' No.	O.D.	Keyway	Wt. Per Ft.	Price Per Ft.
144-0800	145-0800	1/2"	1/8 x 1/16	0.67	\$9.44
144-1000	145-1000	5/8"	3/16 x 3/32	1.04	10.44
144-1100	145-1100	11/16"	3/16 x 3/32	1.26	11.86
144-1200	145-1200	3/4"	3/16 x 3/32	1.50	12.01
144-1300	145-1300	13/16"	3/16 x 3/32	1.76	17.89
144-1400	145-1400	7/8"	3/16 x 3/32	2.04	13.52
144-1600	145-1600	1"	1/4 x 1/8	2.67	14.96
144-1800	145-1800	1-1/8"	1/4 x 1/8	3.38	16.80
144-1900	145-1900	1-3/16"	1/4 x 1/8	3.77	18.24
144-2000	145-2000	1-1/4"	1/4 x 1/8	4.17	19.50
144-2005	145-2005	1-1/4"	5/16" x 5/32	4.17	24.84
144-2100	145-2100	1-5/16"	5/16 x 5/32	4.60	20.82
144-2200	145-2200	1-3/8"	5/16 x 5/32	5.05	22.56
144-2300	145-2300	1-7/16"	3/8 x 3/16	5.52	24.38
144-2400	145-2400	1-1/2"	3/8 x 3/16	5.89	25.96
144-2800	145-2800	1-3/4"	3/8 x 3/16	8.18	32.86

Dealer Schedule.....152

**PTO TORQUE TUBING**

MATERIAL: Hot Rolled Electric Welded.

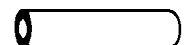

6 ft. No.	12 ft. No.	Series	O.D.	I.D.	Per ft.
140-0600	141-0600	6N	1-5/8	1-15/32	\$48.44
140-1400	141-1400	14N	2	1-13/16	24.17
140-3500	141-3500	35N	2-1/8	1-7/8	39.42
NE-70-2250		35N	2-1/4	2-1/64	26.79
140-4400	141-4400	44R-55N	2-1/2	2-15/64	61.17

Dealer Schedule.....203

NEW PRICES AS OF 12/4/2018





# G & G SNAP HITCH PIN KITS

EACH KIT CONTAINS A NEW SPRING AND TRAILING SNAP HITCH PIN. ORDER BY STOCK NUMBER.

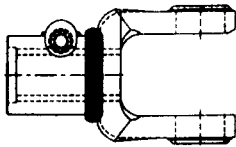

## WELDED YOKE

6N, 12N, 14N, 35N, 44R

Fits 1-3/8 x 6 Spline Yokes or Spline Adapters. STOCK NO. 02010306  
 Fits 1-3/8 x 21 Spline Yokes or Spline Adapters. STOCK NO. 02010321

APPROX. WT.  
 .13  
 .19

STOCK NO. 02010306

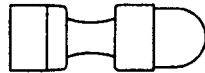

STOCK NO. 02010321



Fits 55N Series 1-3/8 x 6 Spline Yoke. STOCK NO. 02015506  
 Fits 55N Series 1-3/8 x 21 Spline Yoke. STOCK NO. 02015521  
 Fits 55N Series 1-3/4 x 20 Spline Yoke. STOCK NO. 02015520

APPROX. WT.  
 .20  
 .21  
 .20

STOCK NO. 02015506



STOCK NO. 02015521

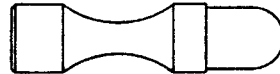

STOCK NO. 02015520



## FIELD REPLACEMENT INSTRUCTIONS FOR NEW STYLE TRAILING SNAP HITCH PIN KITS

**CAUTION:** ALWAYS WEAR EYE PROTECTION WHEN PERFORMING THIS OPERATION.

- 1) Remove the old hitch pin and spring.
- 2) Place the yoke on a hard surface with the closed end of the pin tube down on the surface.
- 3) Place spring and pin into the open end of the tube.
- 4) Using a 1/8" drift punch, nail set or similar tool and a medium size hammer, deform the end of the tube in 4 or 5 places around the hole periphery while depressing the pin with your thumb. Care should be taken as not to over-stake the pin, which may cause it to stick. Check the crimp to make sure that the pin is secured without sticking.

### NOTE:

**Snap Ring Type  
 Repair Kits Are  
 No Longer Available!**

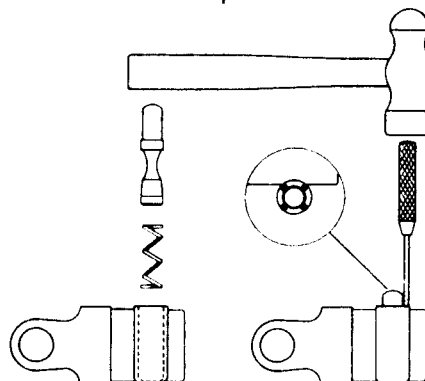

**All The Above Pin Kits**

**List: \$8.26**

Dealer Schedule.....203

NEW PRICES AS OF 12/4/2018

**READY MADE PTO SHAFTS**

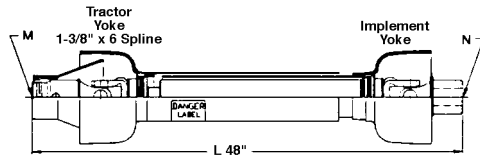

Equipped with Safety Orange Plastic Shields, Dim. M, 1-3/8 x 6 S.H., Dim. L 48 inch.

Order No.	Series	KWY & SS	Price
306-4816	6N	1" Rd.	\$318.90
306-4818	6N	1-1/8" Rd.	318.90
306-4820	6N	1-1/4" Rd.	318.90
312-4816	12N	1" Rd.	391.06
312-4818	12N	1-1/8" Rd.	391.06
312-4820	12N	1-1/4" Rd.	391.06
314-4818	14N	1-1/8" Rd.	449.55
314-4820	14N	1-1/4" Rd.	449.55
314-4822	14N	1-3/8" Rd.	449.55
314-4824	14N	1-1/2" Rd.	449.55
335-4820	35N	1-1/4" Rd.	572.47
335-4822	35N	1-3/8" Rd.	572.47
335-4824	35N	1-1/2" Rd.	572.47
344-4824	44R	1-1/2" Rd.	729.35
355-4824	55N	1-1/2" Rd.	1109.29

**READY MADE PTO SHAFTS**

LESS EQUIPMENT END YOKE

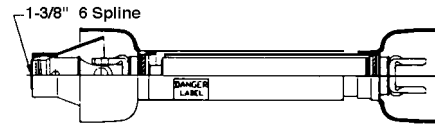

PTO Shafts furnished without center cross and end yoke on equipment end. Order center cross and end yoke as required. When center cross and end yoke are installed the overall length of PTO will be 48 inches. Standard Plastic Shields are furnished.

Order No.	U-Joint Series	Price
305-0648	6N	\$295.54
305-1248	12N	358.15
305-1448	14N	440.97
305-3548	35N	521.00
305-4448	44R	627.66
305-5548	55N	928.55

**YOKE & BAR ASSEMBLIES**

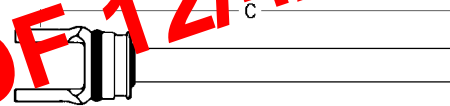

**YOKE & TUBE ASSEMBLIES**



Order No.	Series	Tubing I.D.	C	Price
186-0600	6N	3/4 x 7/8	37-7/8	\$67.88
186-1200	12N	1 x 1-1/8	36-5/8	86.80

Order No.	Series	Shaft Size	C	Price
188-0600	6N	3/4 x 7/8	39-3/8	\$57.10
188-1200	12N	1 x 1-1/8	38-1/16	85.24
188-1400	14N	1 x 1-1/8	35-3/8	95.70
188-3500	35N	1-3/16 Sq.	33-1/8	113.89
188-4400	44R	1-5/16 Sq.	32-9/16	168.97

**YOKE & TUBE ASSEMBLIES WITH SLIP SLEEVE**

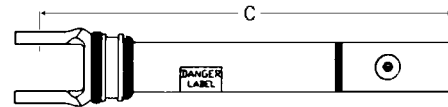

Order No.	Series	Tube Size	Slip Sleeve	C	Price
185-1400	14N	2 x 1-13/16	1 x 1-1/8	36-3/16	\$106.02
185-3500	35N	2-1/8 x 1-7/8	1-3/16 Sq.	34-1/4	158.30
185-4400	44R	2-1/2 x 2-15/16	1-5/16 Sq.	33-7/8	215.43

**BALL TYPE SNAP HITCH REPAIR KIT**

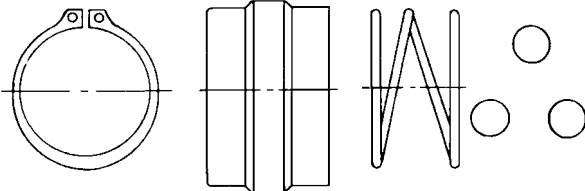

Fits 1-3/8" x 6 or 21 Spline Snap Hitch, Also Half Yokes, and Spline Adapters, Repair Kit includes: a coiled spring, three ball bearings, a retaining shell, and snap ring.

Order No.	Each
02010300	Snap Hitch Repair Kit ..... \$12.58

**Centralize with Central**  
**Call 1-800-444-8666**

# YOKES

## ROUND BORE YOKE FURNISHED W/STD. KW & SS

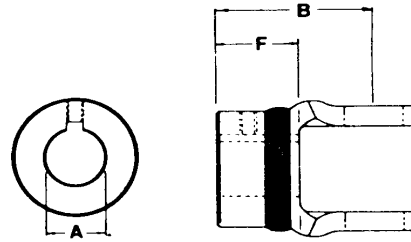

Order No.	Series	A	B	F	Price
184-0410	4P	5/8	2-3/8	1-1/4	\$18.36
184-0412	4P	3/4	2-3/8	1-1/4	18.36
184-0414	4P	7/8	2-3/8	1-1/4	18.36
184-0416	4P	1	2-3/8	1-1/4	18.36
184-0512	0675	3/4	2-1/2	1	22.18
184-0514*	0675	7/8	2-1/2	1	27.00
184-0516	0675	1	2-1/2	1	22.18
184-0518	0675	1-1/8	2-1/2	1	27.48
184-0520**	0675	1-1/4	2-1/2	1	25.68
184-0521	0675	1-1/4	2-1/2	1	25.68
184-0610	6N	5/8	2-1/2	1-1/8	21.70
184-0612	6N	3/4	2-1/2	1-1/8	21.70
184-0614	6N	7/8	2-1/2	1-1/8	21.70
184-0615	6N	15/16	2-1/2	1-1/8	21.70
184-0616	6N	1	2-1/2	1-1/8	21.70
184-0618	6N	1-1/8	2-1/2	1-1/8	27.50
184-0620	6N	1-1/4	2-1/2	1-1/8	27.50
184-1216	12N	1	3-1/2	2	35.67
184-1218	12N	1-1/8	3-1/2	2	35.67
184-1220	12N	1-1/4	3-1/2	2	36.06
18451220**	12N	1-1/4	3-1/2	2	39.50
184-1222	12N	1-3/8	3-1/2	2	35.06

Order No.	Series	A	B	F	Price
184-1416	14N	1	3-1/2	1-3/4	\$36.38
184-1418	14N	1-1/8	3-1/2	1-3/4	36.38
184-1420	14N	1-1/4	3-1/2	1-3/4	36.38
18451420**	14N	1-1/4	3-1/2	1-3/4	39.50
184-1422	14N	1-3/8	3-1/2	1-3/4	38.63
184-1423	14N	1-7/16	3-1/2	1-3/4	38.63
184-1424	14N	1-1/2	3-1/2	1-3/4	38.63
184-3516	35N	1	4-5/32	2-3/16	53.97
184-3518	35N	1-1/8	4-5/32	2-3/16	53.97
184-3520	35N	1-1/4	4-5/32	2-3/16	53.97
184-3522	35N	1-3/8	4-5/32	2-3/16	53.97
184-3523	35N	1-7/16	4-5/32	2-3/16	53.97
184-3524	35N	1-1/2	4-5/32	2-3/16	53.97
184-3528	35N	1-3/4	4-5/32	2-3/16	65.23
184-4422	44R	1-3/8	4-7/32	1-11/16	84.14
184-4424	44R	1-1/2	4-7/32	1-11/16	84.14
184-4428	44R	1-3/4	4-7/32	1-11/16	84.14
184-5516	55N	1	5-9/16	2-7/8	174.92
184-5524	55N	1-1/2	5-9/16	2-7/8	174.92
184-5528	55N	1-3/4	5-9/16	2-7/8	174.92
184-5532	55N	2	5-9/16	2-7/8	231.93

\*Keyway 1/4". \*\*Keyway 5/16".

## YOKE IDENTIFICATION HORSE POWER RATING CHART

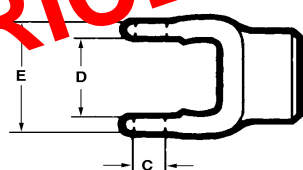

Series No.	C	D	E	HP @ RPM
K1C**				3
4P**	7/8			5
0675*	15/16	1-31/64		12
6N*	31/32	1-7/16		12
12N*	1-1/16	1-13/16		28
14N*	1-1/8		2-29/32	36
35N*	1-1/4		3-31/64	65
44R*	1-5/16	2-51/64		90
55N	1-17/32		4-5/8	110

\*Needle Bearing Type. \*\*Plain Bearing Type.  
Note - - All have a maximum operating angle of 15 degrees.

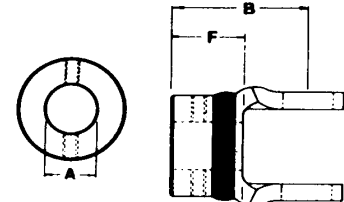

## SHEAR PIN YOKE

Order No.	Series	A	B	F	Hole	Price
196-0616	6N	1	2-1/2	1-7/64	1/4	\$33.00
196-0618	6N	1-1/8	2-1/2	1-7/64	1/4	33.00
196-0620	6N	1-1/4	2-1/2	1-7/64	1/4	33.00
196-1216	12N	1	3-1/2	1-29/32	1/4	43.19
196-1218	12N	1-1/8	3-1/2	1-29/32	1/4	43.19
196-1220	12N	1-1/4	3-1/2	1-29/32	1/4	43.85
196-1222	12N	1-3/8	3-1/2	1-29/32	1/4	43.85
196-1418	14N	1-1/8	3-1/2	1-41/64	1/4	44.66
196-1420	14N	1-1/4	3-1/2	1-41/64	1/4	44.66
196-1422	14N	1-3/8	3-1/2	1-41/64	1/4	46.89
196-1424	14N	1-1/2	3-1/2	1-41/64	1/4	46.89
196-3520	35N	1-1/4	4-1/8	2-9/64	1/4	62.21
196-3522	35N	1-3/8	4-1/8	2-9/64	1/4	62.21
196-3524	35N	1-1/2	4-1/8	2-9/64	1/4	62.21

Order No.	Series	A Bore	B O.D.	C Step O.D.	D Step Width	E O.L.	Price
194-0600	6N	3/4 x 7/8	1-1/2	1-15/32	1	5	\$38.67
194-0615	6N	1" x 15 Spline	1-1/2	1-15/32	1/2	3	36.87
194-1400	12N, 14N	1 x 1-1/8	2	1-13/16	3/4	5	40.66
194-3500*	35N	1-3/16 Sq.	2-1/8	1-7/8	3/4	5	42.01
194-4400*	44R	1-5/16 Sq.	2-1/2	2-15/64	1	5	45.99
194-5500*	55N	1-3/8 Sq.	2-1/2	2-15/64	1	5	65.85

\*Slip Sleeve Hardened.

## SLIP SLEEVES

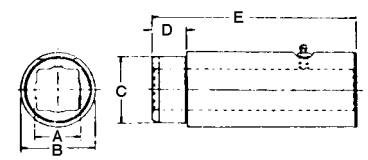

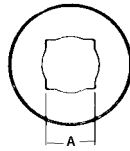
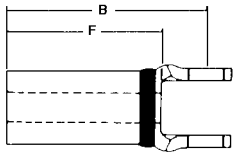

### SLIP SLEEVE YOKE



FURNISHED WITH GREASE ZERK

Order No.	Series	A	B	F	Price
19100414	4P	7/8 Square	5-1/16	3-15/16	\$31.97
191-0614	6N	7/8 Round with 1/4" KW	5-3/8	4-	63.88
191-0616	6N	1 Round with 1/4" KW	5-3/8	4-	86.78
19100612	6N	3/4 Square	5-3/8	4-	31.97
19100614	6N	7/8 Square	5-3/8	4-	31.97
19100616	6N	3/4 x 7/8 Rect.	5-3/8	4-	31.97

Order No.	Series	A	B	Dia.	Price
195-0606	6N	1-3/8 x 6	4-23/32	1/4	\$129.51
195-1206	12N	1-3/8 x 6	4-15/32	5/16	129.51
195-1406	14N	1-3/8 x 6	5-3/32	5/16	137.97
195-1421	14N	1-3/8 x 21	5-3/32	5/16	137.97
195-3506	35N	1-3/8 x 6	6-1/2	3/8	204.99
195-3521	35N	1-3/8 x 21	6-1/2	1/2	204.99
195-4406	44R	1-3/8 x 6	7-1/4	7/16	258.02
195-4421	44R	1-3/8 x 21	7-1/4	7/16	258.02
195-5506	55N	1-3/8 x 6	6-15/16	7/16	325.11
195-5521	55N	1-3/8 x 21	6-15/16	7/16	325.11

### PIN SNAP HITCH SHEAR YOKE

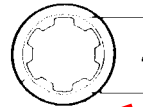
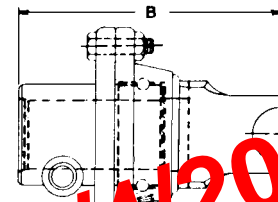
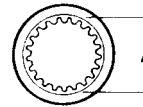

BALL BEARING TYPE

### HEX BORE YOKES

### G & G PIN SNAP HITCH YOKES

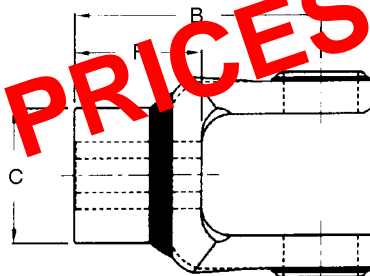

Furnished With Set Screw

Order No.	Series	A	B	C	F	Price
197-0614	6N	7/8	2-1/2	2-1/8	1-7/64	\$27.50
197-0616	6N	1	2-1/2	2-1/8	1-7/64	27.50
197-0618	6N	1-1/8	2-1/2	2-1/8	1-7/64	27.50
197-1214	12N	7/8	3-1/2	2-1/8	1-29/32	37.90
197-1216	12N	1	3-1/2	2-1/8	1-29/32	37.90
197-1218	12N	1-1/8	3-1/2	2-1/8	1-29/32	37.90
197-1416	14N	1	3-1/2	2-1/2	1-41/64	40.62
197-1418	14N	1-1/8	3-1/2	2-1/2	1-41/64	40.62
197-1420	14N	1-1/4	3-1/2	2-1/2	1-41/64	40.62
197-3518	35N	1-1/8	4-5/32	2-1/2	2-9/64	86.03
197-3520	35N	1-1/4	4-5/32	2-1/2	2-9/64	86.03

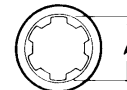
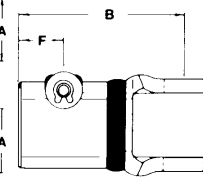
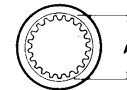

Order No.	Series	A	B	F	Price
182-0606	6N	1-3/8 x 6	4-1/64	2-5/8	\$53.54
182-0621	6N	1-3/8 x 21	4-1/64	2-5/8	53.54
182-1206	12N	1-3/8 x 6	4-7/32	2-5/8	55.00
182-1221	12N	1-3/8 x 21	4-7/32	2-5/8	55.00
182-1406	14N	1-3/8 x 6	4-7/64	2-1/4	58.23
182-1421	14N	1-3/8 x 21	4-7/64	2-1/4	58.23
182-3506	35N	1-3/8 x 6	4-57/64	2-7/8	70.36
182-3521	35N	1-3/8 x 21	4-57/64	2-7/8	70.36
182-4406	44R	1-3/8 x 6	4-15/16	2-1/2	105.49
182-4421	44R	1-3/8 x 21	4-15/16	2-1/2	105.49
182-5506	55N	1-3/8 x 6	5-13/16	3-5/8	187.31
182-5521	55N	1-3/8 x 21	5-13/16	3-5/8	187.31

See Pages 201-202 For G&G Snap Hitch Repair Kits

### Hex Bore Yokes (with Snap Hitch Pin)

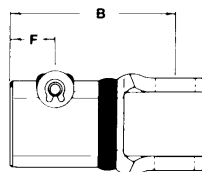
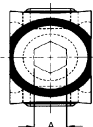

182H3518	.35N	1-1/8	4-1/2	2-1/2	2-1/2	71.03
182H3520	.35N	1-1/4	4-1/2	2-1/2	2-1/2	71.03

**Call Toll-Free  
1-800-444-8666**

**COLLAR BALL  
SNAP HITCH YOKES**



**COLLAR BALL  
SNAP HITCH SHEAR YOKE**

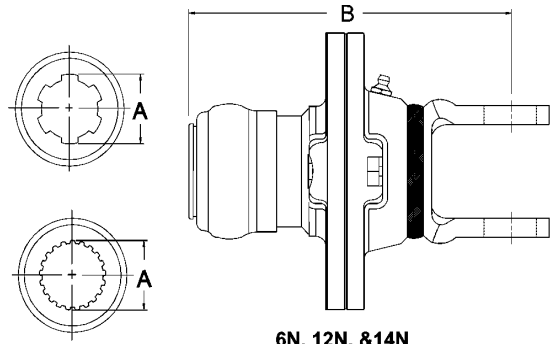
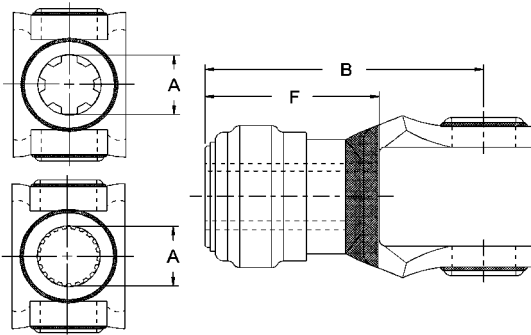

6N, 12N, & 14N

**495 STYLE**

Order No.	Series	A	B	F	Price	
18230606	6N	1-3/8"-6	4-1/2	3-7/64	\$53.54	
18230615	6N	1"-15	3-41/64	2-1/4	55.92	
18230621	6N	1-3/8"-21	4-1/2	3-7/64	53.54	
18231206	12N	1-3/8"-6	4-11/16	3-3/32	55.00	
18231215	12N	1"-15	3-27/32	2-1/4	57.95	
18231221	12N	1-3/8"-21	4-11/16	3-3/32	55.00	
18231406	14N	1-3/8"-6	4-61/64	3-3/32	58.23	
18231421	14N	1-3/8"-21	4-61/64	3-3/32	58.23	
02010300	Repair Kit f/1-3/8" 6 or 21, 6N or 12N					12.58
02011516	Repair Kit f/1"-15, 6N or 12N					15.89

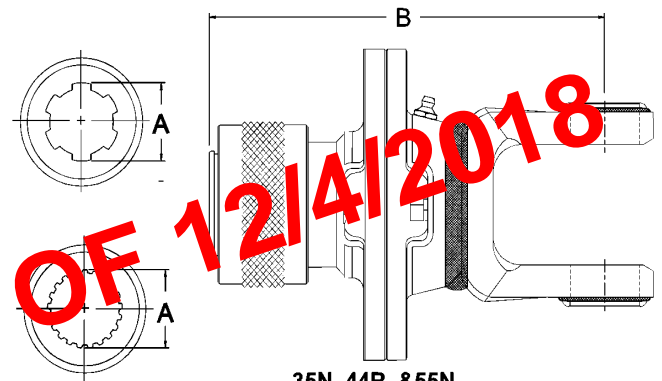

35N, 44R, & 55N

Shear Pin

Order No.	Series	A	B	Dia.	Price	
495-0606	6N	1-3/8 x 6	6-27/64	1/4	\$257.53	
495-1206	12N	1-3/8 x 6	6-5/8	5/16	223.48	
495-1406	14N	1-3/8 x 6	6-29/32	5/16	236.36	
495-1421	14N	1-3/8 x 21	6-29/32	5/16	236.36	
495-3506	35N	1-3/8 x 6	7-13/64	3/8	259.05	
495-3521	35N	1-3/8 x 21	7-13/64	3/8	259.05	
495-4406	44R	1-3/8 x 6	7-11/16	7/16	259.13	
495-4421	44R	1-3/8 x 21	7-11/16	7/16	259.13	
495-5506	55N	1-3/8 x 6	8-5/8	7/16	535.47	
495-5521	55N	1-3/8 x 21	8-5/8	7/16	535.47	
02010300	Repair Kit f/ 6N, 12N, 14N 6-Spline					12.58
02010495	Repair Kit f/ 35N, 44R, 55N 21 Spline					28.91

**NEW PRICES AS OF 12/4/2018**

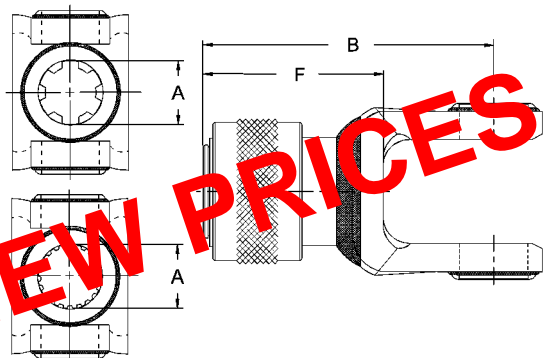

18233506	35N	1-3/8 x 6	5-19/64	3-21/64	70.36	
18233521	35N	1-3/8 x 21	5-19/64	3-21/64	70.36	
18234406	44R	1-3/8 x 6	5-13/16	3-3/8	106.49	
18234421	44R	1-3/8 x 21	5-13/16	3-3/8	106.49	
02010495	Repair Kit f/ 35N, 44R					28.91

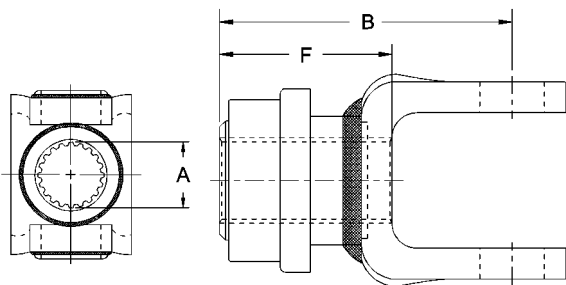

18233520	35N	1-3/4 x 20	5-3/32	2-31/32	145.95	
18234420	44R	1-3/4 x 20	5-35/64	3-5/32	196.02	
18235520	55R	1-3/4 x 20	6-25/64	3-3/4	341.83	
02010595	Repair Kit f/ 35N, 44R, 55N					55.45

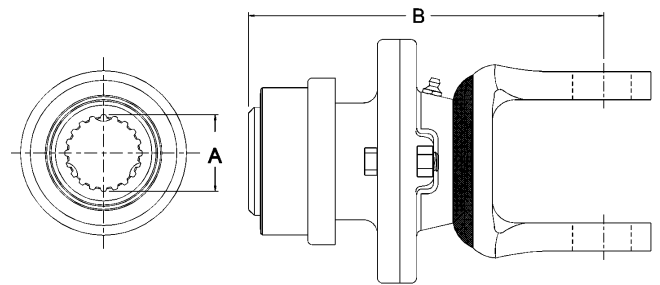

**595 STYLE**

Shear Pin

Order No.	Series	A	B	Dia.	Price	
595-3520	35N	1-3/4 x 20	7-3/8	3/8	\$412.25	
595-4420	44R	1-3/4 x 20	7-7/8	7/16	412.91	
595-5520	55N	1-3/4 x 20	8-13/16	7/16	667.08	
02010595	Repair Kit f/ 35N, 44R, 55N 20 Spline					55.45

DEALER SCHEDULE THIS PAGE.....203

**ALL PRICES SUBJECT TO CHANGE WITHOUT NOTICE.**

**SQUARE BORE YOKE**

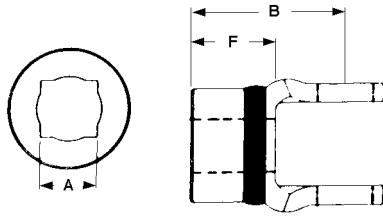

Order No.	Series	A	B	F	Price
183-0616	6N	1	2-1/2	1-1/8	\$27.50
183-0620	6N	1-1/4	2-1/2	1-1/8	27.50
183-1216	12N	1	3-1/2	2	37.90
183-1220	12N	1-1/4	3-1/2	2	37.90
183-3520	35N	1-1/4	4-5/32	2-3/16	86.03

**TORQUE TUBE WELD YOKE**

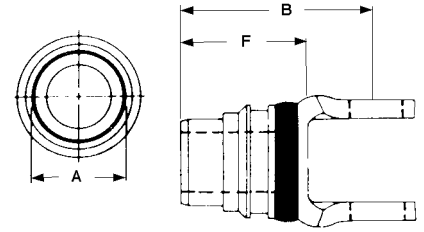

Order No.	Series	A	B	F	Price
181-0600	6N	1-15/32	3-9/16	2-3/16	\$28.50
181-1200	12N	1-13/16	4-13/32	2-1/2	37.26
181-1400	14N	1-13/16	4-1/32	2-11/32	39.89
181-3500	35N	1-7/8	4-5/8	2-11/16	55.00
181-4400	44R	2-15/64	5-13/32	2-7/8	82.18
181-5500	55N	2-15/64	5-9/16	2-13/16	166.71

**BAR WELD YOKE**

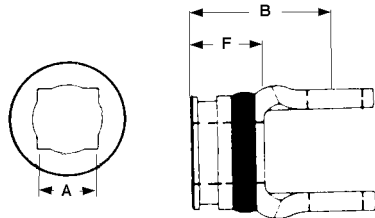

Order No.	Series	A	B	F	Price
177-0600	6N	3/4 x 7/8	2-17/32	1-3/16	\$22.95
177-1200	12N	1 x 1-1/8	2-29/32	1-3/8	31.84
177-1400	14N	1 x 1-1/8	3-5/32	1-15/32	36.38
177-3500	35N	1-3/16 Sq.	3-21/32	1-25/32	48.73
177-4400	44R	1-5/16 Sq.	4-7/32	1-11/16	80.38
177-5500	55N	1-3/8 Sq.	4-3/4	3-1/8	166.71

**SPLINE BORE YOKE**

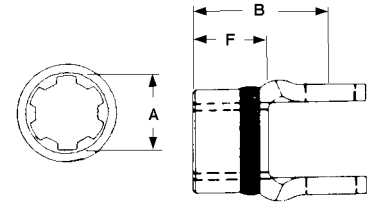

Order No.	Series	A	B	F	Price
192-0622	6N	1-3/8 x 6	2-1/2	1-1/8	\$27.50
192-1222	12N	1-3/8 x 6	3-1/2	2	37.90
192-1422	14N	1-3/8 x 6	3-1/2	1-3/4	40.66
192-3522	35N	1-3/8 x 6	4-5/32	2-3/16	86.03

ALL PRICES SUBJECT TO CHANGE WITHOUT NOTICE.

**TUBE WELD YOKE**

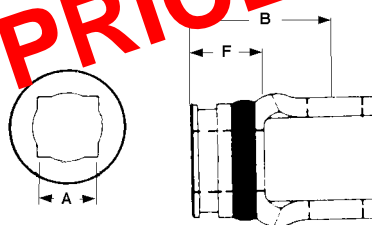

Order No.	Series	A	B	F	Price
180-0600	6N	1 x 1-1/8	2-17/32	1-3/16	\$25.15
180-1200	12N	1-9/32 x 1-13/32	2-29/32	1-3/8	31.84
180-1400	14N	1-9/32 x 1-13/32	3-5/32	1-15/32	39.23

Order No.	Yoke No.	Series	Counter Bore Dia.	Price
178-0600	179-0600	6N	1-1/2	\$67.60
178-1200	179-1200	12N	1-1/2	75.58
178-1400	179-1400	14N	1-1/2	97.24
178-3500	179-3500	35N	2	137.84

**Weld-A-Joint Yokes**

Order No.	Description	Price
179-0600	Yoke Only for 6N Weldajoint	\$19.47
179-1200	Yoke Only for 12N Weldajoint	25.89
179-1400	Yoke Only for 14N Weldajoint	40.66
179-3500	Yoke Only for 35N Weldajoint	55.00

DEALER SCHEDULE THIS PAGE.....203

**WELDAJOINTS**

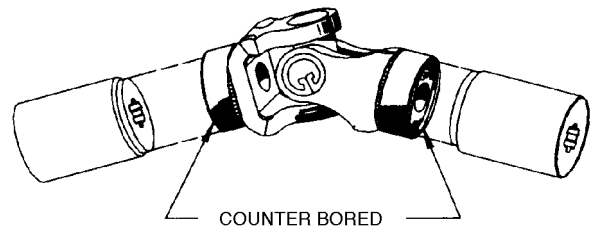

(Joints Use Standard Replacement Crosses)

WELDAJOINT BUSHINGS ON FOLLOWING PAGES

# WELDAJOINT BUSHINGS



## ROUND BORE

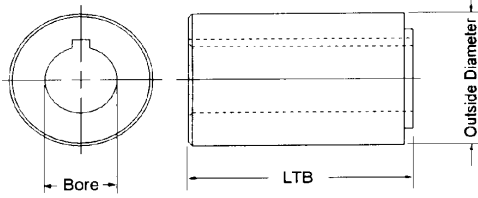

## RECTANGULAR BORE

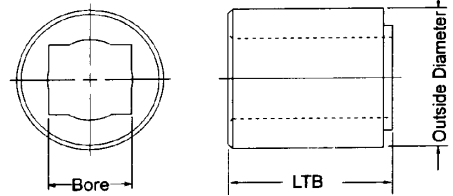

Order No.	Bore	O.D.	Fits U-Joint Series	Price
160-0800	1/2	1-1/2	K1C, 6N, 12N, 14N	\$12.18
160-1000	5/8	1-1/2	K1C, 6N, 12N, 14N	12.18
160-1100	11/16	1-1/2	K1C, 6N, 12N, 14N	12.18
160-1200	3/4	1-1/2	K1C, 6N, 12N, 14N	12.18
160-1400	7/8	1-1/2	K1C, 6N, 12N, 14N	12.18
160-1600	1	1-5/8	K1C, 6N, 12N, 14N	13.70
16001600	1	2	35N	18.90
160-1700	1-1/16	1-3/4	K1C, 6N, 12N, 14N	24.10
16001800	1-1/8	2	K1C, 6N, 12N, 14N, 35N	18.90
16002000	1-1/4	2	K1C, 6N, 12N, 14N, 35N	21.55
160-2200	1-3/8	2-1/8	K1C, 6N, 12N, 14N	24.10
16002200	1-3/8	2-1/4	35N	27.07
16002300	1-7/16	2-1/4	35N	25.30
160-2400	1-1/2	2-1/4	K1C, 6N, 12N, 14N	27.07
16002400	1-1/2	2-1/4	35N	27.07
16002800	1-3/4	2-1/2	35N	27.07

NOTE - - - All of the above are 2-1/4" in length.

Order No.	Bore	O.D.	Fits Series	Each
162-1214	3/4 x 7/8	1-5/8	K1C, 6N, 12N, 14N	\$20.48
16201618	1 x 1-1/8	2	K1C, 6N, 12N, 14N	26.69

The above are 2-1/4" in length.

## STAR BORE

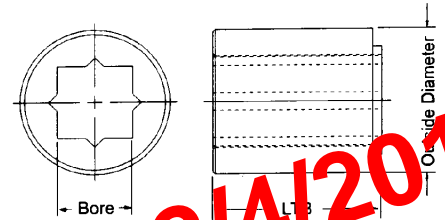

Order No.	Bore	O.D.	Fits Series	Each
16401416	7/8 & 1 SQ.	2	K1C, 6N, 12N, 35N	\$26.71

The above is 2-1/4" in length.

Made from cold rolled steel - - Machineable - - Weldable.  
We recommend using low hydrogen electrodes for welding Weldajoint parts. Rounds with keyway.

## SNAP HITCH BUSHINGS

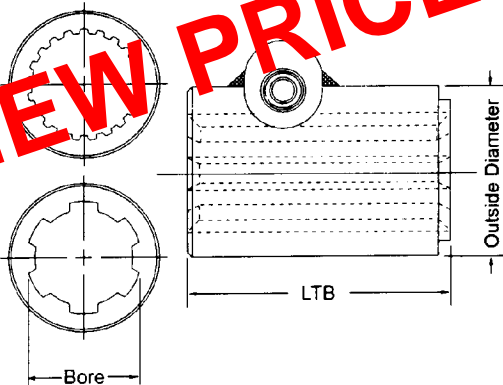

Order No.	Bore	Lgth.	Fits Series	Each
165-2206	1-3/8 x 6	3	K1C, 6N, 12N, 14N	\$47.02
165-2221	1-3/8 x 21	3	K1C, 6N, 12N, 14N	47.02

## BLOCK & PIN U-JOINTS

Furnished with 1/4 x 1/8 Keyway & (2) 5/16-18 Set Screws.  
Material: 1025 Cast Steel

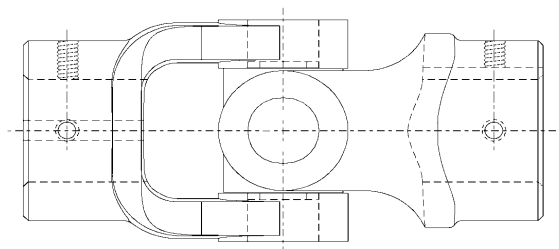

Order No.	Description	Price
UJPB-1	1" Rd. x 1" Rd. Block & Pin U-Joint	\$33.80

Max. Static Torque: 100 lb. ft.

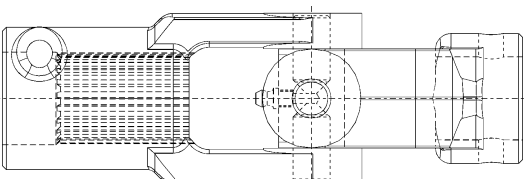

Material: 1025 Cast Steel

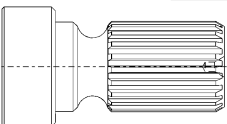

Material: 1025 Cast Steel.  
Zinc Plated

## TARP U-JOINTS

Order No.	Description	Price
UJY5	1-3/8-21 Spl. x 1-1/4 Rd.	\$61.32
UJY5-E	1-3/8-21 Spline Shaft	25.50

Max. Static Torque: 100 lb. ft.

# WELDAJOINT BUSHINGS

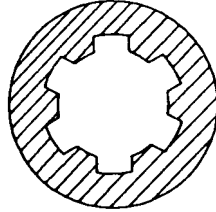

## SPLINE BORE

Order No.	Bore	O.D.	Lgth.	Fits U-Joint Series	Price
163-1413	7/8 x 13	1-1/2	2-1/4	K1C, 6N, 12N, 14N	\$15.34
163-1606	1 x 6	1-1/2	2-1/4	K1C, 6N, 12N, 14N	17.10
163-1615	1 x 15	1-1/2	2-1/4	K1C, 6N, 12N, 14N, 35N	17.10
163-1806	1-1/8 x 6	1-5/8	2-1/4	K1C, 6N, 12N, 14N	22.11
16302006	1-1/4 x 6	2	2-1/4	K1C, 6N, 12N, 14N, 35N	26.71
16302014	1-1/4 x 14	2	2-1/4	K1C, 6N, 12N, 14N, 35N	26.71
16302206	1-3/8 x 6	2	2-1/4	K1C, 6N, 12N, 14N, 35N	26.71
16702206	1-3/8 x 6	2	5	K1C, 6N, 12N, 14N, 35N	56.39
16602221	1-3/8 x 21	2	2-1/4	K1C, 6N, 12N, 14N, 35N	26.71
16302806	1-3/4 x 6	2-1/2	2-1/4	35N	41.86
16302820	1-3/4 x 20	2-1/2	2-1/4	35N	41.86

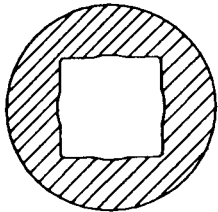

## SQUARE BORE WELDAJOINT BUSHINGS

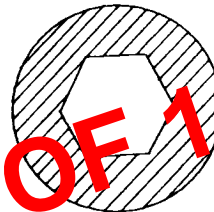

## HEXAGON BORE WELDAJOINT BUSHINGS

Order No.	Bore	O.D.	Fits U-Joint Series	Price
161-0800	1/2	1-1/2	K1C, 6N, 12N, 14N	\$15.13
161-1000	5/8	1-5/8	K1C, 6N, 12N, 14N	17.06
161-1200	3/4	1-5/8	K1C, 6N, 12N, 14N	17.06
161-1400	7/8	1-7/8	K1C, 6N, 12N, 14N	23.54
16101600	1	2	K1C, 6N, 12N, 14N, 35N	26.69
16101800	1-1/8	2	K1C, 6N, 12N, 14N, 35N	26.69
161-1900	1-3/16	2-1/4	K1C, 6N, 12N, 14N	33.77
16101900	1-3/16	2-1/4	35N	33.77
161-2000	1-1/4	2-1/4	K1C, 6N, 12N, 14N	33.77
16102000	1-1/4	2-1/4	35N	33.77
16102100	1-5/16	2-1/2	35N	41.54
16102200	1-3/8	2-1/2	35N	41.54
16102400	1-1/2	3	35N	60.54
16102600	1-5/8	3	35N	60.54

Order No.	Bore	O.D.	Fits U-Joint Series	Price
16801200	3/4	1-5/8	K1C, 6N, 12N, 14N	\$17.06
16801400	7/8	2	K1C, 6N, 12N, 14N, 35N	26.69
16801600	1	2	K1C, 6N, 12N, 14N, 35N	26.69
16801800	1-1/8	2	K1C, 6N, 12N, 14N, 35N	26.69
16802000	1-1/4	2-1/4	K1C, 6N, 12N, 14N, 35N	33.77

The above are 2-1/4" in length.

The above are 2-1/4" in length.

DEALER SCHEDULE THIS PAGE.....203

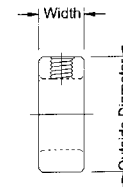
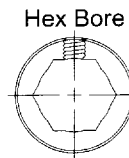

## HEX BORE SET COLLARS MILD STEEL

Order No.	Bore	O.D.	Width	Price
152H1000	5/8	1-1/2	9/16	\$10.38
152H1200	3/4	1-5/8	5/8	10.89
152H1400	7/8	1-3/4	5/8	11.51
152H1600	1	1-13/16	5/8	11.88
152H1800	1-1/8	2	5/8	12.84
152H2000	1-1/4	2-1/8	11/16	14.08

**Need it FAST?**  
**Over 95% of all orders**  
**Ship The Same Day!**



# SHAFT COUPLERS

Round and Hexagon Bore

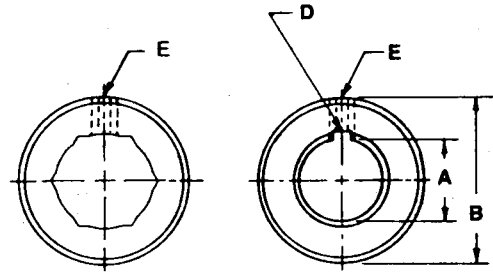
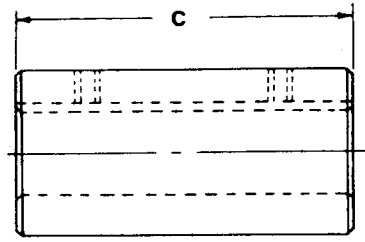

Order No.	A Bore	B O.D.	C Overall Length	D Keyway	E Set Screws	Price
126-0900	9/16 Hex	1-1/2	2-1/2	None	1/4-20	\$15.32
126-1000	5/8 Hex	1-1/2	2-1/2	None	1/4-20	15.95
126-1200	3/4 Hex	1-5/8	3	None	1/4-20	17.60
126-1400	7/8 Hex	1-3/4	3	None	1/4-20	21.55
126-1600	1 Hex	1-13/16	3	None	5/16-18	19.65
126-1800	1-1/8 Hex	2	4-1/2	None	5/16-18	26.08
126-2000	1-1/4 Hex	2-1/8	4-1/2	None	5/16-18	37.40
126-2400	1-1/2 Hex	2-3/4	4-1/2	None	1/2-13	39.00
126-2800	1-3/4 Hex	3	4-1/2	None	1/2-13	44.15
127-0800	1/2 Rd.	1-1/4	2	1/8	1/4-20	10.60
127-1000	5/8 Rd.	1-1/2	2-1/2	3/16	1/4-20	11.90
127-1200	3/4 Rd.	1-5/8	3	3/16	1/4-20	13.88
127-1400	7/8 Rd.	1-3/4	3-1/2	3/16	1/4-20	14.86
127-1600	1 Rd.	1-5/8	3	1/4	5/16-18	15.10
127-1604	1 Rd.	1-3/4	4	1/4	5/16-18	19.04
127-1800	1-1/8 Rd.	2	4-1/2	1/4	5/16-18	28.80
127-1900	1-3/16 Rd.	2	4-1/2	1/4	5/16-18	22.88
127-2000	1-1/4 Rd.	2-1/8	4-1/2	1/4	5/16-18	26.10
127-2005	1-1/4 Rd.	2-1/8	4-1/2	5/16	5/16-18	26.94
127-2200	1-3/8 Rd.	2-5/16	4-1/2	5/16	3/8-16	29.12
127-2300	1-7/16 Rd.	2-5/16	4-1/2	3/8	3/8-16	29.12
127-2400	1-1/2 Rd.	2-1/2	4-1/2	3/8	3/8-16	32.64
127-2600	1-5/8 Rd.	2-5/8	4-1/2	3/8	3/8-16	43.35
127-2800	1-3/4 Rd.	2-3/4	4-1/2	3/8	3/8-16	43.35
127-3100	1-15/16 Rd.	3-5/16	4-1/2	1/2	1/2-13	71.50
127-3200	2 Rd.	3-5/16	4-1/2	1/2	1/2-13	71.50

DEALER SCHEDULE.....203

NEW PRICES AS OF 12/4/2018

# G & G FLEX COUPLINGS

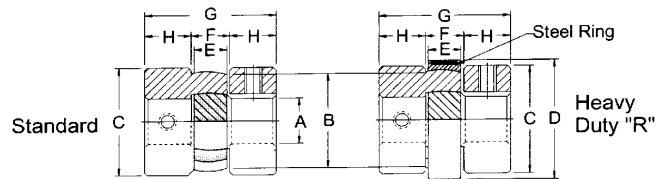
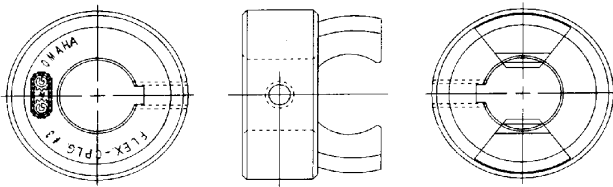

No.	A	B	C	D	E	F	G	H
3	1-1/8	2-1/4	2.35	3/4	7/8	2-7/8	1	1
3R	1-1/8	2-1/4	2.35	2-3/4	3/4	7/8	2-7/8	1

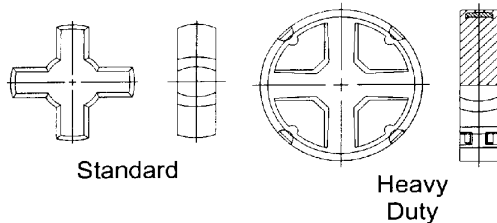

**Horsepower Ratings**

No.	100 RPM	870 RPM	1150 RPM	1750 RPM	3500 RPM
3	.42	3.70	4.89	7.45	14.90
3R	.64	5.62	7.42	11.30	22.00

Order No.	Coupling #	Bore	Price
233-0306	3	3/8"	\$32.10
233-0307	3	7/16"	32.10
233-0308	3	1/2"	32.10
233-0310	3	5/8"	32.10
233-0312	3	3/4"	32.10
233-0314	3	7/8"	32.10
233-0315	3	15/16"	32.10
233-0316	3	1"	32.10
233-0318	3	1-1/8"	32.10
234-0300	3	Std. Insert	10.92
234-H300	3	H.D. Insert	25.00

Dealer Schedule.....152

# TYPE L JAW COUPLINGS

Outside Diameter

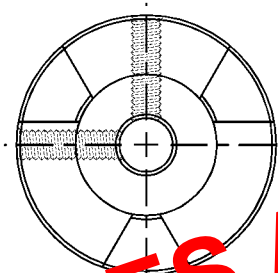
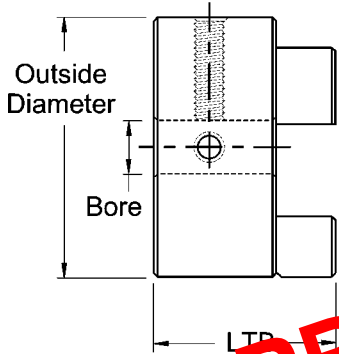
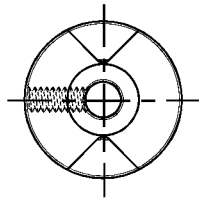
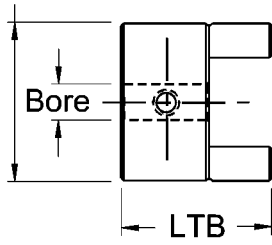

Order No.	Cpling No.	Jaws	Bore Size	Outside Dia.	LTB	Price
L05014NK5 ..	L050 .....	2 .....	1/4 .....	1-7/64 ..	1-1/16 ..	\$6.05
L05038NK5 ..	L050 .....	2 .....	3/8 .....	1-7/64 ..	1-1/16 ....	6.05
L0507165 .....	L050 .....	2 .....	7/16 .....	1-7/64 ..	1-1/16 ....	6.05
L050125 .....	L050 .....	2 .....	1/2 .....	1-7/64 ..	1-1/16 ....	6.05
L050585 .....	L050 .....	2 .....	5/8 .....	1-7/64 ..	1-1/16 ....	6.05
L075MPB5 ...	L075 .....	3 .....	1/4 .....	1-3/4 ...	1-9/32 ..	10.15
L0757165 .....	L075 .....	3 .....	7/16 .....	1-3/4 ...	1-9/32 ..	10.15
L075125 .....	L075 .....	3 .....	1/2 .....	1-3/4 ...	1-9/32 ..	10.15
L075585 .....	L075 .....	3 .....	5/8 .....	1-3/4 ...	1-9/32 ..	10.15
L075345 .....	L075 .....	3 .....	3/4 .....	1-3/4 ...	1-9/32 ..	10.15
L075785 .....	L075 .....	3 .....	7/8 .....	1-3/4 ...	1-9/32 ..	10.15
L095MPB5 ...	L095 .....	3 .....	1/4 .....	2-1/8 ...	1-1/2 ...	15.95
L0957165 .....	L095 .....	3 .....	7/16 .....	2-1/8 ...	1-1/2 ...	15.95
L095125 .....	L095 .....	3 .....	1/2 .....	2-1/8 ...	1-1/2 ...	15.95
L0959165 .....	L095 .....	3 .....	9/16 .....	2-1/8 ...	1-1/2 ...	15.95
L095585 .....	L095 .....	3 .....	5/8 .....	2-1/8 ...	1-1/2 ...	15.95
L095345 .....	L095 .....	3 .....	3/4 .....	2-1/8 ...	1-1/2 ...	15.95
L095785 .....	L095 .....	3 .....	7/8 .....	2-1/8 ...	1-1/2 ...	15.95
L09515165 .....	L095 .....	3 .....	15/16 .....	2-1/8 ...	1-1/2 ...	15.95
L0951185 .....	L095 .....	3 .....	1 .....	2-1/8 ...	1-1/2 ...	15.95
L0951185 .....	L095 .....	3 .....	1-1/8 .....	2-1/8 ...	1-1/2 ...	15.95
L100MPB5 ...	L100 .....	3 .....	1/4 .....	2-1/2 ...	2-1/32 ...	25.80
L100585 .....	L100 .....	3 .....	5/8 .....	2-1/2 ...	2-1/32 ...	25.80
L100345 .....	L100 .....	3 .....	3/4 .....	2-1/2 ...	2-1/32 ...	25.80
L100785 .....	L100 .....	3 .....	7/8 .....	2-1/2 ...	2-1/32 ...	25.80
L10015 .....	L100 .....	3 .....	1 .....	2-1/2 ...	2-1/32 ...	25.80
L1001185 .....	L100 .....	3 .....	1-1/8 .....	2-1/2 ...	2-1/32 ...	25.80
L1001145 .....	L100 .....	3 .....	1-1/4 .....	2-1/2 ...	2-1/32 ...	25.80
L1001385 .....	L100 .....	3 .....	1-3/8 .....	2-1/2 ...	2-1/32 ...	25.80
L1001125 .....	L100 .....	3 .....	1-1/2 .....	2-1/2 ...	2-1/32 ...	25.80
L110MPB5 ...	L110 .....	3 .....	1/4 .....	3-11/32 ..	2-1/2 ...	43.85
L110585 .....	L110 .....	3 .....	5/8 .....	3-11/32 ..	2-1/2 ...	43.85
L110345 .....	L110 .....	3 .....	3/4 .....	3-11/32 ..	2-1/2 ...	43.85
L110785 .....	L110 .....	3 .....	7/8 .....	3-11/32 ..	2-1/2 ...	43.85
L11015 .....	L110 .....	3 .....	1 .....	3-11/32 ..	2-1/2 ...	43.85
L1101185 .....	L110 .....	3 .....	1-1/8 .....	3-11/32 ..	2-1/2 ...	43.85
L1101145 .....	L110 .....	3 .....	1-1/4 .....	3-11/32 ..	2-1/2 ...	43.85
L1101385 .....	L110 .....	3 .....	1-3/8 .....	3-11/32 ..	2-1/2 ...	43.85
L1101125 .....	L110 .....	3 .....	1-1/2 .....	3-11/32 ..	2-1/2 ...	43.85
L1101585 .....	L110 .....	3 .....	1-5/8 .....	3-11/32 ..	2-1/2 ...	43.85

**NEW PRICES AS OF 12/14/2018**

## L-JAW COUPLING RATING

Coupling Number	Rated Torque (Horsepower Capacity at Varying Speeds RPM)						Max. Bore
	100	300	1200	1800	3600		
L-050	28.1	0.04	0.12	0.48	0.72	1.44	5/8
L-075	73	0.12	0.36	1.44	2.16	4.32	1-1/32
L-090	126	0.20	0.60	2.40	3.60	7.20	1-1/8
L-095	169	0.28	0.84	3.36	5.04	10.08	1-1/8
L-099	260	0.42	1.26	5.04	7.56	15.10	1-13/32
L-100	370	0.60	1.80	7.20	10.8	21.60	1-13/32
L-110	680	1.10	3.30	13.20	19.8	39.60	1-7/8

# BUNA-N SPIDER COUPLING INSERTS

Order No.	Coupling No.	Each
L050N5 .....	L050N .....	\$2.45
L075N5 .....	L075N .....	5.70
L090N5 .....	L090/095N .....	6.05
L099N5 .....	L099/100N .....	12.00
L110N5 .....	L110N .....	19.40

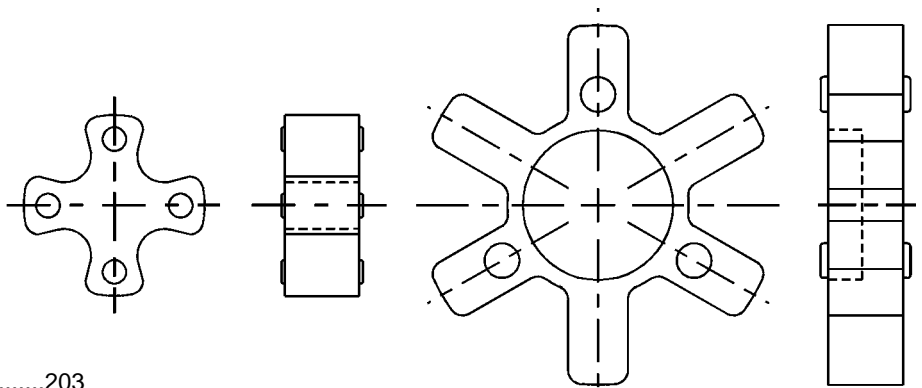

# G&G ROLLER CHAIN FLEXIBLE COUPLING

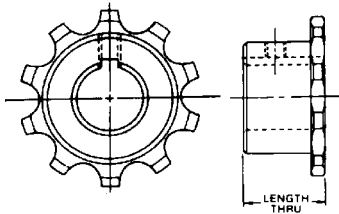

**COUPLING HALF**

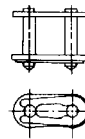
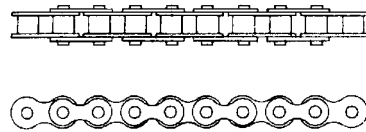

## COUPLING CHAIN

Order No.	Chain Size	No. of Teeth	Each
030-1050	50	10	\$12.99
030-1060	60	10	18.66
030-1260	60	12	21.87
030-1280	80	12	46.18

Order No.	Bore	No. of Teeth	Chain Size	O.D	Lgth Thru	Each
029-1000	5/8	10	50	2-19/32	1-1/8	\$23.07
029-1200	3/4	10	50	2-19/32	1-1/8	23.07
029-1400	7/8	10	50	2-19/32	1-1/8	23.07
031-1000	5/8	10	60	3-1/8	1-1/4	31.37
031-1200	3/4	10	60	3-1/8	1-1/4	31.37
031-1400	7/8	10	60	3-1/8	1-1/4	31.37
031-1500	15/16	10	60	3-1/8	1-1/4	31.37
031-1600	1	10	60	3-1/8	1-1/4	31.37
031-1800	1-1/8	10	60	3-1/8	1-1/4	31.37
032-1000	5/8	12	60	3-9/16	1-7/16	38.09
032-1200	3/4	12	60	3-9/16	1-7/16	38.09
032-1400	7/8	12	60	3-9/16	1-7/16	38.09
032-1500	15/16	12	60	3-9/16	1-7/16	38.09
032-1600	1	12	60	3-9/16	1-7/16	38.09
032-1800	1-1/8	12	60	3-9/16	1-7/16	38.09
032-1900	1-3/16	12	60	3-9/16	1-7/16	38.09
032-2000	1-1/4	12	60	3-9/16	1-7/16	38.09
032-2200	1-3/8	12	60	3-9/16	1-7/16	38.09
032-2300	1-7/16	12	60	3-9/16	1-7/16	38.09
033-1600	1	12	80	4-25/32	2	70.60
033-1800	1-1/8	12	80	4-25/32	2	70.60
033-2000	1-1/4	12	80	4-25/32	2	70.60
033-2200	1-3/8	12	80	4-25/32	2	70.60
033-2400	1-1/2	12	80	4-25/32	2	70.60
033-2800	1-3/4	12	80	4-25/32	2	70.60

Furnished with standard keyway and set screw.

## COUPLER SPROCKETS

(FITS LINK-BELT NO. 50 COUPLER CHAIN)

Order No.	Bore	No. of Teeth	Chain Size	Hub Dia.	Lgth. Thru	Each
025-1000	5/8	12	50	1-15/16	1-1/4	\$30.86
025-1400	7/8	12	50	1-15/16	1-1/4	30.86
025-1600	1	12	50	1-15/16	1-1/4	30.86
025-1800	1-1/8	12	50	1-15/16	1-1/4	30.86
025-2000	1-1/4	12	50	1-15/16	1-1/4	30.76
027-1600	1	16	50	2-17/32	1-7/16	44.82

Furnished with standard keyway and set screw.

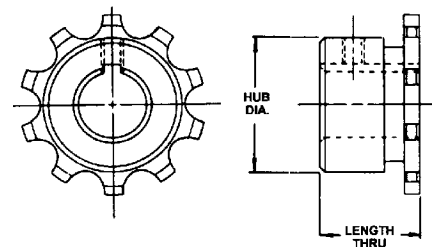

ALL PRICES SUBJECT TO CHANGE WITHOUT NOTICE.

DEALER SCHEDULE THIS PAGE.....203

**Rely on Central Supply for Fast Shipment of your order!**

# G & G Hardened Tooth Weld-A-Sprockets

Standard Hardness is Rockwell "C" 35 to 50.

The teeth are induction hardened leaving the area around the bore soft for reborring or welding.

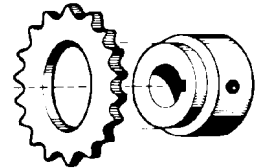

#40 Chain				# 50 Chain continued				# 60 Chain continued			
Order No.	Series	Teeth	Price	Order No.	Series	Teeth	Price	Order No.	Series	Teeth	Price
00304012	V	12	\$12.65	00305016	W	16	\$20.95	00306018	X or XX	18	\$34.90
00304013	V	13	13.25	00305017	X	17	22.08	00306019	X or XX	19	37.56
00304014	V	14	13.87	00305018	X	18	23.24	00306020	X or XX	20	40.10
00304015	V	15	14.53	00305019	X	19	24.37	00306021	X or XX	21	42.80
00304016	W	16	15.52	00305020	X or XX	20	25.74	00306022	X or XX	22	45.62
00304017	W	17	16.37	00305021	X or XX	21	27.11	00306023	X or XX	23	48.45
00304018	W	18	17.12	00305022	X or XX	22	28.63	00306024	X or XX	24	51.47
00304019	W	19	18.02	00305023	X or XX	23	30.11	00306025	X or XX	25	54.10
00304020	X	20	18.90	00305024	X or XX	24	31.67	00306026	X or XX	26	57.39
00304021	X	21	19.88	00305025	X or XX	25	33.30	00306027	X or XX	27	67.15
00304022	X	22	20.76	00305026	X or XX	26	34.84	00306028	X or XX	28	70.92
00304023	X	23	21.94	00305027	X or XX	27	38.20	00306029	X or XX	29	75.80
00304024	X or XX	24	22.79	00305028	X or XX	28	39.93	00306030	X or XX	30	79.65
00304025	X or XX	25	23.93	00305029	X or XX	29	41.62				
00304026	X or XX	26	24.93	00305030	X or XX	30	43.61				
00304027	X or XX	27	25.77								
00304028	X or XX	28	26.60								
00304029	X or XX	29	27.50								
00304030	X or XX	30	28.83								
# 50 Chain				#60 Chain				#80 Chain			
Order No.	Series	Teeth	Price	Order No.	Series	Teeth	Price	Order No.	Series	Teeth	Price
00305010	V	10	13.74	00306009	V	9	17.31	00308009	W	9	\$29.49
00305011	V	11	14.94	00306010	V	10	18.66	00308010	W	10	32.53
00305012	W	12	16.05	00306011	W	11	20.22	00308011	W	11	35.85
00305013	W	13	17.36	00306012	W	12	21.70	00308012	X	12	39.40
00305014	W	14	18.49	00306013	W	13	23.63	00308013	X	13	43.70
00305015	W	15	19.65	00306014	W	14	25.55	00308014	X or XX	14	47.55
				00306015	X	15	27.76	00308015	X or XX	15	51.51
				00306016	X	16	30.00	00308016	X or XX	16	56.24
				00306017	X or XX	17	32.53	00308017	X or XX	17	61.80
								00308018	X or XX	18	66.17
								00308019	X or XX	19	71.28
								00308020	X or XX	20	77.32

Dealer Schedule.....203

## WELDASPROCKETS

For Steel Pintle Chain  
Steel Detachable Chain  
and Implement Roller Chain

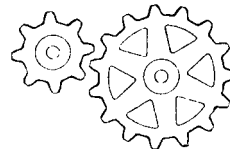
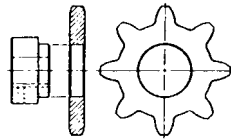

## CAST IRON STOCK BORE SPROCKETS

For Steel Detachable Chain Only

CHAIN NO. A550				
Order No.	No. of Teeth	O.D.	Fits Hub Series	Each
01550655	6	3-3/4	W	\$35.59
01550755	7	4-1/4	X	39.40
01550855	8	4-3/4	X	43.96
01550955	9	5-1/4	X	51.13
01551055	10	5-3/4	X	57.16
01551155	11	6-1/4	X	68.16
01551255	12	6-3/4	X	80.57
01551355*	13	7-1/4	X	87.42
01551455*	14	7-3/4	X	98.38
01551555*	15	8-1/2	X	104.73

CHAIN NO. A620				
Order No.	No. of Teeth	O.D.	Fits Hub Series	Each
01620662	6	3-7/8	W	\$58.66
01620762	7	4-1/2	W	64.48
01620862	8	4-7/8	X	69.59
01620962	9	5-3/8	X	76.21
01621062	10	5-7/8	X	83.14
01621162	11	6-1/2	X	96.81
01621262	12	7	X	103.19
01621362*	13	7-1/2	Y	105.95
01621462*	14	8	Y	111.75
01621562*	15	8-1/2	Y	128.91

Dealer Schedule:

Stock Items.....203

\*Non-Stock Items.....102

### CHAIN NO. 55 ALSO FITS NO. 45

Order No.	No. of Teeth	O.D.	Rough Stock Bore Size	Each
01350655	6	3-3/4	3/4	\$16.76
01350755	7	4-1/4	1/2	13.76
01350855	8	4-3/4	3/4	15.66
01350955	9	5-1/4	3/4	20.20
01351055	10	5-3/4	3/4	27.48
01351155	11	6-1/4	3/4	31.84
01351255	12	6-3/4	3/4	32.30
01351555	15	8-3/8	7/8	32.64

### CHAIN NO. 62 ALSO FITS NO. 72-1/2

01360662	6	3-7/8	3/4	13.26
01360762	7	4-1/2	3/4	13.76
01360862	8	4-7/8	3/4	15.66
01361062	10	5-7/8	3/4	27.48

### CHAIN NO. 67H ALSO FITS NO. 667 Pintle Chain (Will Not Work on 67-T bar links)

01370667	6	4-7/8"	3/4"	74.04
01370867	8	6-1/2"	3/4"	75.04

Dealer Schedule.....203

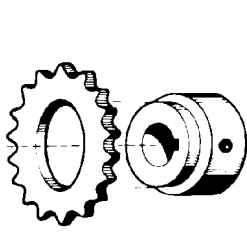

# WELDASPROCKETS

Factory recommends using Low Hydrogen Electrodes for welding Weldasprocket parts.

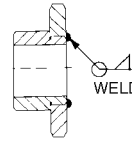

The smaller sprockets are to be welded as shown so the weld will not interfere with the chain.

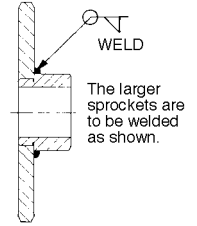

The larger sprockets are to be welded as shown.

No. 35 Roller Chain (3/8" Pitch)

Sprocket Order No.	No. of Teeth	Outside Diam.	Hub Series	Each
00103515	15	1.989	V	\$6.86
00103516	16	2.110	V	6.96
00103517*	17	2.231	V	7.16
00103518*	18	2.352	V	7.28
00103519*	19	2.472	V	7.40
00103520*	20	2.593	V	7.60
00103521*	21	2.713	V	7.90
00103522*	22	2.833	W	8.20
00103523*	23	2.953	W	8.40
00103524*	24	3.074	W	8.68
00103525*	25	3.194	W	8.76
00103526*	26	3.314	W	8.80
00103527*	27	3.434	W	9.20
00103528*	28	3.553	W	9.60
00103530*	30	3.793	W	10.16
00103532*	32	4.032	W	10.70
00103535*	35	4.390	W	12.30
00103536*	36	4.511	W	11.82
00103540*	40	4.990	W	13.20
00103545	45	5.588	W	14.86
00103548*	48	5.946	W	16.34
00103554	54	6.664	W	18.94
00103560	60	7.381	W	22.54
00103572	72	8.814	W	28.34
00103584*	84	10.247	W	34.74
00103596*	96	11.680	W	43.36

No. 41 Roller Chain (1/2" Pitch)

00104112	12	2.166	V	5.50
00104113*	13	2.329	V	5.78
00104114*	14	2.491	V	6.00
00104115*	15	2.653	V	6.26
00104116*	16	2.814	W	6.44
00104117*	17	2.975	W	6.84
00104118*	18	3.136	W	7.14
00104119*	19	3.297	W	7.36
00104120*	20	3.457	W	7.74
00104121*	21	3.618	W	8.18
00104122*	22	3.778	W	8.62
00104123*	23	3.938	W	9.22
00104124*	24	4.098	W	9.62
00104125*	25	4.258	W	10.10
00104126*	26	4.418	W	10.90
00104127*	27	4.578	W	11.65
00104128*	28	4.738	W	12.05
00104130*	30	5.057	W	13.30
00104132*	32	5.377	W	14.95
00104135*	35	5.856	W	15.68
00104136*	36	6.015	W	17.60
00104140	40	6.653	W	19.80
00104142*	42	6.972	W	21.15
00104145	45	7.451	W	24.05
00104148	48	7.927	W	28.15
00104154	54	8.885	W	33.90
00104160*	60	9.841	W	41.50
00104172*	72	11.752	W	61.56

No. 40 Roller Chain (1/2" Pitch)

Sprocket Order No.	No. of Teeth	Outside Diam.	Hub Series	Each
00104012	12	2.166	V	\$5.20
00104013	13	2.329	V	5.32
00104014	14	2.491	V	5.52
00104015	15	2.653	V	6.00
00104016	16	2.814	W	6.15
00104017	17	2.975	W	6.86
00104018	18	3.136	W	7.40
00104019	19	3.297	W	7.60
00104020	20	3.457	X	7.95
00104021	21	3.618	X	8.80
00104022	22	3.778	X	9.40
00104023	23	3.938	X	10.12
00104024	24	4.098	X	10.85
00104025	25	4.258	X	11.35
00104026	26	4.418	X	11.70
00104027	27	4.578	X	12.20
00104028	28	4.738	X	12.60
00104029	29	4.898	X	13.10
00104030	30	5.057	X	13.70
00104032	32	5.377	X	14.75
00104035	35	5.856	X	16.91
00104036	36	6.015	X	17.70
00104038	38	6.334	X	21.71
00104040	40	6.653	X	20.53
00104042	42	6.972	X	23.10
00104045	45	7.451	X	25.50
00104046	46	7.609	X	39.35
00104048	48	7.927	X	28.55
00104054	54	8.885	X	35.45
00104060	60	9.841	X	41.35
00104070	70	11.434	X	56.90
00104072	72	11.752	X	89.40
00104080*	80	13.026	X	74.18
00104084*	84	13.663	X	95.05
00104096*	96	15.573	X	98.70
001040112*	112	18.125	X	176.14

No. 50 Roller Chain (5/8" Pitch)

00105010	10	2.299	V	6.00
00105011	11	2.504	V	7.10
00105012	12	2.708	W	7.30
00105013	13	2.911	W	7.60
00105014	14	3.114	W	7.90
00105015	15	3.316	W	8.55
00105016	16	3.517	W	8.80
00105017	17	3.719	X	9.95
00105018	18	3.919	X	10.35
00105019	19	4.121	X	11.00
00105020	20	4.321	X	12.60
00105021	21	4.521	X	12.80
00105022	22	4.722	X	13.30
00105023	23	4.922	X	14.05
00105024	24	5.123	X	14.60
00105025	25	5.323	X	15.80

Dealer Schedule: (All Except \*) ..... 203  
 \* Denotes Dealer Schedule ..... 102

No. 50 Roller Chain Sprockets (5/8" Pitch)  
 Continued on Next Page

ALL PRICES SUBJECT TO CHANGE WITHOUT NOTICE.

Note - - - Hub NOT Included in Price

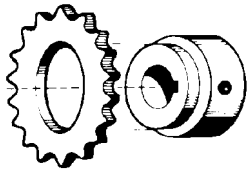

## WELDASPROCKETS

### No. 50 Roller Chain (5/8" Pitch) Continued

Sprocket Order No.	No. of Teeth	Outside Diam.	Hub Series	Each
00105026	26	5.523	X	\$17.15
00105027	27	5.723	X	18.80
00105028	28	5.922	X	18.90
00105029	29	6.122	X	19.40
00105030	30	6.321	X	20.55
00105031	31	6.521	X	21.20
00105032	32	6.721	X	22.05
00105033	33	6.920	X	23.10
00105034	34	7.120	X	26.00
00105035	35	7.319	X	27.40
00105036	36	7.519	X	29.10
00105037	37	7.718	X	41.34
00105038	38	7.918	X	31.80
00105039	39	8.117	X	44.84
00105040	40	8.316	X	34.40
00105041	41	8.516	X	48.50
00105042	42	8.715	X	37.35
00105043	43	8.914	X	54.20
00105044	44	9.114	X	40.75
00105045	45	9.313	X	42.50
00105048	48	9.911	X	47.25
00105050	50	10.309	X	50.56
00105052	52	10.708	X	60.10
00105054	54	11.106	X	64.30
00105060	60	12.306	X	70.90
00105065*	65	13.296	X	89.80
00105070	70	14.292	X	100.35
00105072	72	14.690	X	129.95
00105080*	80	16.283	X	159.00
00105084*	84	17.079	X	150.40
00105096*	96	19.466	X	249.70
001050112	112	22.650	X	287.89

### No. 60 Roller Chain (3/4" Pitch)

Sprocket Order No.	No. of Teeth	Outside Diam.	Hub Series	Each
00106009	9	2.510	V	7.95
00106010	10	2.759	V	8.60
00106011	11	3.005	W	9.35
00106012	12	3.249	W	10.15
00106013	13	3.493	W	10.35
00106014	14	3.747	W	11.40
00106015	15	3.979	X	12.75
00106016	16	4.220	X	13.10
00106017	17	4.463	X	14.25
00106018	18	4.703	X	14.60
00106019	19	4.945	X	15.80
00106020	20	5.186	X	19.05
00106021	21	5.426	X	20.95
00106022	22	5.666	X	22.85
00106023	23	5.906	X	24.25
00106024	24	6.147	X	26.15
00106025	25	6.387	X	29.60
00106026	26	6.627	X	28.05
00106027	27	6.867	X	30.25
00106028	28	7.106	X	32.30
00106029	29	7.346	X	33.90
00106030	30	7.586	X	35.75
00106031	31	7.826	X	38.80
00106032	32	8.065	X	40.60
00106033	33	8.304	X	65.40
00106034	34	8.544	X	46.30
00106035	35	8.783	X	48.15

Dealer Schedule: (All Except \*) ..... 203  
 \* Denotes Dealer Schedule ..... 102

NOTE - - - Hub NOT Included In Price.

### No. 60 Roller Chain (3/4" Pitch) Continued

Sprocket Order No.	No. of Teeth	Outside Diam.	Hub Series	Each
00106036	36	9.023	X	\$49.15
00106038	38	9.501	X	56.10
00106039	39	9.740	X	85.47
00106040	40	9.980	X	61.25
00106041	41	10.291	X	63.50
00106042	42	10.458	X	65.70
00106045	45	11.176	X	68.75
00106048	48	11.893	X	85.20
00106050*	50	12.371	X	92.20
00106054	54	13.327	X	105.90
00106060	60	14.761	X	120.70
00106072*	72	17.628	X	223.70
00106080*	80	19.539	X	295.62

### No. 80 Roller Chain (1" Pitch)

Sprocket Order No.	No. of Teeth	Outside Diam.	Hub Series	Each
00108009	9	3.347	W	15.00
00108010	10	3.678	W	15.25
00108011	11	4.000	W	15.60
00108012	12	4.332	X	16.20
00108013	13	4.657	X	17.70
00108014	14	4.982	X	20.10
00108015	15	5.305	X	22.10
00108016	16	5.627	X	24.60
00108017	17	5.950	X	28.15
00108018	18	6.271	X	32.35
00108019	19	6.593	X	36.15
00108020	20	6.914	X	40.75
00108021	21	7.235	X	44.65
00108022	22	7.555	X	48.20
00108023	23	7.875	X	71.43
00108024	24	8.196	X	52.25
00108025*	25	8.516	X	54.60
00108026	26	8.836	X	57.60
00108027*	27	9.156	X	100.70
00108028	28	9.475	X	63.20
00108029*	29	9.795	X	99.42
00108030*	30	10.114	X	74.85
00108032*	32	10.753	X	94.61
00108033*	33	11.072	X	98.35
00108034*	34	11.392	X	132.55
00108035*	35	11.711	X	139.19
00108036*	36	12.030	X	112.65
00108040*	40	13.306	X	132.45
00108045*	45	14.901	X	220.55
00108048*	48	15.857	X	247.85
00108060*	60	19.681	Y	259.30

### No. 100 Roller Chain (1-1/4" Pitch)

Sprocket Order No.	No. of Teeth	Outside Diam.	Hub Series	Each
00110010*	10	4.598	X	53.54
00110011*	11	5.008	X	57.87
00110012*	12	5.415	X	63.41
00110013*	13	5.821	X	69.06
00110014*	14	6.228	Y	74.84
00110015*	15	6.631	Y	80.55
00110016*	16	7.034	Y	85.84
00110017*	17	7.438	Y	91.10
00110018*	18	7.839	Y	96.15
00110019*	19	8.241	Y	103.21
00110020*	20	8.643	Y	110.79
00110021*	21	9.044	Y	120.27
00110022*	22	9.444	Y	130.11
00110023*	23	9.844	Y	140.02
00110024*	24	10.245	Y	150.57
00110025*	25	10.645	Y	158.79
00110026*	26	11.045	Y	166.68
00110028*	28	11.844	Y	180.36
00110030*	30	12.643	Y	197.59
00110032*	32	13.441	Y	227.20
00110035*	35	14.639	Y	264.68
00110036*	36	15.040	Y	277.77

NEW PRICES AS OF 12/4/2018

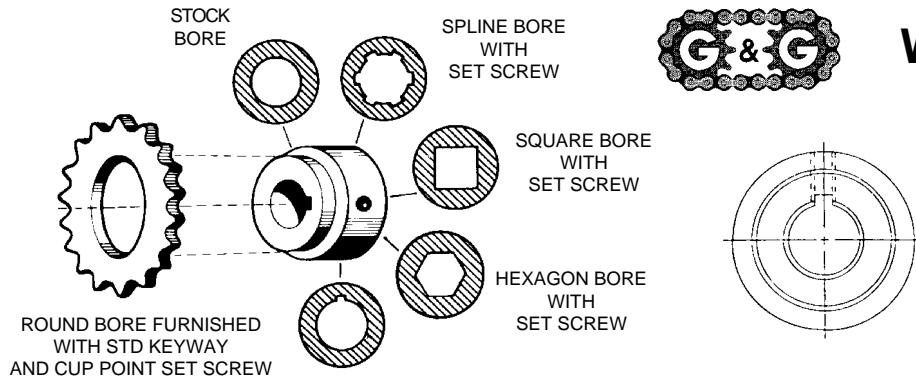

# WELDAHUBS

Factory recommends using Low Hydrogen Electrodes for welding Weldasprocket parts.

V Series Hubs	W Series Hubs	X Series Hubs	XX Series Hubs	Y Series Hubs
A=1-1/8"	A=1-5/8"	A=2"	A=2"	A=2-3/4"
B=1-7/16"	B=1-13/16"	B=2-1/2"	B=3"	B=3-3/4"
C=7/16"	C=7/16"	C=7/16"	C=7/16"	C=1-1/8"
D=3/4"	D=1"	D=1"	D=1-1/16"	D=1-1/8"
E=1-3/16"	E=1-7/16"	E=1-7/16"	E=1-1/2"	E=1-3/8"

NEW PRICES AS OF 12/4/2018

ROUND BORE				ROUND BORE (Continued)				STOCK BORE			
Order No.	Series	Bore	Each	Order No.	Series	Bore	Each	Order No.	Series	Bore	Each
00010008	V	1/2	\$6.30	00040022	XX	1-3/8	\$24.70	00020000	W	1/2	\$7.45
00010009	V	9/16	6.30	00040023	XX	1-7/16	24.70	00030000	X	19/32	10.55
00010010	V	5/8	6.30	00040024	XX	1-1/2	24.70	HEXAGON BORE			
00010011	V	11/16	6.30	00040026	XX	1-5/8	24.70	00026009	W	9/16	12.80
00010012	V	3/4	6.30	00050016	Y	1	41.99	00026010	W	5/8	12.80
00010013	V	13/16	6.30	00050017*	Y	1-1/16	41.99	00026012	W	3/4	12.80
00010014	V	7/8	6.30	00050018*	Y	1-1/8	41.99	00026014	W	7/8	12.80
00020008	W	1/2	8.05	00050019*	Y	1-3/16	41.99	00026016	W	1	12.80
00020009	W	9/16	8.05	00050020	Y	1-1/4	41.99	00026018	W	1-1/8	12.80
00020010	W	5/8	8.05	00050021*	Y	1-5/16	41.99	00026020	W	1-1/4	12.80
00020011	W	11/16	8.05	00050022*	Y	1-3/8	41.99	00036009	X	9/16	15.90
00020012	W	3/4	8.05	00050023*	Y	1-7/16	41.99	00036010	X	5/8	15.90
00020013	W	13/16	8.05	00050024*	Y	1-1/2	41.99	00036012	X	3/4	15.90
00020014	W	7/8	8.05	00050026*	Y	1-5/8	41.99	00036014	X	7/8	15.90
00020015	W	15/16	8.05	00050027*	Y	1-11/16	41.99	00036016	X	1	15.90
00020016	W	1	8.05	00050028*	Y	1-3/4	41.99	00036018	X	1-1/8	15.90
00020017	W	1-1/16	8.05	00050030*	Y	1-7/8	41.99	00036020	X	1-1/4	15.90
00020018	W	1-1/8	8.05	00050031*	Y	1-15/16	41.99	SQUARE BORE			
00020019	W	1-3/16	8.05	00050032*	Y	2	41.99	0002S010*	W	5/8	21.12
00020020	W	1-1/4	8.05	SPLINE BORE				0002S012	W	3/4	21.12
00030010	X	5/8	10.55	00021413	W	7/8x13	18.32	0002S014*	W	7/8	21.12
00030011	X	11/16	10.55	00021606	W	1x6	18.32	0002S016	W	1	21.12
00030012	X	3/4	10.55	00021615*	W	1x15	18.32	0003S012*	X	3/4	22.11
00030013	X	13/16	10.55	00021806	W	1-1/8x6	18.32	0003S014	X	7/8	22.11
00030014	X	7/8	10.55	00022006	W	1-1/4x6	18.32	0003S015*	X	15/16	22.11
00030015	X	15/16	10.55	00022014	W	1-1/4 x14	18.32	0003S016	X	1	22.11
00030016	X	1	10.55	00022206	W	1-3/8x6	18.32	0003S018	X	1-1/8	22.11
00030017	X	1-1/16	10.55	00022221	W	1-3/8x21	18.32	0003S020	X	1-1/4	22.11
00030018	X	1-1/8	10.55	00031413*	X	7/8x13	25.40	METRIC ROUND BORE			
00030019	X	1-3/16	10.55	00031606*	X	1x6	25.40	Order No.	Series	Bore	Each
00030020	X	1-1/4	10.55	00032006	X	1-1/4x6	25.40	00020025M	W	25MM	\$18.32
00030021	X	1-5/16	10.55	00032014	X	1-1/4x14	25.40	00030025M	X	25MM	25.40
00030022	X	1-3/8	10.55	00032206	X	1-3/8x6	25.40	00030030M	X	30MM	25.40
00030023	X	1-7/16	10.55	00032221	X	1-3/8x21	25.40	Weld-A-Hubs Continued On Next Page.			
00030024	X	1-1/2	10.55	00032806	X	1-3/4x6	25.40	<div style="border: 2px solid black; border-radius: 15px; padding: 10px; display: inline-block;"> <p style="margin: 0;"><b>Central Supply!</b></p> <p style="margin: 0; font-size: 1.2em;"><b>1-800-444-8666</b></p> </div>			
00040016	XX	1	24.70	00042820*	XX	1-3/4x20	30.86				
00040018	XX	1-1/8	24.70								
00040020	XX	1-1/4	24.70								

Dealer Schedule (except \*).....203 \* Denotes Dealer Schedule.....102

ALL PRICES SUBJECT TO CHANGE WITHOUT NOTICE

**ROUND BORE WELD-A-HUB  
(With Special Keyway)**

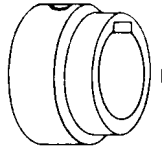

Order No	Series	Bore	Keyway	Price
00030520	X	1-1/4	.5/16	\$23.13

Dealer Schedule ..... 203

**COUPLER HUBS**

End To End Shaft Couplers - - Same Or Different Size Shafts

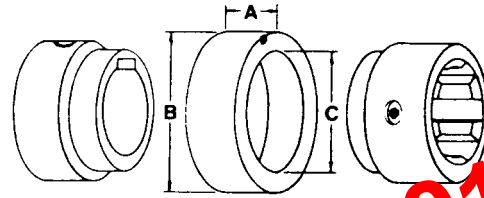

Stock No.	Series	Thru Bore	O.D.	I.D.
012-3226	W	1"	2"	1-5/8"
012-4032	X	1"	2-1/2"	2"

Order No.	Price
012-3226 ..... Coupler Hub for W Series	\$7.68
012-4032 ..... Coupler Hub for X Series	11.86

Dealer Schedule ..... 203

**O.E.M. WELD-ON HUBS**

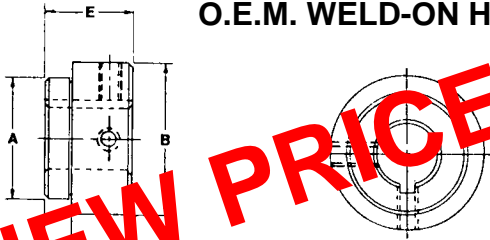

Round bore with standard keyway and **Two Set Screws.**

Hub Dimensions: A-2", B-2-1/2", C-7/16", D-1", E-1-7/16".

Other sizes are available. Dimensions and prices on request.

No.	Bore	Series	Price
008-6116	1 in.	X	\$10.55
008-6118	1-1/8 in.	X	10.55
008-6120	1-1/4 in.	X	10.55
008-6122	1-3/8 in.	X	10.45
008-6124	1-1/2 in.	X	10.55

Dealer Schedule.....152

**WELDASPROCKET DOUBLE HUBS**

(Fits X Series Weldasprockets For Double Chain)

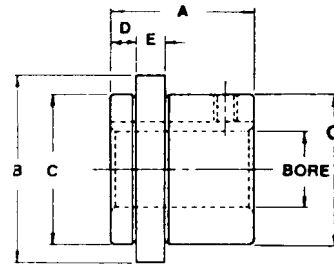

Order No.	Bore	Series	A	D	E	Each
000X4020	1-1/4	40	1-5/8	1/4	.291	\$37.32
000X5012	3/4	50	1-7/8	5/16	.376	37.32
000X5014	7/8	50	1-7/8	5/16	.376	37.32
000X5016	1	50	1-7/8	5/16	.376	37.32
000X5020	1-1/4	50	1-7/8	5/16	.376	37.32
000X6012	3/4	60	2-1/4	7/16	.449	37.32
000X6014	7/8	60	2-1/4	7/16	.449	37.32
000X6016	1	60	2-1/4	7/16	.449	37.32
000X6020	1-1/4	60	2-1/4	7/16	.449	37.32

Note - - Diameter B on all of the above is 2-1/4".

Note - - Diameter C on all of the above is 2".

Dealer Schedule.....203

**G&G**

**STANDARD KEYWAY SIZES**

Listed are the Standard Keyway Sizes furnished with the corresponding round bore sizes. These keyway sizes will be furnished with these round bore sizes unless a special keyway size is specified.

Bore	Keyway Size
1/2" to 9/16"	1/8"x1/16"
5/8" to 7/8"	3/16"x3/32"
15/16" to 1-1/4"	1/4"x1/8"
1-5/16" to 1-3/8"	5/16" x5/32"
1-7/16" to 1-3/4"	3/8"x3/16"
1-13/16" to 2-1/4"	1/2"x1/4"
2-5/16" to 2-3/4"	5/8"x5/16"
2-13/16" to 3"	3/4"x3/8"
3-5/16" to 3-3/4"	7/8"x7/16"
3-13/16" to 4-1/2"	1"x1/2"

**To Order Call Toll-Free:  
1-800-444-8666**

PRICES SUBJECT TO CHANGE WITHOUT NOTICE

NEW PRICES AS OF 12/4/2018



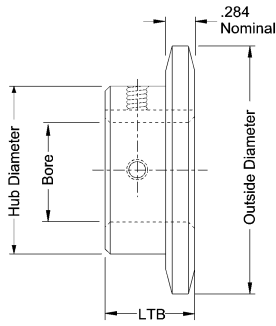

## TYPE B FINISH BORE ROLLER CHAIN SPROCKETS

with standard keyway and (2) set screws.

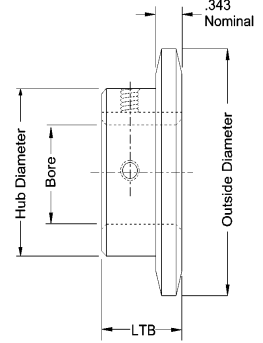

Sprockets come with (2) set screws @ 0° & 90°

Sprockets come with (2) set screws @ 0° & 90°

### #40 - 1/2" Pitch, Roller Width 5/16", Roller Diameter .312

### #50 - 5/8" Pitch, Roller Width 3/8", Roller Diameter .400

No.	Order	Hub	Hub					
Teeth	No.	Sprocket	Bore	O.D.	Dia.	LTB	Price	
12	604012105	.40B12*	5/8	2.166	1-9/16^	7/8	\$12.10	
12	604012125	.40B12*	3/4	2.166	1-9/16^	7/8	12.10	
12	604012145	.40B12*	7/8	2.166	1-9/16^	7/8	12.10	
12	604012165	.40B12*	1	2.166	1-9/16^	7/8	12.10	
13	604013085	.40B13*	1/2	2.166	1-9/16^	7/8	12.10	
13	604013105	.40B13*	5/8	2.329	1-9/16	7/8	12.10	
13	604013125	.40B13*	3/4	2.329	1-9/16	7/8	12.10	
13	604013165	.40B13*	1	2.329	1-9/16	7/8	12.10	
14	604014105	.40B14*	5/8	2.490	1-11/16	7/8	12.95	
14	604014125	.40B14*	3/4	2.491	1-11/16	7/8	12.95	
14	604014145	.40B14*	7/8	2.491	1-11/16	7/8	12.95	
14	604014165	.40B14*	1	2.491	1-11/16	7/8	12.95	
15	604015105	.40B15*	5/8	2.653	1-13/16	7/8	15.75	
15	604015125	.40B15*	3/4	2.653	1-13/16	7/8	15.75	
15	604015145	.40B15*	7/8	2.653	1-13/16	7/8	15.75	
15	604015165	.40B15*	1	2.653	1-13/16	7/8	15.75	
15	604015195	.40B15*	1-3/16	2.653	1-13/16	7/8	15.75	
16	604016105	.40B16*	5/8	2.814	2	7/8	16.60	
16	604016125	.40B16*	3/4	2.814	2	7/8	16.60	
16	604016145	.40B16*	7/8	2.814	2	7/8	16.60	
16	604016165	.40B16*	1	2.814	2	7/8	16.60	
16	604016185	.40B16*	1-1/8	2.814	2	7/8	16.60	
16	604016195	.40B16*	1-3/16	2.814	2	7/8	16.60	
16	604016205	.40B16*	1-1/4	2.814	2	7/8	16.60	
17	604017125	.40B17*	3/4	2.975	2-1/8	1	17.80	
17	604017145	.40B17*	7/8	2.975	2-1/8	1	17.80	
17	604017165	.40B17*	1	2.975	2-1/8	1	17.80	

No.	Order	Hub	Hub					
Teeth	No.	Sprocket	Bore	O.D.	Dia.	LTB	Price	
12	605012105	.50B12*	5/8	2.708	1-63/64^	1	\$17.05	
12	605012125	.50B12*	3/4	2.708	1-63/64^	1	17.05	
12	605012145	.50B12*	7/8	2.708	1-63/64^	1	17.05	
12	605012165	.50B12*	1	2.708	1-63/64^	1	17.05	
12	605012185	.50B12*	1-1/8	2.708	1-63/64^	1	17.05	
12	605012195	.50B12*	1-3/16	2.708	1-63/64^	1	17.05	
12	605012205	.50B12*	1-1/4	2.708	1-63/64^	1	17.05	
13	605013105	.50B13*	5/8	2.911	1-7/8^	1	18.05	
13	605013125	.50B13*	3/4	2.911	1-7/8^	1	18.05	
13	605013145	.50B13*	7/8	2.911	1-7/8^	1	18.05	
13	605013165	.50B13*	1	2.911	1-7/8^	1	18.05	
13	605013185	.50B13*	1-1/8	2.911	1-7/8^	1	18.05	
13	605013195	.50B13*	1-3/16	2.911	1-7/8^	1	18.05	
13	605013205	.50B13*	1-1/4	2.911	1-7/8^	1	18.05	
14	605014125	.50B14*	3/4	3.114	2-1/8	1	19.75	
14	605014145	.50B14*	7/8	3.114	2-1/8	1	19.75	
14	605014165	.50B14*	1	3.114	2-1/8	1	19.75	
14	605014185	.50B14*	1-1/8	3.114	2-1/8	1	19.75	
14	605014195	.50B14*	1-3/16	3.114	2-1/8	1	19.75	
14	605014205	.50B14*	1-1/4	3.114	2-1/8	1	19.75	
15	605015125	.50B15*	3/4	3.316	2-3/8	1	20.60	
15	605015145	.50B15*	7/8	3.316	2-3/8	1	20.60	
15	605015165	.50B15*	1	3.316	2-3/8	1	20.60	
15	605015185	.50B15*	1-1/8	3.316	2-3/8	1	20.60	
15	605015195	.50B15*	1-3/16	3.316	2-3/8	1	20.60	
15	605015205	.50B15*	1-1/4	3.316	2-3/8	1	20.60	
15	605015225	.50B15*	1-3/8	3.316	2-3/8	1	20.60	
15	605015245	.50B15*	1-1/2	3.316	2-3/8	1	20.60	
16	605016105	.50B16*	5/8	3.517	2-1/2	1	23.70	
16	605016125	.50B16*	3/4	3.517	2-1/2	1	23.70	
16	605016145	.50B16*	7/8	3.517	2-1/2	1	23.70	
16	605016165	.50B16*	1	3.517	2-1/2	1	23.70	
16	605016185	.50B16*	1-1/8	3.517	2-1/2	1	23.70	
16	605016195	.50B16*	1-3/16	3.517	2-1/2	1	23.70	
16	605016205	.50B16*	1-1/4	3.517	2-1/2	1	23.70	
16	605016225	.50B16*	1-3/8	3.517	2-1/2	1	23.70	
16	605016235	.50B16*	1-7/16	3.517	2-1/2	1	23.70	
16	605016245	.50B16*	1-1/2	3.517	2-1/2	1	23.70	
17	605017125	.50B17*	3/4	3.719	2-11/16	1	24.90	
17	605017145	.50B17*	7/8	3.719	2-11/16	1	24.90	
17	605017165	.50B17*	1	3.719	2-11/16	1	24.90	
17	605017185	.50B17*	1-1/8	3.719	2-11/16	1	24.90	
17	605017195	.50B17*	1-3/16	3.719	2-11/16	1	24.90	
17	605017205	.50B17*	1-1/4	3.719	2-11/16	1	24.90	
17	605017235	.50B17*	1-7/16	3.719	2-11/16	1	24.90	
17	605017245	.50B17*	1-1/2	3.719	2-11/16	1	24.90	
18	605018125	.50B18*	3/4	3.919	2-7/8	1	26.30	
18	605018145	.50B18*	7/8	3.919	2-7/8	1	26.30	
18	605018165	.50B18*	1	3.919	2-7/8	1	26.30	
18	605018185	.50B18*	1-1/8	3.919	2-7/8	1	26.30	
18	605018195	.50B18*	1-3/16	3.919	2-7/8	1	26.30	
18	605018205	.50B18*	1-1/4	3.919	2-7/8	1	26.30	
18	605018235	.50B18*	1-7/16	3.919	2-7/8	1	26.30	
18	605018245	.50B18*	1-1/2	3.919	2-7/8	1	26.30	
19	605019165	.50B19*	1	4.121	3	1	27.30	
19	605019205	.50B19*	1-1/4	4.121	3	1	27.30	

Finished Bore Sprockets Continued on Next Page.

**NEW PRICES AS OF 12/1/2018**

Material: 1045

Keyway timed with centerline of tooth

\* Teeth hardened to 30-45 Rc

^ Has recessed groove in hub for chain clearance.

Dealer Schedule.....203

For other sizes of finished bore sprockets not shown,  
call Central Supply for price and availability.

**We Ship  
Over 95%  
Of Our Orders  
The Same Day!**

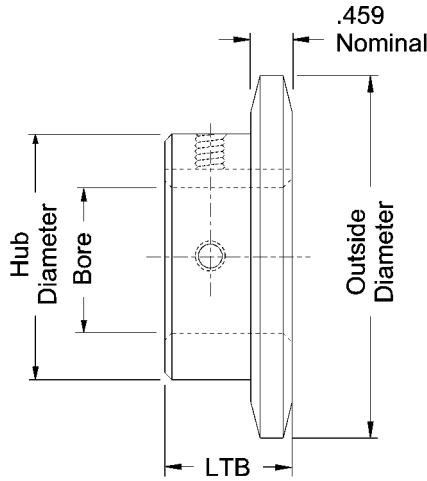

# TYPE B FINISH BORE ROLLER CHAIN SPROCKETS

with standard keyway and (2) set screws.



**#60**

3/4" Pitch, Roller Width 1/2", Roller Diameter .469

Sprockets come with (2) set screws @ 0° & 90°

No. Teeth	Order No.	Sprocket	Bore	O.D.	Hub Dia.	Hub LTB	Price
12	606012145	.60B12*	7/8	3.249	2-3/8^	1-1/4	\$22.10
12	606012165	.60B12*	1	3.249	2-3/8^	1-1/4	22.10
12	606012185	.60B12*	1-1/8	3.249	2-3/8^	1-1/4	22.10
12	606012195	.60B12*	1-3/16	3.249	2-3/8^	1-1/4	22.10
12	606012205	.60B12*	1-1/4	3.249	2-3/8^	1-1/4	22.10
13	606013125	.60B13*	3/4	3.493	2-1/4	1-1/4	26.40
13	606013145	.60B13*	7/8	3.493	2-1/4	1-1/4	26.40
13	606013165	.60B13*	1	3.493	2-1/4	1-1/4	26.40
13	606013185	.60B13*	1-1/8	3.493	2-1/4	1-1/4	26.40
13	606013195	.60B13*	1-3/16	3.493	2-1/4	1-1/4	26.40
13	606013205	.60B13*	1-1/4	3.493	2-1/4	1-1/4	26.40
13	606013225	.60B13*	1-3/8	3.493	2-1/4	1-1/4	26.40
13	606013235	.60B13*	1-7/16	3.493	2-1/4	1-1/4	26.40
13	606013245	.60B13*	1-1/2	3.493	2-1/4	1-1/4	26.40
14	606014145	.60B14*	7/8	3.736	2-9/16	1-1/4	26.75
14	606014165	.60B14*	1	3.736	2-9/16	1-1/4	26.75
14	606014185	.60B14*	1-1/8	3.736	2-9/16	1-1/4	26.75
14	606014205	.60B14*	1-1/4	3.736	2-9/16	1-1/4	26.75
14	606014225	.60B14*	1-3/8	3.736	2-9/16	1-1/4	26.75
14	606014235	.60B14*	1-7/16	3.736	2-9/16	1-1/4	26.75
14	606014245	.60B14*	1-1/2	3.736	2-9/16	1-1/4	26.75
15	606015145	.60B15*	7/8	3.979	2-5/8	1-1/4	27.10
15	606015165	.60B15*	1	3.979	2-5/8	1-1/4	27.10
15	606015185	.60B15*	1-1/8	3.979	2-5/8	1-1/4	27.10
15	606015205	.60B15*	1-1/4	3.979	2-5/8	1-1/4	27.10

No. Teeth	Order No.	Sprocket	Bore	O.D.	Hub Dia.	Hub LTB	Price
15	606015225	.60B15*	1-3/8	3.979	2-5/8	1-1/4	\$27.10
15	606015235	.60B15*	1-7/16	3.979	2-5/8	1-1/4	27.10
15	606015245	.60B15*	1-1/2	3.979	2-5/8	1-1/4	27.10
15	606015265	.60B15*	1-5/8	3.979	2-5/8	1-1/4	27.10
15	606015285	.60B15*	1-3/4	3.979	2-5/8	1-1/4	27.10
16	606016145	.60B16*	7/8	4.220	3-1/16	1-1/4	28.30
16	606016165	.60B16*	1	4.220	3-1/16	1-1/4	28.30
16	606016185	.60B16*	1-1/8	4.220	3-1/16	1-1/4	28.30
16	606016195	.60B16*	1-3/16	4.220	3-1/16	1-1/4	28.30
16	606016205	.60B16*	1-1/4	4.220	3-1/16	1-1/4	28.30
16	606016245	.60B16*	1-1/2	4.220	3-1/16	1-1/4	28.30
16	606016285	.60B16*	1-3/4	4.220	3-1/16	1-1/4	28.30
17	606017165	.60B17*	1	4.463	3-1/4	1-1/4	30.15
17	606017185	.60B17*	1-1/8	4.463	3-1/4	1-1/4	30.15
17	606017205	.60B17*	1-1/4	4.463	3-1/4	1-1/4	30.15
17	606017225	.60B17*	1-3/8	4.463	3-1/4	1-1/4	30.15
17	606017235	.60B17*	1-7/16	4.463	3-1/4	1-1/4	30.15
17	606017245	.60B17*	1-1/2	4.463	3-1/4	1-1/4	30.15
17	606017315	.60B17*	1-15/16	4.463	3-1/4	1-1/4	30.15
18	606018165	.60B18*	1	4.703	3-1/2	1-1/4	30.80
18	606018185	.60B18*	1-1/8	4.703	3-1/2	1-1/4	30.80
18	606018195	.60B18*	1-3/16	4.703	3-1/2	1-1/4	30.80
18	606018205	.60B18*	1-1/4	4.703	3-1/2	1-1/4	30.80
18	606018225	.60B18*	1-3/8	4.703	3-1/2	1-1/4	30.80
18	606018235	.60B18*	1-7/16	4.703	3-1/2	1-1/4	30.80
18	606018245	.60B18*	1-1/2	4.703	3-1/2	1-1/4	30.80
18	606018265	.60B18*	1-5/8	4.703	3-1/2	1-1/4	30.80
18	606018285	.60B18*	1-3/4	4.703	3-1/2	1-1/4	30.80

Material: 1045

Keyway timed with centerline of tooth

\* Teeth hardened to 30-45 Rc

^ Has recessed groove in hub for chain clearance.

Dealer Schedule.....203

For sizes of finished bore sprockets not shown, call Central Supply for price and availability.

**Fax Toll-Free  
1-800-342-7252**



PRICES ARE SUBJECT TO CHANGE WITHOUT NOTICE.



### IDLER SPROCKETS (Furnished With Hardened Teeth)

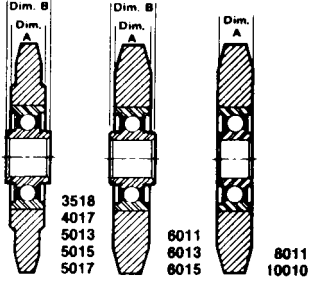
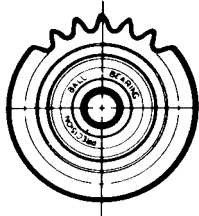

Order No.	Chain Size	No. of Teeth	Bore	Dia. A	Dia. B	Price
03518E08	35	18	1/2	7/16	11/16	\$17.74
03518E10	35	18	5/8	7/16	11/16	17.74
04017E08	40 or 41	17	1/2	7/16	11/16	18.84
04017E10	40 or 41	17	5/8	7/16	11/16	18.84
05013E08	50	13	1/2	7/16	11/16	26.02
05013E10	50	13	5/8	7/16	11/16	26.02
05015E08	50	15	1/2	7/16	11/16	21.28
05015E10	50	15	5/8	7/16	11/16	21.28
05017E08	50	17	1/2	7/16	11/16	23.60
05017E10	50	17	5/8	7/16	11/16	23.60
06011E08	60	11	1/2	7/16	11/16	22.46
06011E10	60	11	5/8	7/16	11/16	22.46
06013E08	60	13	1/2	7/16	11/16	23.60
06013E10	60	13	5/8	7/16	11/16	23.60
06015E08	60	15	1/2	7/16	11/16	25.74
06015E10	60	15	5/8	7/16	11/16	25.74
08011012	80	11	3/4	9/16		33.80
08012012	80	12	3/4	9/16		51.12
10010016	100	10	1	11/16		80.20

Dealer Schedule.....203

**Centralize  
with  
Central Supply!**

01008E11	Reducer Bushing, 5/8" O.D. x 1/2" I.D. f/Idler Bearing	2.09
02211E08	1/2" Bearing only f/G&G Idler	20.22
02211E10	5/8" Bearing only f/G&G Idler	20.22
03209012	3/4" Bearing only f/G&G Idler	37.79

Dealer Schedule.....102

NEW PRICES AS OF 12/4/2018

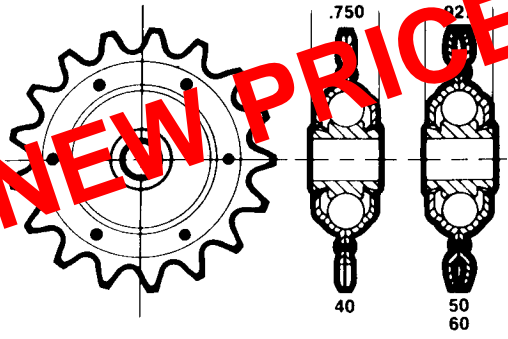

### STAMPED IDLER SPROCKETS (Furnished With Hardened Teeth)

Order No.	Chain Size	No. of Teeth	Bore	Aetna No.	Price
033-4018	40 or 41	18	1/2	AG-2318-A	\$20.52
034-4018	40 or 41	18	5/8	AG-2318	20.52
033-5017	50	17	1/2	AG-2416-A	24.31
034-5017	50	17	5/8	AG-2416	24.31
033-6015	60	15	1/2	AG-2417-A	23.67
034-6015	60	15	5/8	AG-2417	23.67
034-8550	550	8	5/8	AG-2566-2AF	60.07

Dealer Schedule.....203

## G & G Idler Weld-A-Hubs

W & X Series

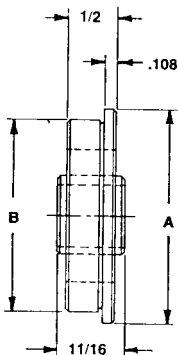
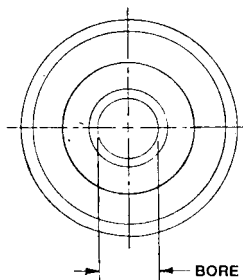

For a quick idler application: Pick the appropriate sprocket or pulley and then pick the corresponding idler hub. For both W or X weldasprockets and weldapulleys. Idler hubs available in 5/8" I.D. bores. Packaged with 1/2" I.D. reducer bushing. Same precision ball bearing used on idler sprockets. Idler hubs machined to eliminate special fixtures. Simply clamp idler hub to sprocket or pulley and weld.

Order No.	Series	A	B	Price
00023010	W	1-13/16	1-5/8	\$31.61
00033010	X	2-1/4	2	35.89

Dealer Schedule.....203

# Aetna Idler Sprockets

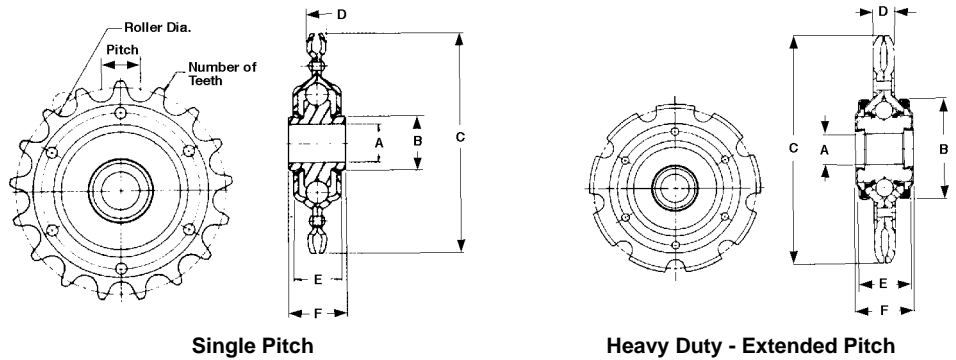

### Aetna - Heavy Duty - Extended Pitch Idler Sprockets (For Cornheads)

Order No.	Chain No.	Pitch	Roller Dia.	Teeth	A	B	C	D	E	F	List
AG-2427	2060	1-1/2	15/32	8	.643/.649	7/8	4-7/32	7/16	27/32	.927	\$28.25
AG-2427-1AF	2060	1-1/2	15/32	8	.643/.649	2-5/64	4-7/32	7/16	31/32	31/32	27.36
AG-2438-1AF	Special	1-1/4	.460	11	.643/.649	2-5/64	4-17/32	9/16	1-1/32	1-1/32	45.50
AG-2565-2AF	555	1.630	21/32	8	.643/.649	2-5/64	4-3/4	7/16	1-1/16	1-3/16	29.15
AG-2565-3AF	555	1.630	21/32	8	.643/.649	2-5/64	4-3/4	7/16	31/32	31/32	30.51
AG-2566-2AF	550	1.630	21/32	8	.643/.649	2-5/64	4-3/4	11/16	1-1/16	1-3/16	29.49
AG-2566-4AF	550	1.630	21/32	8	.630/.636	2-5/64	4-3/4	11/16	1-1/32	1-1/32	43.16

### Aetna - Single Pitch Idler Sprockets

Order No.	Chain No.	Pitch	Roller Dia.	Teeth	A	B	C	D	E	F	List
AG-2318-S	40 or 41	1/2	.312, .306	18	5/8	1	3-1/16	15/64	45/64	.750	\$20.52
AG-2318-A	40 or 41	1/2	.312, .306	18	1/2	1	3-1/16	15/64	45/64	.750	20.52
AG-2416	50	5/8	.400	17	5/8	7/8	3-5/8	11/32	51/64	.927	24.31
AG-2416-A	50	5/8	.400	17	1/2	7/8	3-5/8	11/32	51/64	.927	24.31
AG-2416-AP	50	5/8	.400	17	1/2	7/8	3-5/8	11/32	51/64	1-1/8	26.50
AG-2436-A*	50	5/8	.400	17	1/2	7/8	3-5/8	11/32	27/32	.927	29.65
AG-2417	60	3/4	15/32	15	5/8	7/8	3-29/32	7/16	53/64	.927	23.67
AG-2417-A	60	3/4	15/32	15	1/2	7/8	3-29/32	7/16	53/64	.927	23.67
AG-2437*	60	3/4	15/32	15	5/8	7/8	3-29/32	7/16	27/32	.927	23.52
AG-2437-A*	60	3/4	15/32	15	1/2	7/8	3-29/32	7/16	27/32	.927	24.70

\* Extra Heavy Gauge Steel

Dealer Schedule.....203

### AETNA SPROCKET CROSS REFERENCE TABLE

Aetna No.	John Deere	J.I. Case	Ford/N-H	White	Massey	Allis	Other
AG-2427	AN10496N	820290C91	00513327				Bush Hog 450189
AG-2427-1AF					267526M1/844076N1		
AG-2438-1AF	AH103303						
AG-2565-2AF	AN102448	176283C91	00573399				Farmhand IA60520
AG-2565-3AF	AH101219						
AG-2566-2AF				745023		70595084	
AG-2566-4AF						71359125	
AG-2318-S	AH16773	47977	00103243		833492M1	47977	Gehl 023934
AG-2318-A		607779R91		853265	834596M1	564148	Farmhand 7187-3
AG-2416	L2231C	631905R91	00103244		833491M1	854076	Farmhand 7187-2
AG-2416-A	AN10225	565442R91	00216850			47142	Gehl D9130, Farmhand 7187-4
AG-2416-AP	AH21440						
AG-2417	L2285C	582389R91					
		101616C92					
		H74386	00511265	W8950276	832103M1	47159	Farmhand 7187-1
AG-2417-A		571441R91	00050985		833494M1	847608	Gehl H7812, Vermeer 1813-001-1
AG-2436-A		7087398		31-2555620		7087398	
AG-2437	AN15521	629972R91				7085970	
AG-2437-A			00165271				

ALL PRICES SUBJECT TO CHANGE WITHOUT NOTICE.

**Call Central Supply Toll-Free 1-800-444-8666**

# Aetna Belt Idlers

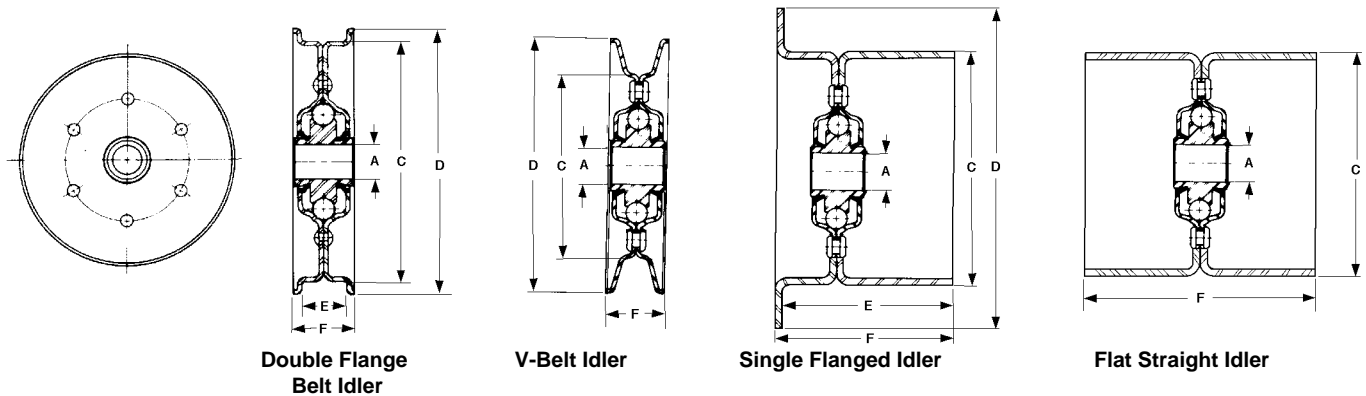

Order No.	Description	Type Belt	A	C	D	E	F	Price
AG2321	V-Belt Idler	A	634/.649	2-1/4"	3-1/4"		7/8"	25.58
AG2352	Double Flange Idler	Any	643/.649	2-7/8"	3-1/4"	11/16"	27/32"	24.52
AG2365-A	Single Flange Idler	Any	516/.522	2-3/4"	3-1/2"	1-1/2"	1-11/16"	27.50
AG2367-A	Flat Straight Idler	Any	516/.522	2-3/4"			1-1/2"	29.30
AG2613	Double Flange Idler	Any	643/.649	6"	7"	1"	1-3/8"	33.67
B13516-A	V-Belt Idler	B	510/.515		4-3/8"		1"	39.70
F16424-B	Double Flange Idler	Any	635/.640	8"	9"	1-1/2"	1-15/16"	65.15
F24032-AJD	Double Flange Idler (2-Row Bearing)	Any	516/.522	5"	5-1/2"	2"	2-3/16"	72.55
F26424-BJD	Double Flange Idler (2-Row Bearing)	Any	516/.522	8"	8-3/4"	1-1/2"	1-11/16"	67.60
S25252-C	Flat Straight Idler	Any	769/.775	6-1/2"			3-1/4"	96.70
S26452-AJD	Flat Straight Idler (2-Row Bearing)	Any	516/.522	8"			3-1/4"	110.50

## AETNA IDLER PULLEY CROSS REFERENCE TABLE

Aetna No.	John Deere	J.I. Case	Ford/N-H	Massey	White	Allis	Other
AG2365-A						71160426, 54478	
AG2367-A						71358077, 79008328, 70535928	
AG2613	AP245354	570265R91	00127645		W9863420		Gehl 1053688, Vermeer 2304 001
B13516-A		1315269C1					
F16324-B	AN30569					8533044	
F24032-AJD	AH96292						
F26424-BJD	AH94450	222100C1					
S25252-C	AE28573						Farmhand 7615-3
S26452-AJD	AH87119, AH93318						Gehl 09912/

## Aetna Adapter Bearings

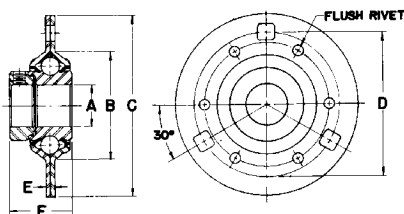

AETNA Adapter Bearings are a series of mounted ball bearing units designed for use in equipment where shafts are supported in frames or sheet metal surfaces. Typical applications include overhead doors, conveyor systems, grain augers, and other agricultural equipment. They provide a combination of features which literally give them universal adaptability; hence the name Adapter Bearing. Combining a self-aligning bearing, seals, a mounting flange, and shaft locking device in a single compact pre-lubricated installation, without further time consuming assembling or adjustment.

Order No.	A	B	C	D	E	F	List
AG1012-S	3/4	2-3/8	3-3/4	3	3/16	1-1/4	\$38.80
AG1014-S	7/8	2-3/8	3-3/4	3	3/16	1-1/4	40.65
AG1102-S	1-1/8	2-13/16	4-7/16	3-9/16	1/4	1-1/4	61.00
AG1103	1-3/16	2-13/16	4-7/16	3-9/16	1/4	1-1/4	61.00
AG1106-B	1-3/8	3-1/2	6-1/2	4-11/16	5/16	2-5/8	49.16
AG1108-B	1-1/2	3-1/2	6-1/2	4-11/16	5/16	2-5/8	52.72

**V-GROOVE PULLEY BLANKS**

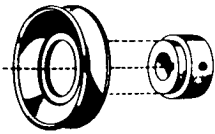

Single Groove For "A" and "B" Series Belts.

Order No.	Hub Series	O.D.	Price
00710025	V	1-1/2	\$12.20
00710030	V	3	16.14
00720035	W	3-1/2	6.40
00720040	W	4	7.05
00720045	W	4-1/2	7.75
00720050	W	5	8.05
00720055	W	5-1/2	9.35
00720060	W	6	11.20
00720065	W	6-1/2	11.40
00720070	W	7	12.65
00720080	W	8	17.40
00720090	W	9	20.95
00720100	W	10	25.50
00720110	W	11	30.20
00720120	W	12	34.85
00720140	W	14	45.10
00720160	W	16	56.75

Single Groove For "C" Series Belts.

Order No.	Hub Series	O.D.	Price
00740060	X	6	\$24.54
00740080	X	8	34.78
00740100	X	10	43.34
00740120	X	12	65.10

Dealer Schedule.....203

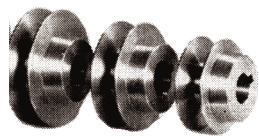

**Cast Steel V-Pulleys**  
Single Groove

**"A" GROOVE PULLEYS**

Fits "2000" & "4L" Series V-Belts

Number	O.D.	Bore	Price
7800-0006	1-3/4	1/2	\$10.15
7800-0007	1-3/4	5/8	10.15
7800-0008	1-3/4	3/4	10.15
7800-0011	2	1/2	11.35
7800-0012	2	5/8	11.35
7800-0013	2	3/4	11.35
7800-0016	2-1/4	1/2	12.10
7800-0017	2-1/4	5/8	12.10
7800-0018	2-1/4	3/4	12.10
7800-0043	3-1/2	1	14.26

**"B" GROOVE PULLEYS**

Fits "3000" & "5L" V-Belts

Number	O.D.	Bore	Price
7800-0066	2-1/4	1/2	\$14.60
7800-0067	2-1/4	5/8	14.60
7800-0068	2-1/4	3/4	14.60

Dealer Schedule.....203



**V-BELT IDLER PULLEYS**



Single Groove For "A" and "B" Series Belts.

Order No.	O.D.	Bore	Price
011-8008	5	1/2	\$27.07
011-8010	5	5/8	27.07

Dealer Schedule.....203

**FLAT BELT IDLER PULLEYS**

Order No.	O.D.	Bore	Price
011-4408	2-3/4"	1/2"	\$25.00
011-4410	2-3/4"	5/8"	25.00
011-6408	4"	1/2"	27.07
011-6410	4"	5/8"	27.07

Dealer Schedule.....203

**Double Pulley Weld-A-Hubs**

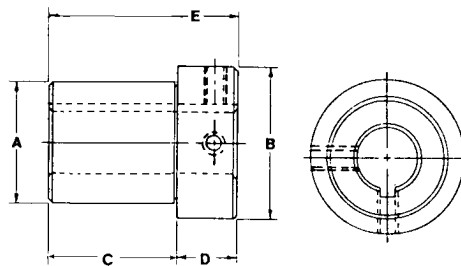

Designed to eliminate any special fixtures for pulley alignment and positioning.

**Assembly in 3 easy steps**

1. Clamp one pulley flush against the shoulder of the Double Pulley Hub and weld both together.
2. Slide the second pulley into the 1-5/8" diameter step.
3. Clamp so that it is tight against the first pulley and weld the pulley to the hub on the 1-5/8" diameter step.

Dimensions				
A	B	C	D	E
1-5/8"	1-13/16"	1-5/16"	1"	2-5/16"

Order No.	Bore	KW	Set Screws	Price
DPH0075	3/4"	3/16"x3/32"	1/4"-20	\$11.50
DPH0875	7/8"	3/16"x3/32"	1/4"-20	11.50
DPH1000	1"	1/4"x1/8"	5/16"-18	11.50
DPH1125	1-1/8"	1/4"x1/8"	5/16"-18	11.50
DPH1250	1-1/4"	1/4"x1/8"	5/16"-18	11.50

Dealer Schedule.....203

# Solid Steel V-Pulleys

AB Belt Type A Pulleys are furnished with standard keyway and (2) set screws.

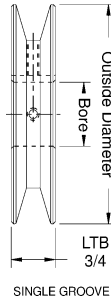

SINGLE GROOVE

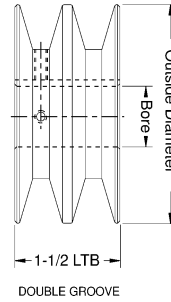

DOUBLE GROOVE

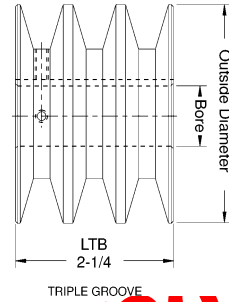

TRIPLE GROOVE

## SINGLE GROOVE PULLEYS

Stock No.	Outside Dia. In.	Bore Size In.	Price
041-4008	2-1/2	1/2	\$10.10
041-4010	2-1/2	5/8	10.10
041-4012*	2-1/2	3/4	10.10
041-4014	2-1/2	7/8	10.10
041-4016*	2-1/2	1	10.10
041-4408	2-3/4	1/2	12.05
041-4410	2-3/4	5/8	12.05
041-4412	2-3/4	3/4	12.05
041-4414	2-3/4	7/8	12.05
041-4416*	2-3/4	1	12.05
041-4418*	2-3/4	1-1/8	12.05
041-4808	3	1/2	13.85
041-4810	3	5/8	13.85
041-4812	3	3/4	13.85
041-4814	3	7/8	13.85
041-4816	3	1	13.85
041-4818	3	1-1/8	13.85
041-5208	3-1/4	1/2	15.55
041-5210	3-1/4	5/8	15.55
041-5212	3-1/4	3/4	15.55
041-5214	3-1/4	7/8	15.55
041-5216	3-1/4	1	15.55
041-5218	3-1/4	1-1/8	15.55

## DOUBLE GROOVE PULLEYS

Stock No.	Outside Dia. In.	Bore Size In.	Price
041-5608	3-1/2	1/2	\$17.70
041-5610	3-1/2	5/8	17.70
041-5612	3-1/2	3/4	17.70
041-5614	3-1/2	7/8	17.70
041-5616	3-1/2	1	17.70
041-5618	3-1/2	1-1/8	17.70
041-6008	3-3/4	1/2	19.40
041-6010	3-3/4	5/8	19.40
041-6012	3-3/4	3/4	19.40
041-6014	3-3/4	7/8	19.40
041-6016	3-3/4	1	19.40
041-6018	3-3/4	1-1/8	19.40
041-6408	4	1/2	21.10
041-6410	4	5/8	21.10
041-6412	4	3/4	21.10
041-6414	4	7/8	21.10
041-6416	4	1	21.10
041-6418	4	1-1/8	21.10
041-6814	4-1/4	7/8	23.40
041-6816	4-1/4	1	23.40
041-6818	4-1/4	1-1/8	23.40
041-7216	4-1/2	1	26.95
041-7218	4-1/2	1-1/8	26.95

NEW PRICES AS OF 12/4/2018

## TRIPLE GROOVE PULLEYS

Stock No.	Outside Dia. In.	Bore Size In.	Price
042-4810	3	5/8	\$21.15
042-4814	3	7/8	21.15
042-4818	3	1-1/8	21.15
042-4822*	3	1-3/8	21.15
042-5218	3-1/4	1-1/8	22.55
042-5222*	3-1/4	1-3/8	22.55
042-5618	3-1/2	1-1/8	24.80
042-5622	3-1/2	1-3/8	24.80

\* Set Screws are @ 90° & 180° to Keyway

Dealer Schedule.....203

**Centralize**  
your parts orders with  
**Central Supply**

Call Us Toll-Free:

**1-800-444-8666**

## Sprayon Belt Dressing



Will not glaze or collect dirt and dust. Contains no resin or asphalt. Cleans away residual build-up of foreign materials. Performs effectively in wet, outdoor conditions. Spray from any position. Can be applied directly to belts while running or directly to sheaves of wheels.

APPLICATIONS: Leather, rubber, canvas, fabric, flat, round or "V" belts, auto fan belt, farm machinery belting, all industrial belt drives.

No. 00607 ..... Belt Dressing, 11 oz., Pressurized ..... Each \$10.10

Dealer Schedule: (Case of 12) ..... 253  
(Broken Case)..... 102

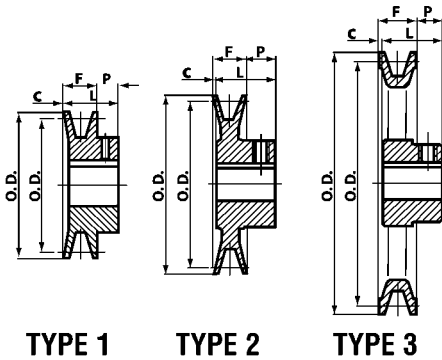

# Cast Iron Sheaves

**Single Groove Sheaves**  
For "4L" & "5L", "A" & "B" V-Belts

- Type 1 ----- Solid Steel
- Type 2 ----- Solid Cast Iron
- Type 3 ----- Cast Iron Spoked



Stock No.	Type	O.D.	Bore	Price
BK024-08 ... 1 ...	1	2.40"	1/2"	\$7.32
BK024-10 ... 1 ...	1	2.40"	5/8"	7.32
BK024-12 ... 1 ...	1	2.40"	3/4"	7.32
BK024-14 ... 1 ...	1	2.40"	7/8"	7.32
BK025-08 ... 1 ...	1	2.50"	1/2"	8.75
BK025-10 ... 1 ...	1	2.50"	5/8"	8.75
BK025-12 ... 1 ...	1	2.50"	3/4"	8.75
BK025-14 ... 1 ...	1	2.50"	7/8"	8.75
BK026-08 ... 1 ...	1	2.60"	1/2"	9.48
BK026-10 ... 1 ...	1	2.60"	5/8"	9.48
BK026-12 ... 1 ...	1	2.60"	3/4"	9.48
BK026-14 ... 1 ...	1	2.60"	7/8"	9.48
BK027-08 ... 2 ...	2	2.70"	1/2"	10.18
BK027-10 ... 2 ...	2	2.70"	5/8"	10.18
BK027-12 ... 2 ...	2	2.70"	3/4"	10.18
BK027-14 ... 2 ...	2	2.70"	7/8"	10.18
BK027-18 ... 2 ...	2	2.70"	1-1/8"	10.18
BK028-08 ... 2 ...	2	2.95"	1/2"	10.91
BK028-10 ... 2 ...	2	2.95"	5/8"	10.91
BK028-12 ... 2 ...	2	2.95"	3/4"	10.91
BK028-14 ... 2 ...	2	2.95"	7/8"	10.91
BK028-16 ... 2 ...	2	2.95"	1"	10.91
BK028-18 ... 2 ...	2	2.95"	1-1/8"	10.91

Stock No.	Type	O.D.	Bore	Price
BK030-08 ... 2 ...	2	3.15"	1/2"	\$11.06
BK030-10 ... 2 ...	2	3.15"	5/8"	11.06
BK030-12 ... 2 ...	2	3.15"	3/4"	11.06
BK030-14 ... 2 ...	2	3.15"	7/8"	11.06
BK030-16 ... 2 ...	2	3.15"	1"	11.06
BK030-18 ... 2 ...	2	3.15"	1-1/8"	11.06
BK032-08 ... 2 ...	2	3.35"	1/2"	11.84
BK032-10 ... 2 ...	2	3.35"	5/8"	11.84
BK032-12 ... 2 ...	2	3.35"	3/4"	11.84
BK032-14 ... 2 ...	2	3.35"	7/8"	11.84
BK032-16 ... 2 ...	2	3.35"	1"	11.84
BK034-08 ... 2 ...	2	3.55"	1/2"	13.22
BK034-10 ... 2 ...	2	3.55"	5/8"	13.22
BK034-12 ... 2 ...	2	3.55"	3/4"	13.22
BK034-14 ... 2 ...	2	3.55"	7/8"	13.22
BK034-16 ... 2 ...	2	3.55"	1"	13.22
BK034-18 ... 2 ...	2	3.55"	1-1/8"	13.22
BK036-08 ... 2 ...	2	3.75"	1/2"	14.65
BK036-10 ... 2 ...	2	3.75"	5/8"	14.65
BK036-12 ... 2 ...	2	3.75"	3/4"	14.65
BK036-14 ... 2 ...	2	3.75"	7/8"	14.65
BK036-16 ... 2 ...	2	3.75"	1"	14.65
BK036-18 ... 2 ...	2	3.75"	1-1/8"	14.65

Stock No.	Type	O.D.	Bore	Price
BK040-08 ... 2 ...	2	3.95"	1/2"	\$16.16
BK040-10 ... 2 ...	2	3.95"	5/8"	16.16
BK040-12 ... 2 ...	2	3.95"	3/4"	16.16
BK040-14 ... 2 ...	2	3.95"	7/8"	16.16
BK040-16 ... 2 ...	2	3.95"	1"	16.16
BK040-18 ... 2 ...	2	3.95"	1-1/8"	16.16
BK045-08 ... 2 ...	2	4.25"	1/2"	17.56
BK045-10 ... 2 ...	2	4.25"	5/8"	17.56
BK045-12 ... 2 ...	2	4.25"	3/4"	17.56
BK045-14 ... 2 ...	2	4.25"	7/8"	17.56
BK045-16 ... 2 ...	2	4.25"	1"	17.56
BK045-18 ... 2 ...	2	4.25"	1-1/8"	17.56
BK047-08 ... 2 ...	2	4.45"	1/2"	17.90
BK047-10 ... 2 ...	2	4.45"	5/8"	17.90
BK047-12 ... 2 ...	2	4.45"	3/4"	17.90
BK047-14 ... 2 ...	2	4.45"	7/8"	17.90
BK047-16 ... 2 ...	2	4.45"	1"	17.90
BK047-18 ... 2 ...	2	4.45"	1-1/8"	17.90
BK050-08 ... 3 ...	3	4.75"	1/2"	18.52
BK050-10 ... 3 ...	3	4.75"	5/8"	18.52
BK050-12 ... 3 ...	3	4.75"	3/4"	18.52
BK050-14 ... 3 ...	3	4.75"	7/8"	18.52
BK050-16 ... 3 ...	3	4.75"	1"	18.52
BK050-18 ... 3 ...	3	4.75"	1-1/8"	18.52

All of the above sizes are normally stocked at our Omaha location.

Sizes listed below are non-stock but may be shipped direct. Available bore sizes are marked with their size number suffix.

P.N.	Type	O.D.	1/2"	5/8"	3/4"	7/8"	1"	1-1/8"	1-3/16"	1-1/4"	1-3/8"	1-7/16"	Retail
BK052 ... 3	3	4.95"	-08	-10	-12	-14	-16	-18					\$18.83
BK055 ... 3	3	5.25"	-08	-10	-12	-14	-16	-18	-19				20.05
BK057 ... 3	3	5.45"		-10	-12	-14	-16	-18					20.13
BK060 ... 3	3	5.75"	-08	-10	-12	-14	-16	-18	-19				21.56
BK062 ... 3	3	5.95"	-08	-10	-12	-14	-16	-18	-19				22.83
BK065 ... 3	3	6.25"		-10	-12		-16	-18					24.39
BK067 ... 3	3	6.45"		-10	-12		-16	-18					25.74
BK070 ... 3	3	6.75"		-10	-12		-16	-18	-19			-23	26.08
BK072 ... 3	3	6.95"			-12		-16	-18			-22	-23	27.38
BK075 ... 3	3	7.25"			-12		-16	-18				-23	30.18
BK077 ... 3	3	7.45"			-12		-16	-18			-22	-23	31.71
BK080 ... 3	3	7.75"		-10	-12	-14	-16	-18	-19	-20	-22	-23	33.22
BK085 ... 3	3	8.25"			-12		-16	-18	-19		-22	-23	36.13
BK090 ... 3	3	8.75"			-12	-14	-16	-18	-19		-22	-23	38.29
BK095 ... 3	3	9.25"			-12		-16	-18			-22	-23	39.95
BK100 ... 3	3	9.75"			-12	-14	-16	-18	-19	-20	-22	-23	44.29
BK105 ... 3	3	10.25"					-16				-22	-23	47.40
BK110 ... 3	3	10.75"			-12		-16	-18	-19		-22	-23	51.92
BK115 ... 3	3	11.25"					-16				-22	-23	56.18
BK120 ... 3	3	11.75"			-12		-16		-19		-22	-23	59.30
BK130 ... 3	3	12.75"			-12		-16	-18	-19			-23	66.34
BK140 ... 3	3	13.75"			-12		-16		-19			-23	73.58
BK160 ... 3	3	15.75"					-16	-18	-19	-20		-23	83.61
BK190 ... 3	3	18.75"					-16		-19	-20		-23	88.39





# Cast Iron Sheaves

**Double Groove Sheaves**  
For "4L" & "5L", "A" & "B" V-Belts

- Type 1 ----- Solid Steel
- Type 2 ----- Solid Cast Iron
- Type 3 ----- Cast Iron Spoked

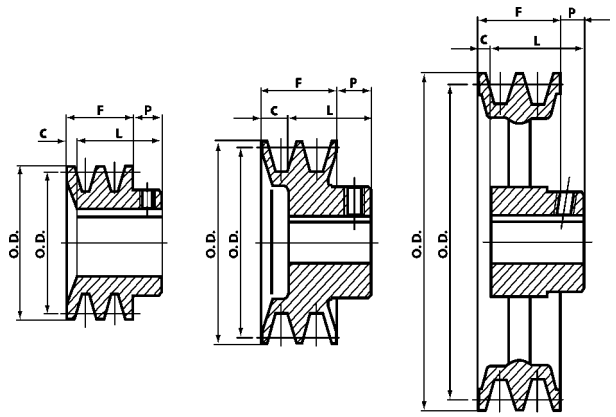

**TYPE 1**

**TYPE 2**

**TYPE 3**

Stock No.	Type	O.D.	Bore	Price
2BK025-08 ..1 ...		2.50" ....	1/2" ..	\$14.08
2BK025-10 ..1 ...		2.50" ....	5/8" ....	14.08
2BK025-12 ..1 ...		2.50" ....	3/4" ....	14.08
2BK025-14 ..1 ...		2.50" ....	7/8" ....	14.08
2BK027-08 ..1 ...		2.70" ....	1/2" ....	16.34
2BK027-10 ..1 ...		2.70" ....	5/8" ....	16.34
2BK027-12 ..1 ...		2.70" ....	3/4" ....	16.34
2BK027-14 ..1 ...		2.70" ....	7/8" ....	16.34
2BK027-16 ..1 ...		2.70" ....	1" .....	16.34
2BK028-08 ..1 ...		2.95" ....	1/2" ....	17.53
2BK028-10 ..1 ...		2.95" ....	5/8" ....	17.53
2BK028-12 ..1 ...		2.95" ....	3/4" ....	17.53
2BK028-14 ..1 ...		2.95" ....	7/8" ....	17.53
2BK028-16 ..1 ...		2.95" ....	1" .....	17.53
2BK028-18 ..1 ...		2.95" ..	1-1/8" ..	17.53
2BK030-08 ..1 ...		3.15" ....	1/2" ....	17.77
2BK030-10 ..1 ...		3.15" ....	5/8" ....	17.77

Stock No.	Type	O.D.	Bore	Price
2BK030-12 ..1 ...		3.15" ....	3/4" ..	\$17.77
2BK030-14 ..1 ...		3.15" ....	7/8" ....	17.77
2BK030-16 ..1 ...		3.15" ....	1" .....	17.77
2BK030-18 ..1 ...		3.15" ..	1-1/8" ..	17.77
2BK032-10 ..1 ...		3.35" ....	5/8" ....	18.83
2BK032-14 ..1 ...		3.35" ....	7/8" ....	18.83
2BK032-16 ..1 ...		3.35" ....	1" .....	18.83
2BK032-18 ..1 ...		3.35" ..	1-1/8" ..	18.83
2BK034-10 ..1 ...		3.55" ....	5/8" ....	20.88
2BK034-12 ..1 ...		3.55" ....	3/4" ....	20.88
2BK034-14 ..1 ...		3.55" ....	7/8" ....	20.88
2BK034-16 ..1 ...		3.55" ....	1" .....	20.88
2BK034-18 ..1 ...		3.55" ..	1-1/8" ..	20.88
2BK036-12 ..1 ...		3.75" ....	3/4" ....	23.14
2BK036-14 ..1 ...		3.75" ....	7/8" ....	23.14
2BK036-16 ..1 ...		3.75" ....	1" .....	23.14
2BK036-18 ..1 ...		3.75" ..	1-1/8" ..	\$23.14

Stock No.	Type	O.D.	Bore	Price
2BK036-22 ..1 ...		3.75" ..	1-3/8" ..	23.14
2BK040-10 ..2 ...		3.95" ....	5/8" ....	25.30
2BK040-12 ..2 ...		3.95" ....	3/4" ....	25.30
2BK040-14 ..2 ...		3.95" ....	7/8" ....	25.30
2BK040-16 ..2 ...		3.95" ....	1" .....	25.30
2BK040-18 ..2 ...		3.95" ..	1-1/8" ..	25.30
2BK045-16 ..2 ...		4.25" ....	1" .....	27.61
2BK045-18 ..2 ...		4.25" ..	1-1/8" ..	27.61
2BK045-22 ..2 ...		4.25" ..	1-3/8" ..	27.61
2BK047-14 ..2 ...		4.45" ....	7/8" ....	27.69
2BK047-16 ..2 ...		4.45" ....	1" .....	27.69
2BK047-18 ..2 ...		4.45" ..	1-1/8" ..	27.69
2BK050-12 ..2 ...		4.75" ....	3/4" ....	29.77
2BK050-16 ..2 ...		4.75" ....	1" .....	29.77
2BK050-18 ..2 ...		4.75" ..	1-1/8" ..	29.77
2BK050-22 ..2 ...		4.75" ..	1-3/8" ..	29.77
2BK052-16 ..2 ...		4.95" ....	1" .....	29.97

All of the above sizes are normally stocked at our Omaha location.

Sizes listed below are non-stock but may be shipped direct. Available bore sizes are marked with their size number suffix.

P.N.	Type	O.D.	1/2"	5/8"	3/4"	7/8"	1"	1-1/8"	1-3/16"	1-1/4"	1-3/8"	1-7/16"	Retail
2BK052 .. 2 .....		4.95"				-14 .....	-16 .....	-18 .....			-22 .....		\$29.97
2BK055 .. 2 .....		5.25"						-18 .....			-22 .....		32.03
2BK057 .. 2 .....		5.45"					-16 .....	-18 .....			-22 .....		32.57
2BK060 .. 3 .....		5.75"			-12 .....	-14 .....	-16 .....	-18 .....			-22 .....		34.42
2BK062 .. 3 .....		5.95"					-16 .....	-18 .....			-22 .....		36.57
2BK065 .. 3 .....		6.25"					-16 .....	-18 .....			-22 .....		39.27
2BK067 .. 3 .....		6.45"					-16 .....	-18 .....			-22 .....		41.56
2BK070 .. 3 .....		6.75"			-12 .....		-16 .....	-18 .....	-19 .....	-20 .....	-22 .....	-23 .....	42.08
2BK080 .. 3 .....		7.75"			-12 .....		-16 .....	-18 .....	-19 .....	-20 .....	-22 .....	-23 .....	52.91
2BK090 .. 3 .....		8.75"			-12 .....		-16 .....	-18 .....	-19 .....	-20 .....	-22 .....	-23 .....	59.61
2BK100 .. 3 .....		9.75"			-12 .....		-16 .....		-19 .....	-20 .....	-22 .....	-23 .....	69.17
2BK110 .. 3 .....		10.75"					-16 .....		-19 .....			-23 .....	80.52
2BK120 .. 3 .....		11.75"					-16 .....		-19 .....			-23 .....	92.08
2BK130 .. 3 .....		12.75"					-16 .....		-19 .....			-23 .....	103.56
2BK140 .. 3 .....		13.75"					-16 .....		-19 .....			-23 .....	115.22
2BK160 .. 3 .....		15.75"					-16 .....		-19 .....			-23 .....	127.25
2BK190 .. 3 .....		18.75"							-19 .....			-23 .....	144.75

Dealer Schedule.....203

Call Toll-Free 1-800-444-8666

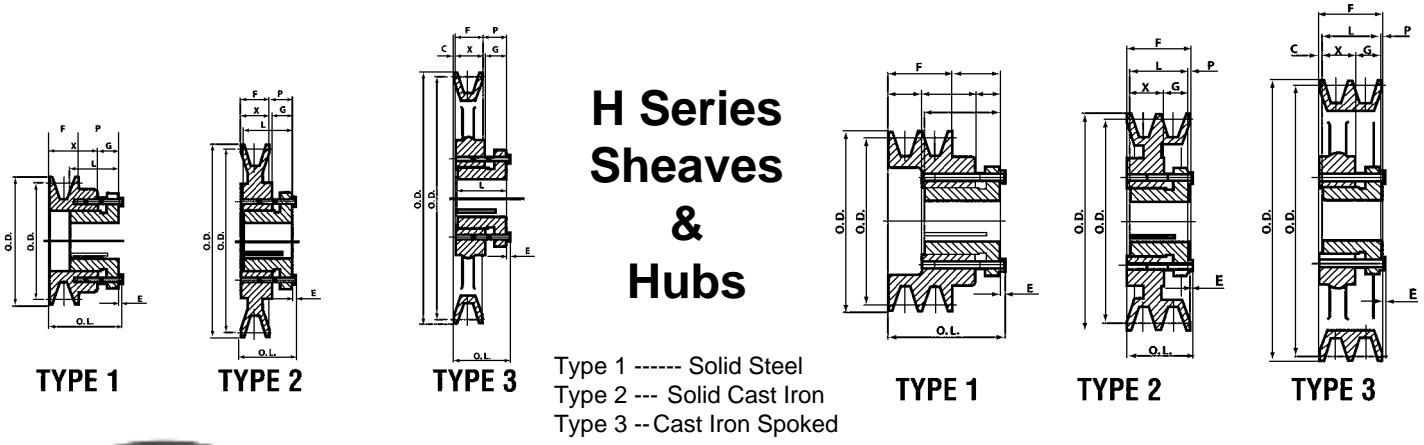

**Single Groove  
 "H" Series Cast Iron Bushed Sheave**  
 For "4L" & "5L", "A" & "B" Groove V-Belts



**Double Groove  
 "H" Series Cast Iron Bushed Sheave**  
 For "4L" & "5L", "A" & "B" Groove V-Belts

Stock No.	Type	O.D.	Price
BK030H	1	3.15	\$10.73
BK032H	1	3.35	11.45
BK034H	1	3.55	12.94
BK036H	2	3.75	14.39
BK040H	2	3.95	15.77
BK045H	2	4.25	16.65
BK047H	2	4.45	17.14
BK050H	2	4.75	18.52
BK052H	2	4.95	18.60
BK055H	2	5.25	20.00
BK057H	2	5.45	20.08
BK060H	2	5.75	21.87
BK062H	2	5.95	22.94
BK065H	2	6.25	24.42
BK067H	2	6.45	25.74
BK070H	3	6.75	25.97
BK072H	3	6.95	27.43

Stock No.	Type	O.D.	Price
BK075H	3	7.25	\$30.16
BK077H	3	7.45	31.77
BK080H	3	7.75	33.22
BK085H	3	8.25	36.16
BK090H	3	8.75	38.26
BK095H	3	9.25	39.87
BK100H	3	9.75	44.16
BK105H	3	10.25	47.43
BK110H	3	10.75	51.92
BK115H	3	11.25	56.16
BK120H	3	11.75	59.22
BK130H	3	12.75	68.16
BK140H	3	13.75	73.61
BK150H	3	14.75	79.92
BK160H	3	15.75	81.30
BK190H	3	18.75	93.38

Stock No.	Type	O.D.	Price
2BK032H	1	3.35	\$18.83
2BK034H	1	3.55	20.83
2BK036H	1	3.75	23.14
2BK040H	1	3.95	25.32
2BK045H	1	4.25	27.66
2BK047H	2	4.45	27.77
2BK050H	2	4.75	29.77
2BK052H	2	4.95	29.97
2BK055H	2	5.25	32.08
2BK057H	2	5.45	32.60
2BK060H	2	5.75	34.36
2BK062H	2	5.95	36.60

Stock No.	Type	O.D.	Price
2BK065H	3	6.25	\$39.32
2BK067H	3	6.45	41.53
2BK070H	3	6.75	42.16
2BK080H	3	7.75	53.01
2BK090H	3	8.75	59.84
2BK100H	3	9.75	69.27
2BK110H	3	10.75	80.68
2BK120H	3	11.75	92.21
2BK130H	3	12.75	103.69
2BK140H	3	13.75	115.38
2BK160H	3	15.75	127.32
2BK190H	3	18.75	144.91

Note – Metric bore hubs are available for direct shipment.  
 Sizes range from 10 thru 38MM.  
 Prices are the same as for the standard hubs.

**"H" Series Taper Hub For Above Sheaves**  
 All hubs are round bore with standard keyway.

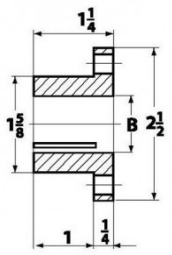

No.	Bore	No.	Bore	No.	Bore	No.	Bore
H-006	3/8"	H-016	1"	H-011	11/16"	H-021	1-5/16"
H-007	7/16"	H-017	1-1/16"	H-012	3/4"	H-022	1-3/8"
H-008	1/2"	H-018	1-1/8"	H-013	13/16"	H-023	1-7/16"
H-009	9/16"	H-019	1-3/16"	H-014	7/8"	H-024	1-1/2"
H-010	5/8"	H-020	1-1/4"	H-015	15/16"		

ALL "H" Series Hubs.....Price: \$7.22

DEALER SCHEDULE THIS PAGE.....203

**Call Toll-Free 1-800-444-8666**



# Central LIGHT DUTY V-BELTS



## 4L 1/2" TOP WIDTH

Central Number	Gates No.	O.D. Lgth.	Central Price	Central Number	Gates No.	O.D. Lgth.	Central Price	Central Number	Gates No.	O.D. Lgth.	Central Price
VB-4L180*	2180	18	\$5.30	VB-4L440	2440	44	\$7.23	VB-4L700*	2700	70	\$9.48
VB-4L190*	2190	19	5.30	VB-4L450	2450	45	7.31	VB-4L720*	2720	72	9.72
VB-4L200*	2200	20	5.30	VB-4L460	2460	46	7.51	VB-4L730*	2730	73	9.97
VB-4L210*	2210	21	5.30	VB-4L470	2470	47	7.67	VB-4L740*	2740	74	10.00
VB-4L220	2220	22	5.30	VB-4L480	2480	48	7.74	VB-4L750*	2750	75	10.14
VB-4L230	2230	23	5.30	VB-4L490	2490	49	7.80	VB-4L760*	2760	76	10.19
VB-4L240	2240	24	5.30	VB-4L500	2500	50	7.85	VB-4L770*	2770	77	10.28
VB-4L250	2250	25	5.30	VB-4L510	2510	51	7.91	VB-4L780*	2780	78	10.31
VB-4L260	2260	26	5.40	VB-4L520	2520	52	8.08	VB-4L790*	2790	79	10.47
VB-4L270	2270	27	5.42	VB-4L530	2530	53	8.10	VB-4L800*	2800	80	10.55
VB-4L280	2280	28	5.47	VB-4L540	2540	54	8.11	VB-4L810*	2810	81	10.64
VB-4L290	2290	29	5.49	VB-4L550	2550	55	8.18	VB-4L830*	2830	83	10.96
VB-4L300	2300	30	5.56	VB-4L560	2560	56	8.44	VB-4L840*	2840	84	11.19
VB-4L310	2310	31	5.58	VB-4L570	2570	57	8.51	VB-4L880*	2880	88	11.67
VB-4L320	2320	32	5.65	VB-4L580	2580	58	8.69	VB-4L900*	2900	90	11.99
VB-4L330	2330	33	5.73	VB-4L590	2590	59	8.75	VB-4L950*	2950	95	12.80
VB-4L340	2340	34	5.85	VB-4L600	2600	60	8.79	VB-4L970*	2970	97	12.89
VB-4L350	2350	35	6.05	VB-4L610	2610	61	8.81	VB-4L980*	2980	98	13.05
VB-4L360	2360	36	6.22	VB-4L620	2620	62	9.10				
VB-4L370	2370	37	6.33	VB-4L630	2630	63	9.21				
VB-4L380	2380	38	6.44	VB-4L640	2640	64	9.27				
VB-4L390	2390	39	6.55	VB-4L650*	2650	65	9.35				
VB-4L400	2400	40	6.67	VB-4L660*	2660	66	9.40				
VB-4L410	2410	41	6.84	VB-4L670*	2670	67	9.40				
VB-4L420	2420	42	6.88	VB-4L680*	2680	68	9.40				
VB-4L430	2430	43	7.12	VB-4L690*	2690	69	9.40				

**Centralize Your Buying  
With Central Supply!  
Call Toll-Free:  
1-800-444-8666**

## 5L 21/32" TOP WIDTH

Central Number	Gates No.	O.D. Lgth.	Central Price	Central Number	Gates No.	O.D. Lgth.	Central Price	Central Number	Gates No.	O.D. Lgth.	Central Price
VB-5L240	3240	24	\$6.22	VB-5L480	3480	48	\$10.09	VB-5L700*	3700	70	\$14.08
VB-5L260*	3260	26	6.22	VB-5L490	3490	49	10.28	VB-5L710*	3710	71	14.19
VB-5L280*	3280	28	6.52	VB-5L500	3500	50	10.60	VB-5L720*	3720	72	14.35
VB-5L290	3290	29	6.71	VB-5L510	3510	51	10.62	VB-5L730*	3730	73	14.46
VB-5L300*	3300	30	6.85	VB-5L520	3520	52	10.64	VB-5L740*	3740	74	14.58
VB-5L310*	3310	31	7.01	VB-5L530	3530	53	10.85	VB-5L750*	3750	75	14.69
VB-5L320*	3320	32	7.16	VB-5L540	3540	54	11.02	VB-5L760*	3760	76	14.80
VB-5L330	3330	33	7.28	VB-5L550	3550	55	11.36	VB-5L770*	3770	77	14.92
VB-5L340	3340	34	7.39	VB-5L560	3560	56	11.53	VB-5L780*	3780	78	15.03
VB-5L350*	3350	35	7.66	VB-5L570	3570	57	11.64	VB-5L790*	3790	79	15.14
VB-5L360	3360	36	7.83	VB-5L580	3580	58	11.75	VB-5L840*	3840	84	16.03
VB-5L370	3370	37	8.08	VB-5L590	3590	59	11.87	VB-5L870*	3870	87	16.97
VB-5L380	3380	38	8.33	VB-5L600	3600	60	12.09	VB-5L930*	3930	93	17.52
VB-5L390	3390	39	8.50	VB-5L610	3610	61	12.26				
VB-5L400	3400	40	8.78	VB-5L620	3620	62	12.43				
VB-5L410	3410	41	8.95	VB-5L630*	3630	63	12.54				
VB-5L420	3420	42	9.20	VB-5L640	3640	64	12.94				
VB-5L430	3430	43	9.23	VB-5L650	3650	65	13.22				
VB-5L440	3440	44	9.32	VB-5L660	3660	66	13.57				
VB-5L450	3450	45	9.36	VB-5L670*	3670	67	13.62				
VB-5L460	3460	46	9.70	VB-5L680	3680	68	13.70				
VB-5L470	3470	47	9.85	VB-5L690*	3690	69	13.82				

**Central V-Belts Are  
Fully Gauranteed Against Defects**

ALL PRICES ARE SUBJECT TO  
CHANGE WITHOUT NOTICE!



# Central

## HEAVY DUTY V-BELTS

"A" 1/2" TOP WIDTH

Fully Guaranteed Against Workmanship and Material Defects

Central #	Gates #	O.D.	Price
VB-A020*	A20	22	\$5.42
VB-A021*	A21	23	5.42
VB-A022*	A22	24	5.42
VB-A023*	A23	25	5.42
VB-A024	A24	26	5.20
VB-A025	A25	27	5.23
VB-A026	A26	28	5.27
VB-A027	A27	29	5.29
VB-A028	A28	30	5.32
VB-A029	A29	31	5.34
VB-A030	A30	32	5.38
VB-A031	A31	33	5.42
VB-A032	A32	34	5.49
VB-A033	A33	35	5.58
VB-A034	A34	36	5.74
VB-A035	A35	37	5.86
VB-A036	A36	38	5.99
VB-A037	A37	39	6.10
VB-A038	A38	40	6.22
VB-A039	A39	41	6.35
VB-A040	A40	42	6.47
VB-A041	A41	43	6.59
VB-A042	A42	44	6.84
VB-A043	A43	45	6.95
VB-A044	A44	46	7.12
VB-A045	A45	47	7.30
VB-A046	A46	48	7.41
VB-A047	A47	49	7.50
VB-A048	A48	50	7.62
VB-A049	A49	51	7.74
VB-A050	A50	52	7.85
VB-A051	A51	53	8.02
VB-A052	A52	54	8.14
VB-A053	A53	55	8.22
VB-A054	A54	56	8.31
VB-A055	A55	57	8.41
VB-A056	A56	58	8.50
VB-A057	A57	59	8.61
VB-A058	A58	60	8.75

Central #	Gates #	O.D.	Price
VB-A059	A59	61	\$8.86
VB-A060	A60	62	8.97
VB-A061	A61	63	9.10
VB-A062	A62	64	9.22
VB-A063	A63	65	9.38
VB-A064	A64	66	9.49
VB-A066	A66	68	9.74
VB-A067	A67	69	9.85
VB-A068	A68	70	9.98
VB-A069	A69	71	10.06
VB-A070	A70	72	10.32
VB-A071	A71	73	10.42
VB-A073*	A73	75	10.66
VB-A075	A75	77	10.90
VB-A076	A76	78	10.96
VB-A077	A77	79	11.32
VB-A078	A78	80	11.41
VB-A079	A79	81	11.66
VB-A080	A80	82	12.07
VB-A081	A81	83	12.16
VB-A082	A82	84	12.25
VB-A083	A83	85	12.34
VB-A084	A84	86	12.37
VB-A085	A85	87	12.43
VB-A086*	A86	88	12.61
VB-A087*	A87	89	12.77
VB-A090	A90	92	13.13
VB-A096	A96	98	13.44
VB-A097*	A97	99	13.56
VB-A098*	A98	100	13.68
VB-A099*	A99	101	13.84
VB-A105	A105	107	14.41
VB-A108*	A108	110	14.97
VB-A112	A112	114	15.82
VB-A120*	A120	122	18.14

Dealer Schedule: (except \*).....325

\*Denotes Dealer Schedule.....304

**Call Central for all your belt needs!**

Most non-stock belts are available for same day or next day direct shipment. These include A, B, C, and D heavy-duty belts; AX, BX and CX heavy duty premium notched belts; 3VX and 5VX premium notched wedge belts; B,C, D, 3V, 5V and 8V banded belts and AA, BB and CC hex (double-V) belts, timing belts and industrial V-ribbed belts.

PRICES ARE SUBJECT TO CHANGE WITHOUT NOTICE.

*Centralize with  
Central Supply!*

**Toll-Free**

**1-800-444-8666**



"B" Belt  
5/8" Top Width

# Central HEAVY DUTY V-BELTS

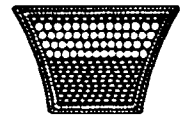

"C" Belt  
7/8" Top Width

Fully Guaranteed Against Workmanship and Material Defects

### "B" 5/8" TOP WIDTH

Central No.	Gates No.	O.D. Lgth.	Central Price	Central No.	Gates No.	O.D. Lgth.	Central Price	Central No.	Gates No.	O.D. Lgth.	Central Price
VB-B028	B28	31	\$7.06	VB-B059	B59	62	\$12.25	VB-B090	B90	93	\$18.19
VB-B029	B29	32	7.18	VB-B060	B60	63	12.31	VB-B091	B91	94	18.25
VB-B030	B30	33	7.31	VB-B061	B61	64	12.49	VB-B092	B92	95	18.48
VB-B031	B31	34	7.49	VB-B062	B62	65	12.61	VB-B093	B93	96	18.59
VB-B032	B32	35	7.67	VB-B063	B63	66	12.79	VB-B094	B94	97	18.75
VB-B033	B33	36	7.76	VB-B064	B64	67	12.92	VB-B095	B95	98	19.01
VB-B034	B34	37	7.85	VB-B065	B65	68	13.10	VB-B096	B96	99	19.26
VB-B035	B35	38	7.98	VB-B066	B66	69	13.15	VB-B097	B97	100	19.42
VB-B036	B36	39	8.28	VB-B067	B67	70	13.40	VB-B098	B98	101	19.56
VB-B037	B37	40	8.55	VB-B068	B68	71	13.51	VB-B099	B99	102	19.73
VB-B038	B38	41	8.81	VB-B069	B69	72	13.82	VB-B100	B100	103	19.85
VB-B039	B39	42	9.02	VB-B070	B70	73	13.90	VB-B103	B103	106	20.28
VB-B040	B40	43	9.19	VB-B071	B71	74	14.17	VB-B105	B105	108	20.70
VB-B041	B41	44	9.50	VB-B072	B72	75	14.31	VB-B108	B108	111	21.50
VB-B042	B42	45	9.74	VB-B073	B73	76	14.43	VB-B110*	B110	113	22.10
VB-B043	B43	46	9.88	VB-B074	B74	77	14.61	VB-B112	B112	115	22.53
VB-B044	B44	47	10.10	VB-B075	B75	78	14.74	VB-B113*	B113	118	24.01
VB-B045	B45	48	10.25	VB-B076	B76	79	14.97	VB-B116	B116	119	24.18
VB-B046	B46	49	10.54	VB-B077	B77	80	15.22	VB-B118*	B118	121	24.41
VB-B047	B47	50	10.66	VB-B078	B78	81	15.36	VB-B120	B120	123	24.80
VB-B048	B48	51	10.81	VB-B079	B79	82	15.53	VB-B126*	B126	129	25.31
VB-B049	B49	52	11.03	VB-B080	B80	83	15.89	VB-B128	B128	131	27.35
VB-B050	B50	53	11.33	VB-B081	B81	84	16.14	VB-B144	B144	147	32.21
VB-B051	B51	54	11.50	VB-B082	B82	85	16.44	VB-B148	B148	151	32.75
VB-B052	B52	55	11.58	VB-B083	B83	86	16.57	VB-B156*	B156	159	33.85
VB-B053	B53	56	11.68	VB-B084	B84	87	16.69	VB-B158	B158	161	35.03
VB-B054	B54	57	11.81	VB-B085	B85	88	16.93	VB-B162*	B162	165	36.16
VB-B055	B55	58	11.89	VB-B086	B86	89	17.12	VB-B173	B173	176	39.55
VB-B056	B56	59	11.94	VB-B087	B87	90	17.30	VB-B210*	B210	213	42.27
VB-B057	B57	60	12.05	VB-B088	B88	91	17.36	VB-B240	B240	243	51.98
VB-B058	B58	61	12.11	VB-B089	B89	92	17.42				

### "C" 7/8" TOP WIDTH

Central No.	Gates No.	O.D. Lgth.	Central Price	Central No.	Gates No.	O.D. Lgth.	Central Price	Central No.	Gates No.	O.D. Lgth.	Central Price
VB-C051*	C51	54	\$19.28	VB-C108	C108	112	\$40.78	VB-C162	C162	166	\$62.69
VB-C075	C75	79	29.12	VB-C112	C112	116	42.01	VB-C173	C173	177	64.75
VB-C081	C81	85	30.58	VB-C120	C120	124	44.74	VB-C195	C195	199	72.40
VB-C085	C85	89	31.63	VB-C128	C128	132	48.07	VB-C255	C255	258	92.67
VB-C096	C96	100	36.33	VB-C158*	C158	162	59.26	VB-C270*	C270	273	98.37
VB-C105	C105	109	39.54								

Dealer Schedule: All (except \*).....325 \*Denotes Dealer Schedule.....304

ALL PRICES ARE SUBJECT TO CHANGE WITHOUT NOTICE.

# Hobbs AGRICULTURAL HALOGEN LIGHTS

Higher Bulb Life  
400 Hour Average. 12 Volt, 50 Watt

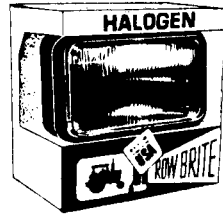

Higher Light Output - - - Up to 200,000  
Candle Power

Trapezoid - - - Flood - - - Spot

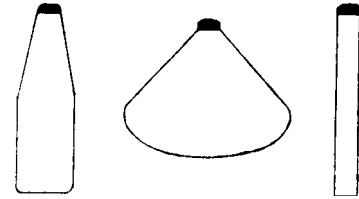

**Large 4 x 6 Size.**

No.	Description	Price
71898-50	Flood Lamp, 80 x 30 degree (Single Pack) 12 Volt	\$43.88
71915-50	Trapezoid Lamp, 30 x 25 degree (Single Pack) 12 Volt	43.88
71902-50	Spot Lamp (Single Pack) 12 Volt	43.88
72540-50	Flood Lamp, 80 x 30 degree (Single Pack) 24 Volt	56.57
72542-50	Trapezoid Lamp, 30 x 25 degree (Single Pack) 24 Volt	56.57
72544-50	Spot Lamp (Single Pack) 24 Volt	56.57
72489	Wiring and Instruction Kit	26.09

NOTE: Single Pack - - - One Lamp Per Unit. No Wiring and Instruction Kit. Double Pack - - - Two Lamps Per Unit. No Wiring and instruction Kit.

Dealer Schedule: 1 to 9.....353 10 Or More.....173 **NOTE - 4 x 6 lights may be combined for quantity discount.**

### REPLACEMENT SEALED BEAMS

No.	Description	Price
71017-50	Flood Pattern Replacement Sealed Beam, 80 x 30 degree, 12 Volt.	\$32.64
71792-50	Trapezoid Pattern Replacement Sealed Beam, 30 x 25 degree, 12 Volt.	32.64
71794-50	Spot Pattern Replacement Sealed Beam, 12 Volt.	32.64
72541-50	Flood Pattern Replacement Sealed Beam, 80 x 30 degree, 24 Volt.	37.85
72543-50	Trapezoid Pattern Replacement Sealed Beam, 30 x 25 degree, 24 Volt	37.85
72545-50	Spot Pattern Replacement Beam, 24 Volt.	37.85

Dealer Schedule: 1 To 9.....353 10 Or More.....173

NOTE: To Figure Amps divide Watts by Volts. Example: 50 Watts/12 Volts=4.17 Amps

## Row Brite Round Steel Shell Halogen Light

### FEATURES:

Higher light output & Longer bulb life than incandescent, Smaller-More compact, Adjustable easy-swivel mount,



(12 Volt, 50 Watt) For Off Road Use Only

No.	Beam Pattern	Each
73468-50	80 x 30 Flood	\$53.12
73469-50	30 x 25 Trapezoid	53.12
73470-50	Spot	53.12

Dealer Schedule: 1 To 9 ..... 253  
10 Or More ..... 173

**Note: Round lights may be assorted for quantity discounts.**

### Replacement Sealed Beams

70510-50	80 x 30 Flood	29.37
70729-50	30 x 25 Trapezoid	29.37
72774-50	Spot	29.37

(Fits All Par 36 Applications)

Dealer Schedule: 1 To 9 ..... 353  
10 Or More ..... 173

## RECTANGULAR 3" x 5" HALOGEN LAMPS

### FEATURES:

Higher light output & Longer bulb life than incandescent, Smaller-More compact, Adjustable easy-swivel mount,

AVAILABLE BEAM PATTERNS:

80° x 30° FLOOD & SPOT  
30° x 25° TRAPEZOID

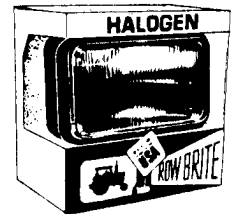

(12 Volt, 50 Watt, 4 Amp) For Off Road Use Only

No.	Beam Pattern	Each
73761-50	80 x 30 Flood	\$38.96
73763-50	30 x 25 Trapezoid	38.96
73764-50	Spot	38.96

Dealer Schedule: 1 To 9 ..... 353  
10 Or More ..... 173

**NOTE: 3 x 5 lights may be assorted for quantity discount.**

### REPLACEMENT BULBS

72408-50	80 x 30 Flood	31.01
72801-50	30 x 25 Trapezoid	31.01
73804-50	Spot	31.01

Dealer Schedule: 1 To 9 ..... 353  
10 Or More ..... 173

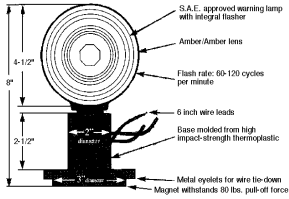

### Hobbs Warning Lamp With Handle and Magnetic Base

Brightly identifies implements, wagons, and other equipment being towed behind slow moving vehicles.

Hobbs introduces a Portable Warning Lamp that lives up to their reputation for providing tough dependable lighting products. This heavy duty Portable Warning Lamp features a two-way amber lens, magnetic base with 80 lbs. of pull off force, and a built-in flasher. You can quickly affix this rugged Warning Lamp to any machinery or equipment you are transporting.

Order No.	Description	Each
80470-01	Warning Lamp w/Flasher	\$41.76

### Hobbs Halogen Lamp With Handle and Magnetic Base

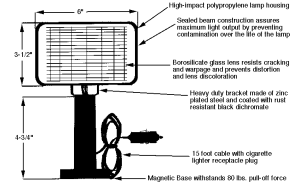

Now you can deliver the light of a rugged and reliable Hobbs Halogen when you need it and wherever you need it.

The new Portable Work Lamp operates from a cigarette lighter receptacle and features a magnetic base with 80 lbs. of pull-off force and 15 feet of cable.

It's a heavy duty work lamp perfect for FARMERS, CONTRACTORS, UTILITIES, TRUCKERS SPORTSMEN and EMERGENCY uses.

Order No.	Description	Each
80508-05	3 x 5 Flood Lamp	\$70.67
80509-05	3 x 5 Spot Lamp	70.67
80413-10	3 x 5 Flood Lamp w/Switch	84.36
80510-10	3 x 5 Spot Lamp w/Switch	84.36
80364-20	Handle Only, w/mag. base & wiring	25.16

### L.E.D. SAFETY LIGHT



2 Functions: Flashing and Steady.  
Super brightness LED visible up to 1.25 miles  
Uses four "AA" size alkaline batteries.  
Extra strong magnetic design

Order No.	Description	Each
LSL-A	L.E.D. Safety Light (Amber)	\$29.66
LSL-R	L.E.D. Safety Light (Red)	29.66
Dealer Schedule.....		152

### Hobbs Halogen Lamp With Built-In Switch

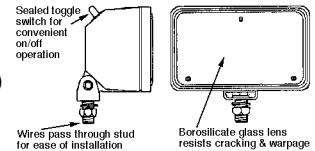

The Hobbs Halogens With Built-In Switch are simple to install in all kinds of equipment and are easy to operate. Imagine the convenience of being able to simply flip a switch and have a high intensity light clearly illuminate your work area.

The Hobbs Halogen with Built-In Switch provides light where you need it and when you need it. The sealed-beam construction and other quality features are what you've come to expect from Hobbs Halogens.

Adjustable easy swivel mount. Shock & vibration resistant. High intensity lamp (not legal for street use). Available only in 3 x 5 flood pattern. Specifications: 12 VDC - 50 Watt - 4 Amperes

Order No.	Description	Each
77861-49	Rect. Halogen Lamp w/Switch	\$55.46

DEALER SCHEDULE HOBBS ON THIS PAGE:  
1 To 9.....253      10 Or More.....173  
Quantities may be assorted

### Wire Terminal Assortment Kit

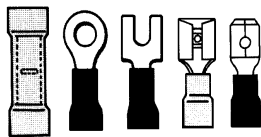
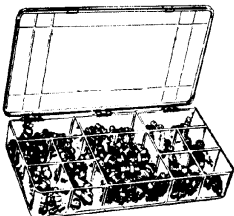

Contains 150 pieces in 12 of the most popular wire terminals and connectors. Wire gauges 10 thru 22. Packaged in a plastic assortment box with snap tight lid.

No.	Description	Net
H-12020	Wire Terminal Assortment	\$19.75

### Wire Stripping Crimping Pliers



Cuts and strips wire. Crimps solderless terminals.  
Insulated non-slip handle.

No.	Description	Price
GN-CRT	Wire Stripper/Crimping Pliers	\$6.79

Dealer Schedule.....152

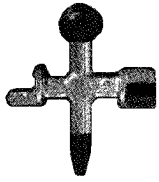

### Battery Terminal 3-Way Cleaning & Cutting Tool

No.	Description	Each
D-00682	..... Cleaning & Cutting Tool .....	\$7.79
Dealer Schedule.....103		

### Heavy-Duty Replacement Side Terminal



Fits 6 to 1 gauge cables  
3/8" bolt included.

No.	Description	Each
D-00351	..... Replacement Side Terminal .....	\$2.90

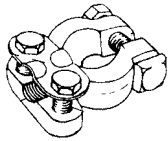

### Heavy-Duty Universal Terminals

Sold on cards of 10 only!

Bolt locks firmly from left to right. Lead Alloy. Holds clamp or strap. Threaded clamp avoids pull-out.

No.	Description	Fits Cables	Card
D-00369	..... Battery Terminal .....	6 to 2/0 gauge	\$18.94
D-00370	..... Battery Terminal .....	1 to 4/0 gauge	28.48

Dealer Schedule.....103

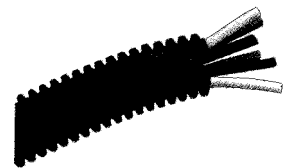

### Cable Loom

Black polyethylene corrugated loom is durable and split for easy installation. For protection of wires on cars, trucks, buses, tractors and boats. (10' minimum)

No.	Description	Per Ft.
D-05750	..... Poly Cable Loom, 3/8" I.D. ....	\$.45
D-05751	..... Poly Cable Loom, 1/2" I.D. ....	.55
D-05752	..... Poly Cable Loom, 5/8" I.D. ....	.75

Dealer Schedule: Package of 100 ft. .... 204  
10' - 99' length ..... 102

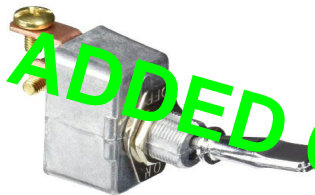

### Toggle Switch

For multi-purpose uses.  
Two position On/Off.

Dimensions: 3/4" W, 1-3/8" H, 3-1/8" L, Mounting Hole - 15/32

No.	Desc.	Volt	AMP	Price
DS167	..... Toggle Switch .....	12 / 24	50	\$6.35

Dealer Schedule: 1-5.....152, 6 or more.....253



### Clamps for Battery Chargers, Test Equipment & Booter Cables



No.	Description	Card
D-00181	..... Test Equip. Clamp (2 ea.) .....	\$3.95
D-00182	..... EZ-Reach Booster Cable Clamps (2 ea.) ....	9.95

Dealer Schedule.....103



D-00353

### Battery Terminal Adapters



D-05319

No.	Description	Each
D-00353	..... Adapts Post to Side Terminal Style .....	\$7.95
D-05319	..... Adapts Side Terminal to Post Style .....	2.90

Dealer Schedule.....103

### Extra Heavy-Duty Booster Cables



12 foot cables are made of 100% copper conductor. 4 Gauge come with parrot style clamps. 6 Gauge Equipped with low-profile E-Z Reach clamps for fast, easy attachment on hard-to-reach side and top post terminals.

No.	Description	Pair
D-00162	..... 6 gauge, w/EZ Reach Clamps .....	\$45.95
PBC412PCC	.. 4 gauge, w/Parrot Style Clamps .....	49.95

Dealer Schedule.....103

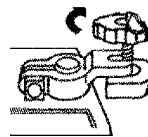

### Quick-Connect Battery Terminal

Designed for top post batteries. The cable easily detaches from the battery for anti-theft protection and to help prevent electrical drain. For use on cars, trucks, farm equipment, RVS and ATVs.

No.	Description	Each
D-00191	..... Quick-Connect Battery Terminal .....	\$7.95

Dealer Schedule.....103

### BATTERY BOLT with NUT Zinc Plated

50 Per  
Package

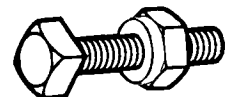

Number	Dia. x Lgth.	Per C
BBCN-05-0106	.. 5/16-18 x 1-1/4	\$60.85

Dealer Schedule:

Full Box.....104 Broken Box.....Net



## PARMAK

### Highway Warning Light



Solid state circuitry. Fully portable. One-piece Lexon non-breakable lens housing with full 18 sq. inch acrylic snap on lens. Furnished with bayonet mounting bracket & socket. Visible over 1 mile. Uses G.E. #503 bulb and standard 6V spring terminal battery. Exceeds S.A.E. specifications. Battery Not Included.

No.	Price
HWL-151 .. Highway Warning Light Amber/Amber ..	\$40.00

Dealer Schedule: 1 to 5.....152 6 or more.....152 & 205



No.	Description	Price
BAT-6LR1 ....	6-volt battery .....	6.69

Dealer Schedule: 3 or more ..... 254  
less than 3 ..... 203

### 3-IN-ONE SOCKET SYSTEM

Expand a single 12-volt vehicle power socket into three 12-volt outlets, including one outlet suitable for a cigarette lighter. LED light illuminates and makes it easy to located unit at night.



3 position adjustable offset plug allows for convenient positioning in any auto, truck, RV or marine application. Rugged, lightweight, easy to install and use . Heavy-duty, 20 Amp auto fuse.

No.	Description	Wt.	Price
VEC038 .....	Socket System .....	2	\$15.79

Dealer Schedule: 2 or more ..... 102 & 05  
1 unit..... 102

### MAXX SST Power Converter

**Converts 12 volt DC to 110 volt AC - 400W Continuous/800W Peak**

**Soft Start Technology** - Gradually and safely ramps up the output voltage to start difficult motorized loads and protect sensitive circuits.

**Automatic Reset** - Restarts automatically if the inverter shuts down, after the problem is corrected.

**Turbo Cooling** - Extends life by keeping components cooler.

**Noise Free Technology** - Filtered modified sine wave. Eliminates the horizontal lines and static that can appear on TV sets.

**Includes:** H-D Cable Clamps for direct battery connection and cigarette plug cord for lower wattage use.

**2 AC Outlets. LED power/ fault indicators. Up to 3.6 Amps.**

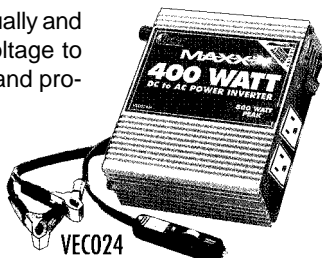

No.	Description	Wt.	Price
VEC024 .....	Power Converter, 400 watt ....	2.5	\$55.89

Dealer Schedule: 2 or more ..... 102 & 05  
1 unit..... 102

## Krylon

### Spray-On Battery Protector #K1307



A valuable tool for stopping terminal corrosion. Specially formulated to assure continued high-voltage output. Helps prolong battery life. Creates an airtight, waterproof, insulated seal to help minimize leakage.

### Spray-On Battery Cleaner #K1336

Adds life to battery terminals. Cuts through and dissolves power-robbing acid corrosion that can prevent uniform performance. Restores power. Provides a tough and dependable cleaning.

Uses: Battery terminals, cable connectors, casings and frames.

No.	Price
K1307 .... Battery Protector, 16 oz. ....	\$8.80
K1336 .... Battery Cleaner, 16 oz. ....	9.12

Dealer Schedule:

Full Case Of 6 Each.....253 Broken Case.....102

### Sprayon ELECTRICAL CONTACT CLEANER AND LUBRICANT

(Non-Ozone Depleting)

Leaves no residue to increase resistance. Cleans quickly with-out temperature control problems. Removes light contaminants, lint, dust, atmospheric oils, from precision electrical equipment. May be applied while equipment is in operation eliminating costly down time. Instant evaporation prevents clinging of airborne contaminants. Non-corrosive, non-staining. Will not harm plastic or rubber parts. Safe on all surfaces.



No.	Description	Price
02302 .....	Electrical Contact Cleaner N.O.D., 11 oz. ....	\$14.25

Dealer Schedule:

Full Case Of 12 Each.....253 Broken Case.....102

### SELF-LOCKING CABLE TIES

Weather Resistant Black

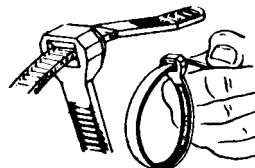

Easy to apply in seconds with hand or tool. Use to tie cable, pipe etc. Will not loosen when pulled tight.

Tensile Strength: SLT-50 - 50 lbs., SLT-175 - 175 lbs.

Bundle						
No.	Diameter	Width	Length	Pkg.	Per C	
SLT-50RB .....	1-3/4" .....	3/16" .....	7-3/8" ....	100	\$9.25	
SLT-50IB .....	3" .....	3/16" .....	11-1/2" ...	100	16.75	
SLT-50LB .....	4" .....	3/16" .....	14-1/2" ...	100	19.95	
SLT-175MB .....	7-1/2" .....	3/8" .....	25-3/4" .....	25	60.00	
SLT-175LB .....	9-1/2" .....	3/8" .....	36" .....	25	75.00	

Dealer Schedule: Full Package ..... 152  
Broken Package ..... 101

NEW PRICES AS OF 3/1/2019

NEW PRICES AS OF 3/1/2019

### OVERSIZE LOAD SIGNS

Durable yellow vinyl reinforced nylon sign with 6 grommets. Black lettering 12" high, sign size 18" x 7". Meets AASHO Recommendation #3.04.C5

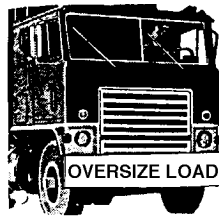

No.	Price
187WLS ..... Oversize Load Sign .....	\$35.25
Dealer Schedule.....152	

### 757-W Stewart-Warner Hand Tachometer

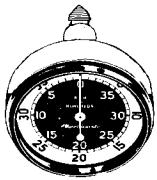

For checking rotative speeds up to 4000 RPM. Operates clockwise and counter clockwise. Face dial is two color, inner circle (counter clockwise) indications are white numerals on a black background. Outer circle (clockwise) indications are black numerals on white background.

No.	Price
82682 ..... Hand Tachometer .....	\$212.50
96798 ..... Extra Cone Tip .....	6.00
96799 ..... Extra Flat Tip .....	6.00
Dealer Schedule.....202	

### Stewart-Warner Engine Hour Meter

Electric self-starter type meter. Indicates hours and accumulated number of hours of operation. A rotating disc in upper left segment of the face acts as an operation indicator, making one revolution a minute. Registers up to 10,000 hours, then returns to 0. Aluminum case. diameter of flanged rim, 2-7/8". Applications include tractors, trucks, marine motors, earth moving equipment, irrigation pumps, any unit driven by diesel or gasoline engines or on testing work.

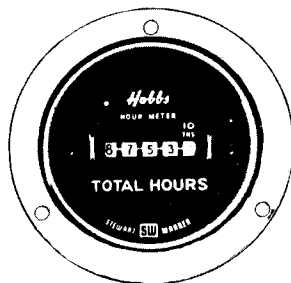

DIRECT READING

No.	Price
83501 ..... 6,12,24,36 V, 4 To 15 V Range .....	\$101.15
M-329 ..... Universal Bracket .....	13.50
Dealer Schedule.....102	

### Slow Moving Vehicle Emblem

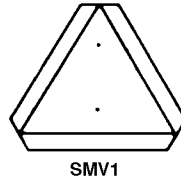

SMV1

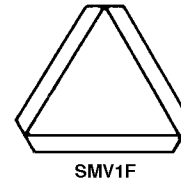

SMV1F



SMV7



SMV5



SMV6

During the night, the bright fluorescent orange solid triangle in the center of the SMV emblem is highly visible. It gains the attention and recognition of approaching motorists at distances exceeding one fifth mile. They have ample time to slow down.

At night, the reflective red border of the SMV emblem glows brilliantly in path of approaching auto headlights. The unique, hollow red triangle immediately identifies a slow moving vehicle.

**NEW HIGH REFLECTIVE SMV Emblem is visible up to 1200 feet, instead of 600 feet like the standard emblem.**

The emblem is a unique identification for, and shall be used only on, vehicles which are designed to travel at speeds of less than 25 miles per hour on public roads. The emblem is not a clearance marker for wide machinery, nor is it to replace either lighting or marker devices now required.

#### MEETS WITH NEW ASAE 5276.3 COMPLIANCE

No.	Price
SMV1 ..... SMV Emblem, film on prepunched metal backing for direct mounting ....	\$10.50
SMV1FP ..... SMV Emblem Film Decal (1 piece factory positioned) for direct mtg. ....	8.80
SMV2 ..... SMV Emblem (HIGH REFLECTIVE) metal backing for direct mounting ....	14.50
SMV2FP ..... SMV Emblem (HIGH REFLECTIVE) Prepositioned film decal .....	11.90
SMV5 ..... Mounting Socket with nuts & bolts ...	2.30
SMV6 ..... Pole Mounting Assembly (Mounting Socket NOT included) .....	5.15
SMV7 ..... Spade Mounting Assembly (Mounting Socket NOT included) .....	2.85

Dealer Schedule: 12 Or More .....	203
Less Than 12 .....	152

### Safety Warning Reflector Kit

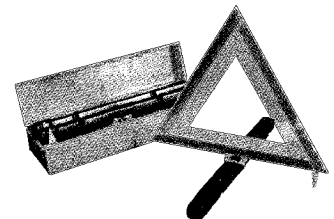

Set of 3 Safety Warning Triangle Reflectors with mounts complete with compact carrying case. Meets Federal Motor Vehicle Standard #125. Required equipment for all semi-trailers.

No.	Price
8TF ..... Safety Warning Reflector Kit .....	\$30.50

Dealer Schedule.....152

Call Central

Toll-Free

1-800-444-8666

## EZ-Slide Graphite Lubricant

SLICK AS ICE..CONVENIENT AS PAINT  
Prevents hang up of High Moisture Grain & Forage Crop in Gravity Boxes, Chutes, Forage Boxes, Wagon Boxes.



EZ-Slide lubricants can be sprayed, brushed or rolled onto any metal or wood surface to reduce sliding friction.  
Drying takes just minutes, leaving a slippery, long-life coating that becomes smoother and slicker with use. Grit, dust and chaff won't stick to it. Rain, heat & freezing won't affect it.  
EZ-Slide lubricants are the most effective products made to prevent hang-up of high moisture grain in hoppers and gravity boxes. So well do they protect metal against rust and corrosion many users apply them for that purpose alone.

No.	Size	Per Case	Price Each
33005F .....	1 qt. ....	4 .....	\$15.75
33015F .....	1 gal. ....	4 .....	42.24
33203 .....	(Aerosol) .....	6 .....	8.48

Dealer Schedule: Full Case ..... 203  
Broken Case ..... 151

### Spray-On Dry Graphite Lube



Dry Graphite Lube is a high lubricity graphite that adheres to most surfaces with minimum surface preparation. It air dries rapidly at room temperature to provide clean, long-wearing lubrication. This lube is also conductive and may be used where lubrication and electrical properties are both required. NSF reg. no. 131585; H2 rated Ideal where a dry lubricant is required or where petroleum products must be avoided Adheres with minimum preparation. Effective up to 850°F constant and 1000°F intermittent. Excellent conductivity Dries rapidly at room temperature Coefficient of friction is .09, per ASTM D4118 Recommended Uses: Pre-assembly lubrication of moving parts, mechanisms of vending machines and parking meters, automotive and industrial gaskets, bearings, locks, springs, hinges, sliding surfaces on machines, CRTs, plating nonconductors and curing ovens.

No.	Description	Each
00204 .....	Dry Graphite Lube, 16 oz. ....	\$10.70

### Spray-On Galvanizing Compounds



#### #00739 Silver Galvanizing Compound

Sacrificial coating that inhibits corrosion on ferrous metals. Excellent touch-up for repair of galvanized substrates. Produces a dry coating with the bright finish of hot-dipped galvanizing.

#### #00740 Zinc-Rich Cold Galvanizing Compound

Fast-drying, high-solids, epoxy-based coating. Provides maximum protection to steel exposed to corrosive environments. Fuses zinc to the metal substrate to protect against corrosion; equal to or better than hot-dipped galvanizing. 97%-pure zinc dust. May be top coated with conventional primers or finish coats. Meets or exceeds MIL-P-26915C. Outstanding weld thru primer. Highly resistant to salt corrosion and water.

No.	Description	Each
00739 ..	Silver Galvanizing Compound, 16 oz. ...	\$14.35
00740 ..	Zinc-Rich Galv. Compound, 16 oz. ....	13.50

Spray-On Dealer Schedule:  
Full Case Of 12 Each.....253 Broken Case.....102

## EZ-SLIDE Powdered Graphite Seed-Flow Lubricant



Packed especially for the ag. market, in a convenient plastic shaker with an Easi-Pour spout. Designed for use in high-speed planters and other farm equipment, to ensure proper lubrication and reduce friction. Just shake it on - it helps the planter deposit 100% of the seed where you want it.

#### Key Features:

Maximizes yield and profit by increasing plant population per acre. Easiest, most economical way to apply seed-flow lubricant - No buildup. Helps prevent "bridging" of seeds in planter. Helps seed flow smoothly and evenly through high-speed planters. Reduces wear on planter plates. Available in 1 lb. and 5 lb. containers

No.	Description	Per Each
RM-9950-1 .....	1 lb. bottle w/Spout (24/case) .....	\$6.96
RM-9950-5 .....	5 lb. bottle w/Spout (4/case) .....	21.72
RM-9950-4 .....	40 lb. plastic lined carton (1/case) .....	97.40

### EZ-SLIDE Talc/Graphite Mixed Powder Lubricants

EZ-Slide 80/20 & 50/50 Talc/Graphite Seed-Flow Dry Powder is blended especially for use with treated seed in planting boxes. Developed for use in pressure planters for controlling moisture issues and lubrication, it also works exceptionally well in conventional planters in replacement of fine graphite.



#### Key Features:

Designed exclusively for treated seed. - Use in both "gravity flow" and "air" planters. - Increases planting efficiency and maximizes yield per acre. - Reduces moisture issues, lubricates seed and equipment. - Helps prevent "seed bridging" in planter. - High-purity for less meter wear. - Non-toxic. - Apply 4-6 oz. each time hopper is filled with seed.

#### Talc Lubricant



Maximizes yield and profit by increasing plant population per acre. - Reduces moisture generated by vacuum planters. - Helps prevent "bridging" of seeds in planter by reducing moisture. - Helps seed flow smoothly & evenly through vacuum meter planters. - Reduces wear on vacuum meter components.

No.	Description	Per Each
RM-0901 .....	80/20 Talc/Graphite, 8 lb. Bottle (4/case) .....	\$31.54
RM-0901-4 .....	80/20 Talc/Graphite, 40 lb. Plastic Lined Ctn. ....	54.26
RM-0902-2 .....	50/50 Talc/Graphite, 20 lb. Plastic Lined Ctn. ....	57.11
RM-0902-4 .....	50/50 Talc/Graphite, 40 lb. Plastic Lined Ctn. ....	82.65
RM-1900 .....	Talc Powder Lubricant, 8 lb. Pail (4/case) .....	23.60

Dealer Schedule: Full Case ..... 203  
Broken Case ..... 151

### SPRAY-ON HEAVY DUTY PAINT AND GASKET CEMENT REMOVER

Cuts through gasket cements, sealants and adhesives. Leaves surface clean, ready to install a new gasket. Allow remover to penetrate into the old finish and do the work for you. When blistering action is completed (approximately 20 to 30 minutes) scrape off with putty knife or squeegee. Removes acrylic enamel (hi-bake and air dry), acrylic lacquer, alkyd enamel, epoxy and urethane finished, varnish, shellac, spray paint, crayon, pencil and decals from wood, glass, metal, concrete, stone, brick, ceramic tile and other surfaces.

No.	Description	Price
00615 ....	Paint & Gasket Cement Remover, 15 oz. ....	\$10.45



**Sprayon Welders Anti-Spatter**  
(Liquid Type)

Non-inflammable. Does not contain silicone. Liquid type formulation designed for the prevention of spatter build-up. Non-greasy. Use anti-spatter liquid for all types of welding. Applications: Mig nozzles, contact tips, weldments, electrode holders, fixtures, resistance welding tips and wheels.

**Welders Anti-Spatter (Powder Type)**

Non-flammable. Prevents adherence of spatter to metal surface during welding. Does not contain silicone. Provides a quick easy means of spraying anti-spatter to the work surface prior to welding. Eliminates the need for CHISELING, WIRE BRUSHING OR GRINDING after welding. Dries to whitish film to expose cracks in weld. After welding the powder is easily removed by brushing or wiping. Easily painted after welding.

No.	Price
00742 ..... Anti-Spatter (Liquid) 16 oz. ....	\$7.85
00741 ..... Anti-Spatter (Powder) 16 oz. ....	7.90

**Sprayon P.D.R.P. (Waxy Film)**  
Penetrant Demoisurant-Rust Preventative

P.D.R.P. #00710 (a product similar to Cosmoline) meets performance requirements of MIL-C-16173D Grade IV for rugged, long-term outdoor or salt water protection.



APPLICATIONS: External surfaces of machines, machine tools, internal combustion engines, fabricated parts, tubings and stampings, tools, dies, outdoor electrical systems, aircraft cargo pits and landing gear, mold saver.

No.	Price
00710 .... P.D.R.P. (Waxy Film) 12 oz. ....	\$10.25

**ALL-PURPOSE SILICONE LUBRICANT**



All Purpose Silicone Lube is an economical lubricant for applications where petroleum based products are not desired. This 5% silicone formula protects against air and moisture to retard oxidation and corrosion. It virtually eliminates friction and sticking to improve high-speed production. Leaves a long lasting film that is compatible with most surfaces.

5% silicone formula. Reduces friction and sticking; protects against corrosion and oxidation with an invisible film that repels water. Compatible with most surfaces; will not attack

most plastics. Will not interfere with painting or decorating. Effective from -50°F to +375°F. Equipped with SPRAY ANYWAY™ valve and extension tube. Recommended Uses: Rubber moldings, windows, sliding wood surfaces, sewing equipment, sliding racks, dissimilar metals, springs, leather, doors, hinges, weather-stripping and plastic assemblies.

No.	Description	Price
00206 .....	Silicone Lubricant, 10 oz. ....	\$9.35

**SPRAY-ON #711**

**PENETRANT-LUBRICANT,  
DEMOISTURANT AND RUST PREVENTATIVE**



Penetrates microscopic irregularities of surface in allowing the release of frozen or corroded parts. Demoisurizes by displacing surface moisture, providing a protective barrier between moisture and the metal surface. Lubricates with a unique blend of lubricating ingredients, thus eliminating the need for silicones or old fashioned oils which leave a sticky or gummy residue. Inhibits corrosion by depositing a long lasting, rust preventative film which displaces and repels water. Will not harm plastic, rubber, fabrics or painted surfaces.

No.	Description	Price
00711 .....	Penetrant Lubricant, 12 oz. ....	\$8.60

**Sprayon RUST BREAKER**

**Penetrates frozen nuts & bolts - Displaces moisture - Prevents corrosion - Non-flammable propellant - High dielectric strength - Jet stream spray**



Rust Breaker's accelerated action quickly loosens rust, while penetrating grease and dirt. A transparent, non-staining oil, its light film also displaces moisture and acts as a corrosion preventative. Will not affect most painted surfaces.

Rust Breaker's non-flammable propellant has no flashpoint for increased safety. Applicator sprays up to two feet in a jet stream, assuring saturation of working areas only—preventing unnecessary waste and allowing safe application on moving parts.

Model	Description	Price
00103 .....	Spray-On Rust Breaker 12 oz. ....	\$10.55

**Sprayon BLAST 'EM**  
**Wasp & Hornet Killer**



Kills wasps, hornets, yellow jackets, flies, mosquitoes, and flying moths, and is EPA registered. It contains a high amount of petroleum distillates for the best knockdown and kill rate, and its flood type valve sprays a stream 20 feet. Residual deposit will kill returning wasps & hornets. Will not harm most plastics. Dielectric strength: 33,000 volts. Read label for proper indoor use.

Ideal for utility meters and boxes; nesting areas in eaves and shrubs; doors and window frames; outdoor light fixtures, etc.

No.	Each
00857 .....	Wasp & Hornet Killer, 12 oz. ....
	\$11.25

**TRI-FLOW Industrial Lubricant**



Tri-Flow is a unique premium formulation of 14 ingredients including micronized Teflon, high-grade petroleum oils, corrosion inhibitors, moisture displacers, cleaners penetrating ingredients and extreme pressure additives.

**Dramatically reduces friction and wear** on moving parts, making them work smoother, quieter, longer.

**Penetrates quickly** to loosened rusted or sticky parts by washing away dirt, corrosion and contaminants. **Protects against rust and corrosion** even under the most severe conditions.

No.	Each
20027 .....	TRI-FLOW Lubricant, 12 oz. ....
	\$18.90

### SPRAY-ON Upside-Down Marking Paints

Fluorescent High Visibility OSHA & APWA Colors



Sprayon's Upside-Down Marking Paints feature the convenient spray-through caps & non-clogging tip.

For traffic, utility and general purpose marking. 20 oz. cans with non-clogging valve. Minimal finger pressure required. Use 6" distance for writing. Can be used up to 18" distance for marking.

Uses: Concrete Surface, Pavement, Utility Marking, & Excavation Marking. Good adhesion to: Grass, Soil, Gravel, Asphalt, Cement & Cable.

No.		Price
03610	.... Safety Red (Electrical Lines) .....	\$6.90
03612	.... Hot Pink (Construction & General Marking) .....	6.90
03620	.... Caution Blue (Water Lines) .....	6.90
03630	.... Safety Green (Sewer Lines) .....	6.90
03700	.... Alert Orange (Communication Lines) .....	6.90

### ENAMEL SPRAY PAINT FOR INTERNATIONAL, AND JOHN DEERE

SPRAYON'S enamels are made from the finest materials available. They are fast drying, permanent and cannot be accidentally removed. Meets Military, Federal, ASA and Weapon Specifications.

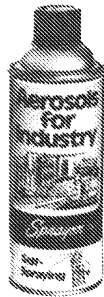

THE DANVERN VALVE A SPRAYON EXCLUSIVE

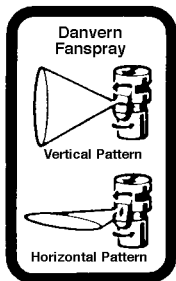

Danvern fan spray provides a smooth elongated pattern (rotate valve tip 1/4 turn for horizontal or vertical fan spray pattern) which can be overlapped like a spray gun. This design offers significant advantages, such as, better and faster coverage, while using 10 to 12 inches required by aerosol valves. This valve permits lighter finger pressure - only 1/4 to 1/2 the pressure required or other aerosol valves with reducing overspray, resisting clogging, producing finer atomization and instant shut-off.

No.		Price
K1816	.... Krylon John Deere Yellow, 12 oz. ....	\$9.75
K1817	.... Krylon John Deere Green, 12 oz. ....	9.75
K1818	.... Krylon International Red, 12 oz. ....	9.75
K1819	.... Krylon Caterpillar Yellow, 12 oz. ....	9.75
K1927	.... Krylon Ford Blue, 12 oz. ....	9.75

#### PRIMERS

00342	.... Red Oxide Primer, 12 oz. ....	8.21
00341	.... Light Gray Primer, 12 oz. ....	8.21

### Krylon Maintenance Engine Paint

Fast-drying, high performance acrylic enamel. Withstands temperatures up to 500° F. Matches OEM standards. Won't blister, flake, crack or peel. Oil and gas resistant.

K1611	.... Engine Paint, Gray, 12 oz. Spray .....	10.05
-------	---	-------

### Krylon Maintenance High Heat Paint

Withstands temperatures up to 1000° F. Provides a clean, durable finish. Dries to the touch in minutes. Uses: Steam pipes, heaters, boilers, diesel and gasoline engines and gas grills.

K1614	.... High Heat Paint, Black 12 oz. Spray .....	11.75
-------	--	-------

### SPRAY-ON BLUE LAYOUT FLUID

Easy to apply - saves time, mess and cleanup. Adheres to metal and glass. Fast drying, non-flaking, non-etching, won't peel. Heat resistant and non-corrosive. SMOOTH NON-GLARE finish allows clear and precise scribe lines. Sprayon's patented Danvern Fanspray Valve reduces overspray and waste, permitting 20% more coverage.

APPLICATIONS: Inspection departments, tool & die, pattern layouts, production layouts, sheet metal.



No.		Price
00603	..... Blue Layout Fluid, 12 oz. ....	\$9.52

### LAYOUT FLUID REMOVER

Specifically formulated for easy, clean and quick removal of #00603 Blue Layout Fluid. Also effective as a remover of lacquer materials. Leaves no residue. Comes with Sprayon's patented Danvern Standard valve. May harm certain plastics.

No.		Price
00606	..... Layout Fluid Remover, 12.75 oz. ....	\$8.85

### Sprayon

### GENERAL PURPOSE CLEANER



DOES NOT STREAK. Cleans surfaces fast and easy thru foaming action. Just spray it on and wipe it off immediately for sparkling clean surfaces everytime. Leaves no film to attract dirt and is non-staining. Contains ammonia for effective grease cutting. Excellent on glass, vinyl, finished wood, porcelain, formica and chrome.

No.		Price
00880	..... General Purpose Cleaner, 12 oz. ....	\$6.35

### Sprayon Engine & General Purpose Degreaser (Water Soluble)

Powers away dirt, grease and varnish deposits. It is non-corrosive, non-staining. Will not damage wiring, insulation, distributor caps or painted surfaces. Easy to apply and flushes clean with water. Allow product to set a for minimum of 15 minutes for better cleaning results.



No.		Each
00702	.... Engine & General Degreaser, 12 oz. ....	\$9.52

### Sprayon

### BRAKE & PARTS CLEANER

Non-Chlorinated - Fast Evaporating Leaves No Residue



Designed for fast, effective removal of dirt, oil, grease, wax and tar. **Uses:** Electric motors, brakes, gears, clutches, molds, generators, tools, machinery, engines and mechanical equipment.

No.		Each
00705	.... Brake & Parts Cleaner, 14 oz. ....	\$6.75

Spray-On Dealer Schedule:

Full Case Of 12 Each.....253 Broken Case.....102

NEW PRICES AS OF 3/1/2019

## Permatex THREADLOCKER GEL-TWIST

Threadlocker Gel in the GEL TWIST pin point applicator is the true innovation in Threadlocking! Applicator leaves the Threadlocker where you want it...on the part! Threadlocker will not drip or run, and is easily portable. Reduces waste and makes it great for use in vertical applications. Extended nozzle allows for easy application in hard to reach locations. **Threadlock Blue** can be removed with hand tools. **Threadlock Red** requires heat or special tools for removal.



No.	Description	Each
PX-24010	Threadlocker Blue, Med. Strength	\$15.50
PX-27010	Threadlocker Red, High Strength	15.50
Dealer Schedule.....		152

## Permatex FORM-A-GASKET #2

Reliable paste-like gasket sealant/dressing/coating. Best suited for non-rigid vibrating assemblies. Use to 400°F. Resistant to gasoline and solvents. Conforms to MIL-S-45180D.

No.	Description	Each
PX-80016	Form-A-Gasket #2, 3 oz. tube, carded	\$5.25
PX-80011	Form-A-Gasket #2, 11 oz. tube, carded	11.20
Dealer Schedule.....		152

## Knock'er Loose PENETRANT

An industrial strength, low viscosity super penetrant designed to quickly loosen and free seized, bound or frozen fasteners. Quickly permeates rust, scale, gum, grease and corrosion. 18 oz. Spray Can.



No.	Price	
1724W	Knock'er Loose Penetrant-Lubricant	\$8.25
Dealer Schedule: Full Case Of 12 Each		253
Broken Case		102

## PB Blaster Penetrating Catalyst

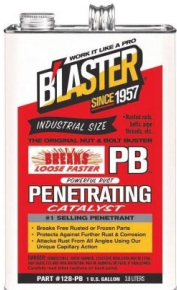

Quickly breaks loose the surface tension of frozen parts and protects against further rust and corrosion.

Eliminates fighting with rusted and frozen fasteners and parts, and works where other penetrating lubricants fail. PB Blaster

does not evaporate and remains on the surface to lubricate and protect against further corrosion. Also an excellent cleaner for corroded fasteners.

No.	Price	
PB016	PB Blaster Penetrating Catalyst, 16 oz.	\$6.95
PB128	PB Blaster Penetrating Catalyst, 1 Gal.	39.20

Dealer Schedule: 16 oz. Full Case of 12		253
16 oz. Broken Case		102
Gallon		253

## J-B WELD

### Drill It - Grind It - Weld It

Easy to Use. Repair, Fills and Bonds. Can Be Used On Iron, Steel, Copper, Aluminum, Brass, Bronze, Pewter, Wood, Porcelain, Ceramic & Plastic.



No.	Description	Each
8265-S	J-B Weld (*Contains Two Tubes)	\$7.45
8276	J-B WELD Kwik-Set	7.45

\*One tube contains metal in a liquid base. Second tube contains hardened compound.

Dealer Schedule: 6 Or More	152
Less Than 6	102



## E-Z Break Anti-Seize Compound

Copper-based anti-seize and lubricating compound. Resists rust and corrosion. Recommended for coating nuts, bolts, valves, flanges, splines, for easy break out after years of service. Meets Mil. Spec. Mil-A-907E. Authorized by USDA for use in meat and poultry plants. Temperature to 1800°F.

No.	Description	Each
LC-08910	E-Z Break, 10oz. Brush in Cap	\$21.00
LC-08916	E-Z Break, 14oz. Aerosol	25.32

Dealer Schedule.....152

## Cool Gel Heat Barrier Spray



Helps prevent heat damage to components and surrounding materials during soldering, brazing, and welding. Protects painted and finished surfaces from discoloration due to adjacent torch operations. Unique gelled formula sticks to surfaces without dripping or running off. Clear, non-staining gel leaves no residue eliminating cleanup. Safe, non-toxic, harmless to skin and odorless. Reduces danger of fire to surrounding surfaces such as rubber and plastic seals and gaskets.

No.	Description	Each
LC-11509	Cool Gel Heat Barrier Spray	\$25.50

Dealer Schedule.....152

**You Can Rely On  
Central Supply  
For Fast Shipment  
Of Your Order!**

### Silver Duct Tape

General purpose grade. Used for water-proofing, weatherproofing, repairing, packaging & sealing.

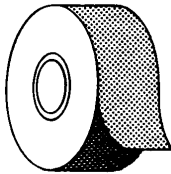

No.	Description	Case	Per Roll
UT-1022 ..	2" x 60 yds. Duct Tape .....	24 ...	\$9.36

### Fiberglass Reinforced Packaging Tape WATER ACTIVATED

The perfect tape for packaging needs. Two sheets of kraft paper cemented to a fiberglass webbing for 3-way strength. Pliable and Extra Tough!

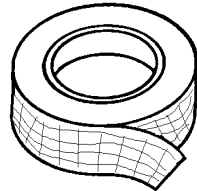

No	Description	Per Roll
BX-341 ....	2.75" wide x 420' roll Glassweb Tape .....	\$12.49

### Reinforced Strapping Tape

Extra strong pressure-sensitive fiber-glass filament reinforced tape. Excellent for sealing, strapping & bundling.

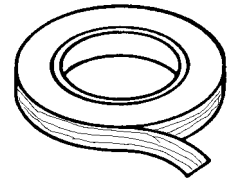

No.	Description	Case	Per Roll
UT-22 .....	1" x 60 yds. Strapping Tape .....	36 ...	\$5.16

### Clear Adhesive Packaging Tape

General purpose polypropylene film tape for box and bag sealing applications.

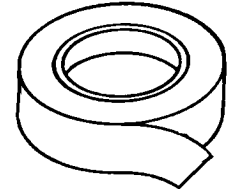

No.	Description	Case	Per Roll
UT-PPP ...	2" x 55 yds. Packaging Tape .....	36 ...	\$3.03

Dealer Schedule: Full Case.....103 Broken Case.....202

## MEAN GREEN Super Action Heavy-Duty Cleaners

- Biodegradable
- No Phosphates
- No Solvents
- Non-Flammable
- Environmentally Friendly



**Super Strength Cleaner & Degreaser** is ready to use on tough jobs with the most power of any all-purpose spray cleaner. Total economical cleaning for the home, office or industrial situations in diluted solutions or at environmentally safe full strength. It is highly recommended for cleaning machinery and has been proven to be a great detergent, surface cleaner and degreaser. Mean Green works great as a carpet cleaner and floor wax stripper and is great for household ovens and outdoor grills. Mean Green is without a doubt the best engine cleaner on the market. It requires little or no scrubbing and replaces all other solvents and degreasers. USDA Authorized.

**Zap Glass & All-Purpose Spray** cleaner performs like two products in one. It cleans glass with no haze or streaks while tackling the tasks of all-purpose cleaners. Zap is gentle to the skin and safe for all surfaces and the environment.

**Mildew Destroyer & Cleaner** removes mildew, soap scum, grime and algae from the kitchen and bathroom twice as fast as other leading brands, and is environmentally safe. Mildew Destroyer & Cleaner is ideal for institutional and hotel usage.

**No Scrub Tire Cleaner Plus** cleans car and truck tires without scrubbing. Simply spray No Scrub on the tire and rinse to leave a rich new satin black color. No Scrub Tire Cleaner Plus also effectively degreases engines, tools and other tough cleaning tasks.

No.	Description	Case	List
MG-105 .....	Super Strength Cleaner 8 oz. ....	24	\$2.39
MG-100 .....	Super Strength Cleaner 32 oz. Spray .....	12	5.38
MG-101 .....	Super Strength Cleaner 1 Gallon Refill .....	4	10.95
MG-200 .....	ZAP! Glass Cleaner 32 oz. Spray .....	12	5.38
MG-600 .....	Mildew Destroyer 32 oz. Spray .....	12	5.38
MG-900 .....	No-Scrub Tire Cleaner 32 oz. Spray .....	12	5.38

Dealer Schedule: Full Case ..... 253  
Broken Case ..... 102

Also Available In 30 & 55 Gal. Drums. Call For Pricing!



### Vinyl Electrical Tape

**Standard-Duty Electrical Tape**  
General purpose, 7 mil, U.L. Approved.

No.	Description	Case	Per Roll
UT-602 ....	3/4" x 60' Electrical Tape .....	200 ..	\$1.33

Dealer Schedule: Full Case ..... 155  
10 Rolls to Case Qty. .... 104  
1-9 Rolls ..... 102

### Rags IN A BOX Shop Towels

Clean, white, remarkably soft rags. Cloth-like Strength with Sponge-like Absorbency. White, 1 Ply, 10"x13" shop rag in a pop-up dispenser box with carrying handle.



No.	Description	Count	Per Box
75600 .....	Rags In A Box .....	350 .....	\$26.95

Dealer Schedule.....152

**Call Central**

**Toll Free:**

**1-800-444-8666**

## Central BROWN KRAFT BAGS

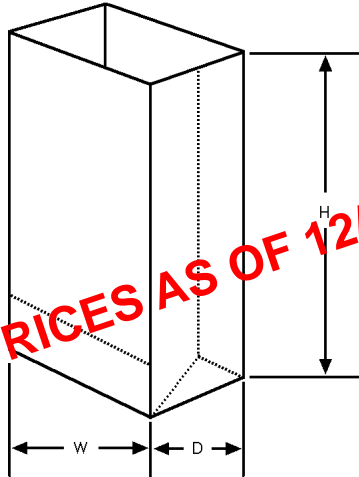

**NEW PRICES AS OF 12/4/2018**

**BX-G Grocery bags** are made of 30 weight paper.  
**BX-U Utility bags** are made of Heavy-Duty 50 weight paper.  
 (Minimum Quantity 1 Bundle)

No.	H	W	D	Bundle	Bale	Per C
BX-G02	8"	4-1/8"	2-5/8"	500	6000	\$7.79
BX-U02	8"	4-1/8"	2-5/8"	500	3000	9.69
BX-U06	11-1/16"	6"	3-5/8"	500	2000	10.95

Dealer Schedule.....152

## Heavy-Duty Steel Parts Bin

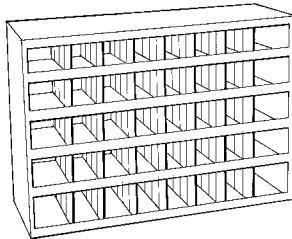

Dimensions:  
 21-1/2" H, 35-1/4" W, 12" D

Made of prime cold rolled steel. Will not warp, twist or sag.  
 Modular design makes it easy to combine to make larger units.

Order No.	Description	Net
CX-40B....	Steel Parts Bin, 40 Bin Unit.....	\$160.49

**For Other Sizes Of Parts Bins and Compartment Boxes**  
**Call Central Supply For Prices and Availability!**

**Call Central Supply**  
**TOLL-FREE 1-800-444-8666**  
**FAX TOLL-FREE 1-800-342-7252**

## Central BIN BOXES

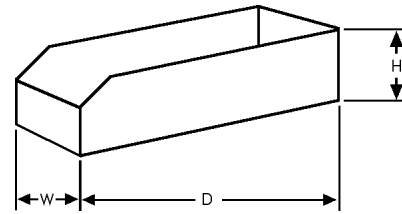

The economical, efficient way to store small parts. Ideal for storerooms, repair shops, warehouses, etc. Hopper front provides fast, easy identification and access. Constructed of high-test corrugated fiberboard for durability. "Snap and lock" feature keeps bin rigid. Shipped flat. Easy to assemble. (50 per bundle.)

Order No.	D	W	H	Each
BX-1224	12"	2"	4"	\$1.31
BX-1244	12"	4"	4"	1.61
BX-1264	12"	6"	4"	1.72

Dealer Schedule:	Full Bundle	152
	Broken Bundle	151

## Steel Compartment Boxes & Racks

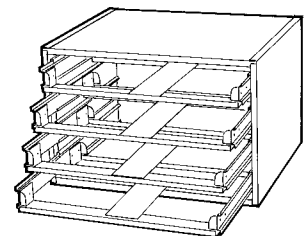
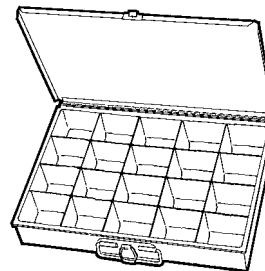
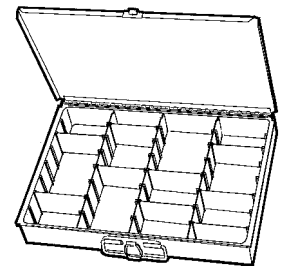
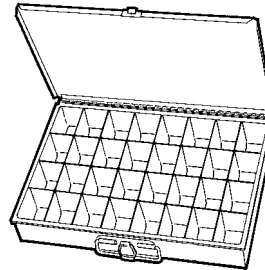

**Compartment boxes** are manufactured of prime cold rolled steel and finished in rust and acid resistant baked enamel, and have high impact styrene inserts. Features: carrying handle, positive pull-down catches. Size: 18"x12"x3"

**Rack** is reinforced for strength and supports loaded boxes in the open position without tilting. Special stops prevent units from being accidentally pulled from the rack. Size: 20"x15"x15-3/4"

No.	Description	Net
CX-DL20	20 Scooped Compartments .....	\$34.95
CX-DL24	24 Scooped Compartments .....	34.95
CX-DL32	32 Scooped Compartments .....	34.95
CX-ADL	Adjustable Compartments w/9 dividers .....	36.90
CX-ADL-DIV	Extra Dividers f/ADL Box (Pkg. of 9 Ea.) ...	6.95
CX-4LR	4 Drawer Compartment Box Rack .....	135.96



## Flambeau Poly Parts Bins

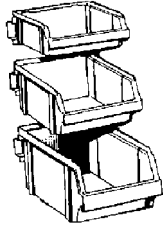

Wide front opening allows visibility and easy access. Sizes for large and small storage needs. Standard width allows stacking of all sizes.

STACK OR HANG BIN SYSTEMS Perfect for organizing a workbench in the home, shop or garage. No other system offers the strength and durability of our high impact, copolymer bins. Bins are available in sizes for every large and small storage need. Standardized width permits stacking, even with different style bins.

Order No.	Description	WxDxH	Price
UT-12000	.... Poly Parts Bin (1 Liter)	5"x6-3/4"x3" ..	\$4.09
UT-24000	.... Poly Parts Bin (2 Liter)	5"x9"x4" .....	4.99
UT-48000	.... Poly Parts Bin (4 Liter)	5"x12"x6" .....	6.93

Dealer Schedule.....152

## Tuff Tainer Utility Boxes

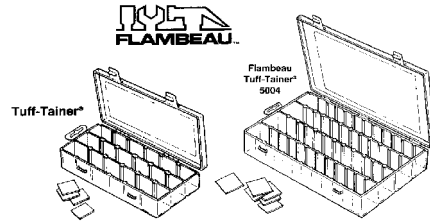

These see-through boxes made of tough polypropylene, resist most common chemicals, gasoline, oils and plastics. Built to take abuse, with double hinges and "No-Spill" latch.

- #2003 has 2 fixed & 15 removable dividers.
- #3003 has 2 fixed & 9 removable dividers.
- #4007 has 3 fixed & 12 removable dividers.
- #5007 has 3 fixed & 18 removable dividers.

Description, LxWxH	Each
UT-2003 ... Tuff-Tainer Box, 7"x4-1/8"x1-1/2" .....	\$4.41
UT-3003 ... Tuff-Tainer Box, 9-1/8"x5"x1-1/4" .....	5.53
UT-4007 ... Tuff-Tainer Box, 11"x7-1/2"x1-3/4" .....	8.30
UT-5007 ... Tuff-Tainer Box, 14"x9"x2" .....	11.06

Dealer Schedule.....152

## Flambeau Parts Cabinets

See-thru Drawers - Industrial Quality

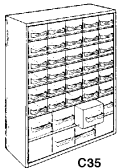

These storage cabinets are lightweight, extra durable, and ideal for organizing small parts, tools, and fasteners. Designed for maximum storage flexibility and long lasting durability. Each cabinet features crystal clear see-thru drawers. Drawer stops prevent accidental spills. Easily mounted on walls or stacked. Color is gray. Drawer size: 1.375"x2"x5.25".

No.	Parts Cabinets WxDxH	Each
UT-130	..... 12"x6.25"x11.25", 30 Drawer .....	\$30.80

Dealer Schedule.....152

## Tuff-Tainer Satchel Space Case

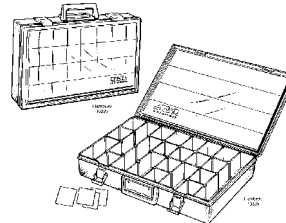

Comfortable carrying handle with draw-tight latches. 24 removable dividers makes from 8 to 32 compartments. Durable transparent lid for easy identification of contents. Dimensions: 18-1/2"x13"x 3"

No.	Description	Each
UT-10320	.... Tuff-Tainer Space Case .....	\$47.85

Dealer Schedule.....152

## FOLDING WORK CENTER

By Flambeau

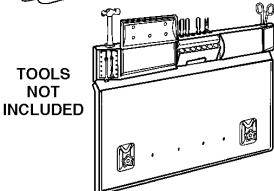
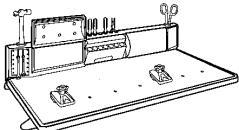

TOOLS NOT INCLUDED

Working surface measures 24"x 48". Folds down to less than 4-1/2" from wall in seconds. Contains multiple storage areas. Includes two adjustable/removable clamps on work surface. Locking bolt & spring system holds up to 300 lbs. U.V. protected for outdoor use. Easy to assemble.

No.	Description	Each
UT-48240	.... Work Center .....	\$174.99

Dealer Schedule.....152

## Poly Parts Bags



Reclosable Zip-Lock Heavy 4 Mil thickness

Sold in packages of 100 each

Clear polyethylene reclosable bags are an economical, easy-to-use and versatile solution, whether you need to package, ship, display or protect your product. Identify contents easily. White block accepts marker, pen, rubber stamp or grease pencil. FDA/USDA approved.

Order No.	Mil	Width	Height	Per C
PBZ-04-0304W	..... 4 .....	3" .....	4" .....	\$9.45
PBZ-04-0406W	..... 4 .....	4" .....	6" .....	12.25
PBZ-04-0609W	..... 4 .....	6" .....	9" .....	21.38

Dealer Schedule: Full Case of 1000 ..... 304  
Package of 100 ..... 152

ALL PRICES ARE SUBJECT TO CHANGE WITHOUT NOTICE.

**Ball-Foot Air Chuck**

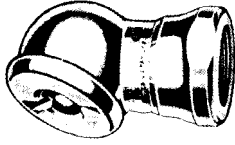

No.	Price
PF2120..... Air Chuck, 1/4" NPTF .....	\$5.90
Dealer Schedule.....152	

**Golden Rod Slip-On Blow Gun**

No.	Price
106C... Blow Gun ....	\$17.27
Dealer Schedule.....203	



**NEW PRICES AS OF 3/8/2019**

**Safety Blow Gun**

Chrome plated, heavy walled, & light weight. 1/4" NPTF. Shipping wt. 8 oz.

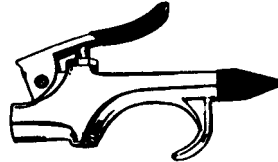

No.	Price
NS-1562 ..... Safety Blow Gun, 1/4" NPTF .....	\$11.21
Dealer Schedule.....152	

**Quick Connect Air Coupler**

1/4" NPT (Female)



**NEW PRICES AS OF 3/8/2019**

**TOOL BRUTE™**

100% INDUSTRIAL QUALITY - MADE IN USA

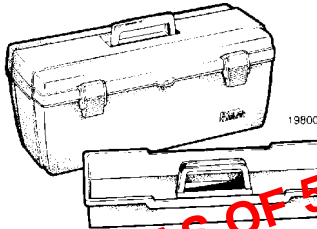

Tool Brute™ Tool Boxes offer outstanding value and performance. High impact copolymer construction is dentproof, rust-proof, non-conductive and resists most common chemicals. The rounded corners won't nick or gouge surfaces. The tongue-and-groove design keeps water out while adding strength, and the solid brass hinge and latch pins won't rust or corrode. Plus, padlock tabs provide added security. Lift out tray helps keep things organized. Color: Gray

No.	Description	Price
UT-19800 ...	Tool Brute 20, 20-1/4"x8-7/8"x8-3/8" ...	\$38.57
Dealer Schedule.....152		

**NEW PRICES AS OF 5/16/2020**

MALE THREAD      FEMALE THREAD

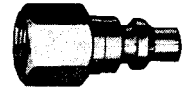

No.	Price
H-715 ..... Quick Connect Air Coupler, 1/4" .....	\$7.60
H-727 ..... Air Nipple, 1/4" Male .....	2.98
H-728 ..... Air Nipple, 1/4" Female .....	3.50
Dealer Schedule.....152	

**"DE-LUXE" AIR HOSE**



For Service Stations, Garage, Implement Dealers, etc. 2-Ply Heavy Construction. 250 lbs. Working Pressure, 1/4" I.D. 25' With 1/4" Male N.P.T., Both Ends.

No.	Price	
1425A .....	25' x 1/4", 2 Braid Air Hose .....	\$23.50
Dealer Schedule: 3 or more.....253      Less than 3.....152		

**Order On-Line:**  
[www.centralsupplyandrubber.com](http://www.centralsupplyandrubber.com)

**Order By Phone:**  
**1-800-444-8666**

**By Fax: 402-341-0860**

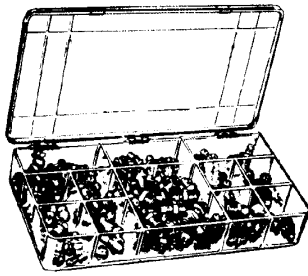

## Zerk Fitting Assortments

Zerk Fittings Packaged in a transparent plastic box with heavy duty hinges and snap-tight lid.  
Box size 8-1/2" x 4-3/4" x 1-1/2".

#ZA-100 Consists of				#ZAM-060 Consists of			
No.	Qty.	No.	Qty.	No.	Qty.	No.	Qty.
1610B	20	1641B	40	2106	10	2104	5
1612B	10	1637B	10	2107	10	2105	5
1613B	10	1911B	10	2108	10	2109	5
				2103	5	2110	5
						2111	5

No.	Description	Price
ZA-100	Zerk Fitting Assortment .... (Dealer Net)	\$40.58
ZAM-060	Metric Zerk Assortment .... (Dealer Net)	38.67

## Small Zerk Fitting Assortments

Packaged in a plastic bag

#ZA-011 consists of 2 ea. 1610B, 1641B, 1728B, 1 ea. 1611B, 1613B, 1637B, 1743B, 1911B.

#ZA-016 consists of 2 ea. 1610B, 1611B, 1613B, 1637B, 1641B, 1728B, 1743B, 1911B.

No.	Description	Price
ZA-011	11 pc. Zerk Assortment .....	\$4.96
ZA-016	16 pc. Zerk Assortment .....	7.29

Dealer Schedule:		
12 or more assorted	.....	383
7-11 assorted	.....	203
Less Than 7	.....	152

## METRIC ZERK FITTINGS

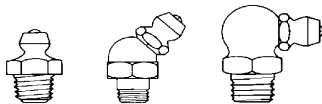

No.	Pipe Thread	Length	Angle	Each
Z-2106	6mm	19/32"	Straight	\$.32
Z-2107	6mm	13/16"	45 Degree	.69
Z-2108	6mm	3/4"	90 Degree	.69
Z-2103	8mm	5/8"	Straight	.37
Z-2104	8mm	13/16"	45 Degree	.92
Z-2105	8mm	3/4"	90 Degree	.92
Z-2109	10mm	5/8"	Straight	.49
Z-2110	10mm	13/16"	45 Degree	.94
Z-2111	10mm	3/4"	90 Degree	.94

Dealer Schedule:		
Packages of 25 each	.....	152
Broken Packages	.....	201

## Zerk Drive In Tool

For Straight Drive In Fittings



No.	Description	Price
L11485	Zerk Drive In Tool .....	\$13.75

Dealer Schedule:		
Packages of 25 each	.....	152
Broken Packages	.....	201

## Hydraulic Zerk Fittings

### 1/8" Pipe Thread Straight

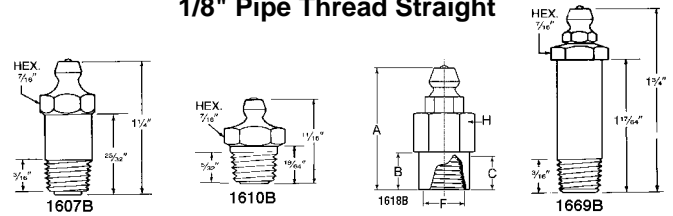

No.	Length	Thread	Each
Z-1607B	1-1/4"	1/8" NPTM	\$1.40
Z-1610B	11/16"	1/8" NPTM	.37
Z-1618B	1"	1/8" NPT Female	.87
Z-1669B	1-3/4"	1/8" NPTM	1.88

### 1/8" Pipe Thread Angle

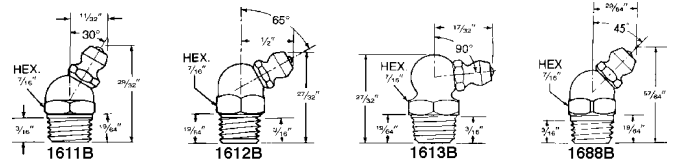

No.	Length	Angle	Each
Z-1611B	29/32"	30 Degree	\$.90
Z-1612B	27/32"	65 Degree	.68
Z-1613B	27/32"	90 Degree	.68
Z-1688B	29/32"	45 Degree	.69

### 1/4"-28 Taper Thread

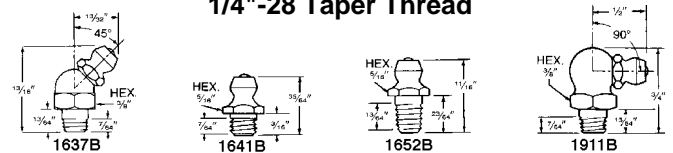

No.	Length	Angle	Each
Z-1637B	13/16"	45 Degree	\$.63
Z-1641B	35/64"	Straight	.25
Z-1652B	11/16"	Straight	.33
Z-1911B	3/4"	90 Degree	.64

### 1/4" Pipe Thread - - - Straight & Angle

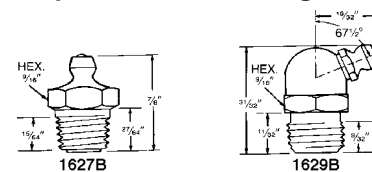

No.	Length	Angle	Each
Z-1627B	7/8"	Straight	\$.94
Z-1629B	31/32"	65 Degree	1.60

### Drive Fittings

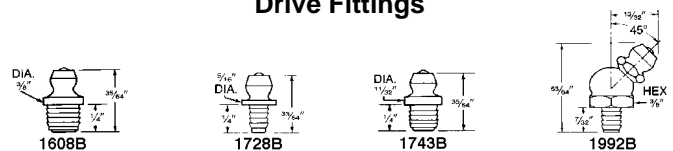

No.	Drive Size	Length	Angle	Each
Z-1608B	5/16"	9/16"	Straight	\$.38
Z-1728B	3/16"	33/64"	Straight	.29
Z-1743B	1/4"	35/64"	Straight	.29
Z-1992B	3/16"	53/64"	45 Degree	1.56

Dealer Schedule:		
Packages of 25 each	.....	152
Broken Packages	.....	201

# Plews

## H-D Lever Action Barrel Pump

Zinc plated for maximum rust and corrosion resistance. Brass piston rings for multi-purpose usage. Pumps lubricants, agricultural and industrial chemicals, anti-freeze, and other non-corrosive fluids. Dispenses approx. 3/4 pint per stroke. Fits 15-55 gallon drums with 2" bung openings. **NOT for use with diesel exhaust fluid.**

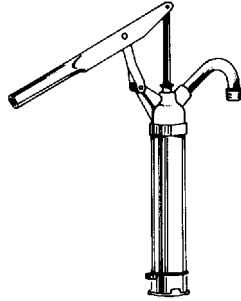

No.	Price
GG-55-123 ..... Lever Action Barrel Pump .....	\$61.00
Dealer Schedule.....152	

## FIL-E-ZEE Grease Gun Filler



Fits full open head pails through 5 gallon size. Includes pump, pail cover, #107023 Follower Plate and one #80 Loader Nipple.

No.	Price
NS-328 .. Grease Gun Filler	\$73.75

Dealer Schedule.....152

## Grease Gun Hoses



Flexible Grease Hose for Hand-Operated Grease Guns Only.

Description	Price
GGH-12 ..... 12" Grease Gun Hose .....	\$7.31
GGH-18 ..... 18" Grease Gun Hose .....	8.44
GGH-24 ..... 24" Grease Gun Hose .....	9.58
GGH-36 ..... 36" Grease Gun Hose .....	11.85
Dealer Schedule.....152	

## Plews Grease Gun Accessories

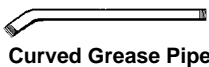

Curved Grease Pipe



Grease Gun Coupler



**Bulk Filler Fitting**  
Used to convert grease gun, not equipped with filler nipple, to filler type



Grease Injector Needle

No.	Description	Price
GG-05-030 .. Standard Grease Gun Coupler .....		\$3.60
GG-05-034 .. Heavy-Duty Grease Gun Coupler .....		10.70
GG-5852 ..... Lincoln Grease Gun Coupler .....		8.45
GG-05-061 .. 1/8" x 6" Curved Grease Pipe .....		4.80
GG-05-047 .. Grease Gun Bulk Filler Fitting .....		3.45
GG-05-037 .. Grease Injector Needle .....		4.75

Dealer Schedule.....152

# Plews Grease Guns

## Model 30-300

### Pistol-Matic Grease Gun

One-hand operation. three-way loading: cartridges, bulk, loader nipple. Gun takes all 14 oz. and 14-1/2 oz. cartridges. Coupler has ball check to prevent leakage and loss of pressure. Packaged in individual poly bag.

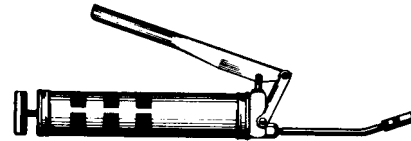
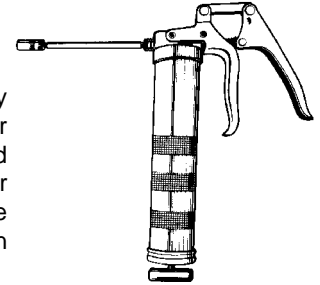

## Model 30-449 Lever Action Grease Gun

10,000 PSI capability. Electrostatic coated. Packaged in individual poly bag with grease pipe and coupler.

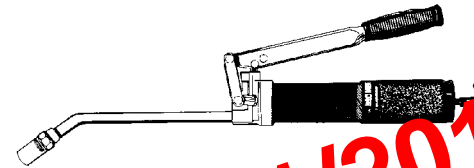

## Model 30-480 H-D "The Ultimate" Grease Gun

The toughest, most productive grease gun in the world today. Designed specifically for heavy-duty use and built to take extreme punishment. **Features:** 18-gauge steel barrel, Delivers twice the volume of grease per stroke compared to standard guns, Maintains pressure and grease flow on short strokes in confined spaces, Hydraulic coupler features non-drip seal to prevent leakage, Three-way loading, 10" pipe gets to hard-to-reach grease points.

No.	Description	Price
GG-30-300 ..... Pistol-Matic Grease Gun .....		\$28.30
GG-30-449 ..... Lever Action Grease Gun .....		20.70
GG-30-480 ..... "Ultimate" Grease Gun .....		54.30

Dealer Schedule: 6 Or More Guns ..... 203  
Less Than 6 Guns ..... 152

## Multi-Purpose Lithium Grease



Long-lasting, hard-working formula delivers high performance in wide range of heavy-duty applications. Recommended for chassis, universal joints and other general-purpose applications around the home, farm or shop. Works best for lubricating rolling parts.

No.	Description	Price
GG-10625 ... Lithium Grease, 14 oz. cartridge .....		\$5.05

Dealer Schedule: Package of 10 ..... 152 & 05  
Less than 10 ..... 152

## Grease Gun Swivel Extension

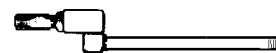

No.	Price
NS-48 ..... 360° Swivel Extension, 1/8" NPT .....	\$31.61

Dealer Schedule.....152

NEW PRICES AS OF 3/11/2019

## "GoldenRod" Hydraulic Pump Oilers

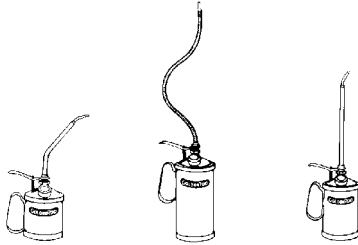

Handles any oil that flows, from gasoline to heaviest oils. Delivers 1 to 150 drops per stroke as desired, no waste. Produces 250 pounds tip pressure. Welded steel construction. One piece natural grip steel handle. Diameter of base 3-1/2".

Dealer Schedule.....203

No.	Description	Price
120-C	1 Pint Pump Oiler	\$32.08
120-B	1-1/2 Pint Pump Oiler	33.17
120-A	1 Quart Pump Oiler	34.97
Note - - Spout NOT Included.		
301012	12" Straight Spout	8.52
301013	10" Straight Spout	8.52
301014	8" Straight Spout	8.52
301015	12" Angle Spout	8.52
301016	10" Angle Spout	8.52
301017	8" Angle Spout	8.52
301024	10" Flexible Spout	8.52
301025	12" Flexible Spout	8.52
301026	15" Flexible Spout	8.52
120-1	Brass Spout Tip	4.41
120-4	Filler Cap	4.41
120-6	Thumb Lever	4.41

## Gasoline Hose

(Grounded)



No.	Diam.	Length	Ends	Price
GH-1210	3/4"	10'	3/4" IPT	\$64.76
GH-1220	3/4"	20'	3/4" IPT	93.33
GH-1610	1"	10'	1" IPT	91.45
GH-1620	1"	20'	1" IPT	116.19

Dealer Schedule.....152

## "GoldenRod" Pistol Oiler



1/3 Pint Capacity  
5" Straight Spout

No.	Description	Price
600	Pistol Oiler	\$12.99

Dealer Schedule ..... 203

Finest quality small capacity pump oiler. For mechanics, home or farm. Seamless drawn steel body. Double seemed base. Unexcelled pump action. Baked copper bronze finish.

## Plews Grease Gun Holder



Holds any standard grease gun with approx. 2-1/2" tube.

No.	Description	Price
GG-70-901	G-Gun Holder	\$9.00

Dealer Schedule ..... 152

## Gasoline Hose Nozzle

(3/4" Nozzle Pipe)



No.	Description	Price
NS-1538	Aluminum Gas Nozzle, 3/4" Inlet	\$32.00
NS-1539	Aluminum Gas Nozzle, 1" Inlet	32.00

Dealer Schedule.....152

## Central Utility Pans

Made of durable impact resistant rubberized plastic that will not break or crack even when used in cold weather. Slick non-stick finish. Used for feeding, oil changes, plants, pet dishes etc.

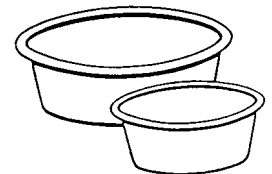

No.	Description	Price
UP-1	Utility Pan (1 Gallon)	\$5.25
UP-3	Utility Pan (3 Gallon)	6.60

Dealer Schedule.....152

## Suction Gun



Designed for draining and filling non-corrosive liquids. Barrel holds approximately one pint with 9" stroke. Features 12" plastic hose with durable corrosion resistant finish.

No.	Description	Price
GG-30-118	Suction Gun	\$18.60

Dealer Schedule.....152

## Polar Starting Fluid

Provides quick, smooth starting in all types of diesel and gasoline engines. (35% Ether)

No.	Description	List Ea.
PSF-082	Starting Fluid, 11 oz.	\$4.20
PSF-081	Starting Fluid, 8 oz.	3.60

Discount: Case of 12 cans ..... 253  
Broken Case ..... 102



PRICES ARE SUBJECT TO CHANGE WITHOUT NOTICE.

**GOLDENROD**

**BOWL TYPE FUEL FILTER**

For gasohol and diesel fuel on farm, in construction and light industrial use. 10 micron filtration at 5 gpm gravity flow with 24" head. 150 psi working pressure. 1" fittings. Alcohol resistant. Plastic see through bowl. Sediment drain valve. Shock and weather resistant. Zinc die cast top cap. 9-1/2" high x 4" diameter. Low cost replacement filter element with 366 square inched filtering surface.

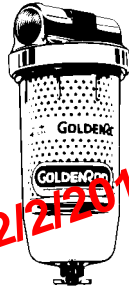

No.	Description	Price
GR495	Golden Rod Fuel Filter	\$58.90
GR495-5	Filter Element	11.06
GR495-4	Container Bowl	29.48
GR470-7	Gasket	1.15
GR491	Filter Wrench	9.41

Dealer Schedule.....33/133

**NEW PRICES AS OF 2/21/2018**

**Anthes Weathercap**

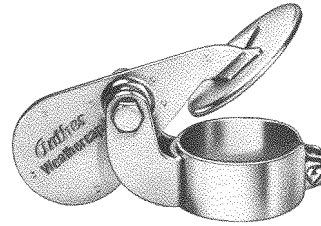

The weather cap opens with first slight pressure inside of the stack. Closes instantly when exhaust pressure stops. Full vertical opening will not block exhaust gases which can cause dangerous back pressure.

To install, simply tighten on bolt. No holes to drill, and no clamps needed.

Order No.	Type No.	Minimum Exhaust O.D.	Maximum Exhaust O.D.	Price
11003	2	1-1/2"	1-11/16"	\$13.37
11004	3	1-3/4"	1-15/16"	13.43
11005	4	2"	2-3/16"	14.20
11006	5	2-1/4"	2-7/16"	15.03
11007	6	2-1/2"	2-11/16"	15.28
11008	7	2-3/4"	2-15/16"	15.46
11009	8	3"	3-3/16"	15.74
11010	9	3-1/4"	3-7/16"	18.00
11011	10	3-1/2"	3-11/16"	18.63
11012	11	3-3/4"	3-15/16"	18.86
11013	12	4"	4-3/16"	19.51
11014	13	4-1/4"	4-7/16"	19.51
11015	14	4-1/2"	4-11/16"	22.46
11017	16	5"	5-3/16"	22.71

Dealer Schedule.....203

**NEW PRICES AS OF 5/25/2021**

**GOLDENROD**

**SPIN-ON FUEL FILTERS**



596

**Standard Spin-On Fuel Filter**

For use with gasoline, gasohol, microscopic particulars (10 microns) of rust, sand, dirt, scale, filtering surface. Working pressure up to 50 PSI. Maximum recommended flow rate: 12 GPM. Ideal for farm, construction, industrial, and service station use.

**Water-Block Spin-On Filter**

For use with gasoline and diesel fuels. Filters microscopic particles (10 microns)

and also absorbs and removes water from fuel. Restricts fuel flow as water is absorbed, signaling the need for an element change. 201 square inches of filtering surface. Maximum recommended flow rate: 12 GPM. Ideal for farm, construction, industrial, and service station use.

**Top Cap**

For use with D-L/GoldenRod Spin-On Fuel Filters. Heavy-duty zinc die-cast. Copper bronze plated on enamel. Fits standard one inch pipe fitting.

No.	Description	Price
GR595	Standard Filter w/Top Cap	\$43.20
GR596	Water-Block Filter w/Top Cap	53.32
GR595-5	Standard Replacement Canister	13.79
GR596-5	Water-Block Replacement Canister	26.57
GR570-3	Top Cap Only	27.40

Dealer Schedule.....33/133

PRICES SUBJECT TO CHANGE WITHOUT NOTICE

**NEW PRICES AS OF 3/8/2019**

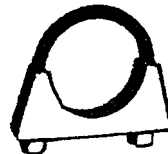

**MUFFLER CLAMPS**

All muffler clamps have heavy-duty 3/8" U-bolts. With nuts. Plain Finish

No.	Size	Price	No.	Size	Price
CL-150	1-1/2"	\$2.50	CL-250	2-1/2"	\$3.02
CL-162	1-5/8"	2.50	CL-275	2-3/4"	3.56
CL-175	1-3/4"	2.50	CL-300	3"	4.15
CL-178	1-7/8"	2.50	CL-350	3-1/2"	4.91
CL-200	2"	2.60	CL-400	4"	7.00
CL-212	2-1/8"	2.80	CL-500	5"	9.95
CL-225	2-1/4"	2.80			

Dealer Schedule.....152

**DIAPHRAGM HAND PUMP**

Fuel Pump with 8' hose and 2" threaded base



Fits 15 thru 55 gallon tanks with 2" bung openings. A double acting, diaphragm type pump for dispensing gasoline, diesel fuel and similar petroleum products. Steel aluminum telescoping tube assembly with neoprene seal. 8' hose with discharge nozzle. Delivers approximately 1 gallon per nine strokes.

No.	Description	Price
NS-30A2	Diaphragm Hand Pump	\$217.10

Dealer Schedule.....152

**NEW PRICES AS OF 3/8/2019**

# DELUXE SNOWCO UMBRELLA

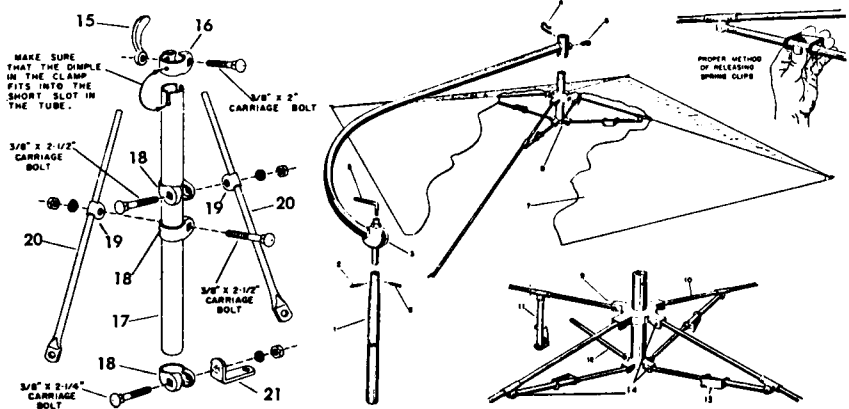
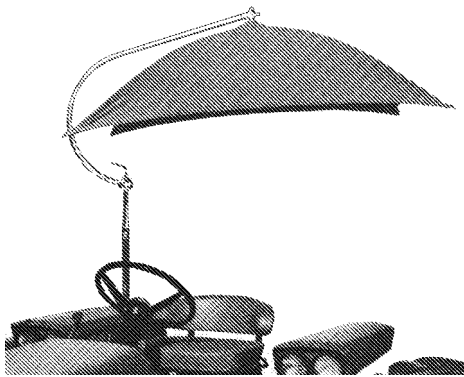

Rugged Construction - - - All steel to withstand shocks and bumps of hard usage. Shafts of 1-1/4" steel tubing; bows of oil tempered spring steel: all metal zinc coated to resist rust. Covers, 51" square, made of double stitched 8 oz. double filled duck. Corners reinforced with leather and provided with heavy steel grommets.

The deluxe umbrella gives protection against sun and wind never before afforded. It can be tilted to any angle and to any position - - - front, back or either side - - - without interfering with the operator, who always has plenty of room to sit or stand. Folds to one side when not in use.

No.	Description	Price
405-466	Red Umbrella, Less Bracket	\$127.10
405-467	White Umbrella, Less Bracket	127.10
405-468	Yellow Umbrella, Less Bracket	127.10
405-200	Universal Bracket	32.90
405-408	Blue Canvas Cover Only	49.80
405-411	Red Canvas Cover Only	49.80
405-412	White Canvas Cover Only	49.80
405-413	Yellow Canvas Cover Only	49.80

## UMBRELLA REPAIR PARTS

No.	Ref.	Description	Price
405-125	1	Support Shaft	\$23.50
405-127	3	Curved Shaft w/Adj. Swivel Ball	37.25
405-128	4	Spring Wire Safety Clip	2.25
405-129	5	Swivel Ball Locking Handle	2.65
405-503	6	Frame Locking Set Screw	1.74
405-131	8	Frame Assembly	56.33
405-132	9	Center Tube with Spiders	8.05
405-133	10	Bow with Clevis	4.30
405-134	11	Push Rod Tube	5.40
405-135	12	Push Rod	2.58
405-136	13	Push Rod Locking Spring Clip	1.20
405-176		Push Rod Rivet	.40

## BRACKET REPAIR PARTS

405-204	18	Plain Body Tube Clamp	2.10
405-205	19	Rod Clamp	1.30
405-206	20	Rod Brace (20")	4.40
405-207	21	Angle Clip	1.70

**Call 1-800-444-8666**

# SNOWCO BUGGY TOPS

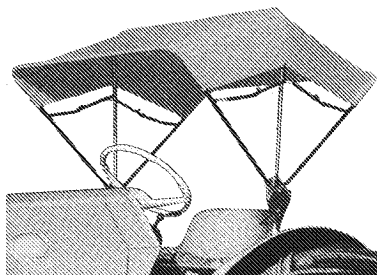

Sturdy 3-bow construction; plated metal parts; solid; top easily adjusted to variety of positions; widely adaptable; fender or axle mount.

No.	Description	Price
405-344	Fender Mounting Bracket	\$68.35
405-241	Axle Mounting Bracket	77.75

Note - - - Brackets Fit Either 40" or 48" Buggy Top.

No.	Description	Price
405-474	40" Red Buggy Top, Less Bracket	\$152.50
405-475	40" White Buggy Top, Less Bracket	152.50
405-476	40" Yellow Buggy Top, Less Bracket	152.50
405-673	48" Red Buggy Top, Less Bracket	163.10
405-674	48" White Buggy Top, Less Bracket	163.10
405-677	48" Yellow Buggy Top, Less Bracket	163.10
405-580	40" Red Canvas Cover Only	50.90
405-581	40" White Canvas Cover Only	50.90
405-582	40" Yellow Canvas Cover Only	50.90
405-590	48" Red Canvas Cover Only	55.10
405-591	48" White Canvas Cover Only	55.10
405-592	48" Yellow Canvas Cover Only	55.10

**HINSON-FEMCO TRACTOR UMBRELLA**

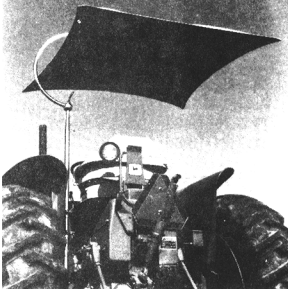

For Tractors, Combines, Industrial and Self-Propelled Equipment to insure protection against Wind, Rain, Dust and Sun.

FEATURES: Metal parts are zinc-coated for long-lasting, maintenance-free service. Shafts are constructed of 1-1/4" heavy-duty steel tubing. Rigid framework for cover, to withstand farm and industrial use. Adaptable to all types of equipment. Tilting feature permits front, back, or side protection without operator interference.

Can be used with other existing brackets. Standard umbrella cover is 25% heavier than competitive brands. Umbrella covers are 54" wide with hems to prevent fraying. Furnished with heavy cotton duck (25% heavier than competitors) with reinforcing leather behind all corner grommets.

**Umbrella comes with mounting bracket. Cover Must Be Ordered Separately!**

No.	Description	Price
HF-315022126	... Umbrella Frame, Less cover	.... \$70.00
HF-311022014	... Yellow Canvas Cover	..... 44.30
HF-311022072	... Red Canvas Cover	..... 44.30
HF-31102273	... White Canvas Cover	..... 44.30

Dealer Schedule.....152

**HINSON-FEMCO SUNSHADE - PARTS**



The Hinson-Femco metallic silver/white Sun-Shade canopy is heat and light reflective, providing insulating qualities. Actual tests show up to 30 degrees difference between the new silver/white canopy and the canvas or vinyl covers. That means real comfort for the operator!

Order No.	Description	Price
HF-303020064	... Fender Mounting Bracket	..... \$61.90
HF-318022083	... Yellow Canvas Cover	..... 51.25
HF-318022067	... White Canvas Cover	..... 51.25

Dealer Schedule.....152

**GOLDEN ROD *Hired Hand* Barbed Wire Stretcher & Splicer**



No.	Description	Price
GR415	..... Hired Hand Fence Stretcher	..... \$87.39
GR415-5	..... Replacement Spring Set f/GR415	..... 7.65
GR28	..... Small Spring f/GR405	..... 2.40
GR29	..... Large Spring f/GR405	..... 2.40

Dealer Schedule.....203

**Pigtail Step-in Electric Fence Post**



42" length.  
Super heavy duty 9/32" (7.1mm) Galvanized steel rod.  
Designed to work with ALL wire, polywire, polytape and rope electric fences.  
Sharpened post and step-in for easy insertion in hard ground.  
Extended step-in fin design provides additional ground stability.  
Reinforced crimped foot step for increased strength.  
Will not shear off when stepping into hard/frozen ground.  
10,000 volt, ultraviolet resistant, insulation ensures fence won't short out.

No.	Description	List
P801	..... Pigtail Step-in Electric Fence Post	..... \$7.17

Dealer Schedule.....203



- Aluminum Electric Fence Wire
- No Rust - Light Weight
- Easy to Work With
- 14 gauge wire
- 1212' (1/4 mile) & 2624' (1/2 mile) Spools



No.	Description	List
DA-14AL1320	.... Alum. Fence Wire, 1/4 mile	..... \$90.00
DA-14AL2640	.... Alum. Fence Wire, 1/2 mile	..... 162.50

Dealer Schedule.....203

**ELECTRIC FENCE POSTS**

Order No.	Description	Price
SMV-38RB	.... 3/8"x 48" Rebar Fence Post	..... \$1.89

Dealer Schedule.....152

**Parmak Digital Electric Fence Tester**



Reads up to 19.9 kilovolts.  
Matches performance meter on Parmak fence chargers.  
For use with low impedance fence chargers.  
Measures fence performance to help diagnose problems.

No.	Description	Price
813	.... Electric Fence Tester	..... \$45.06

Dealer Schedule.....203



# PARMAK FINEST QUALITY ELECTRIC FENCERS

## 6 Volt Battery Operated

### Solar-Pak 6 Volt Solar Powered Fencer

America's first solar-powered electric fencer is equipped with the latest state-of-the-art solar panel. Increased output, longer life. Eliminates the need of expensive battery replacement or inconvenient recharging. Solar-Pak will operate for 21 days in total darkness. Charges up to 25 miles of fence. Complete with sealed 6-volt Gel battery. U.L. Listed

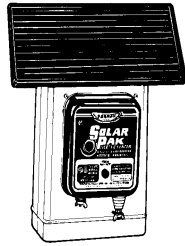

No. Price  
DF-SP-LI ..... Solar Powered Electric Fencer ..... \$282.06

100% solid state, no moving parts. Low cost, high quality model for indoor installation. A model with which you can meet any price competition. Charges up to 10 miles of fence. Uses any type 6 volt battery. UL listed



No. Price  
S-1 ..... Electric Fencer ..... \$66.05

### Solar-Pak 12 Volt Fencer (Low Impedance)

Solar powered, uses free energy from the sun. Low impedance for maximum power, longer life, no operating costs. America's first solid state solar powered fencer. Features the latest state-of-the-art solar panel. Solar-Pak has all the great Magnum 12 features plus solar power. Complete with sealed 12-volt Gel battery. Weatherproof, portable outdoor model. Charges up to 30 miles U.L. Listed

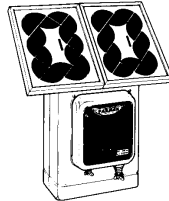

No. Price  
MAG-12-SP .... Magnum 12 Solar Fencer ..... \$434.50

**Batteries For Parmak Solar-Pak Electric Fencers**  
Sealed, leak-proof, low internal resistance 9.5 A.H. Gel replacement battery



No. Price  
901 ..... 6V Battery for DF-SP-SS Fencer ..... \$47.55  
902 ..... 12V Battery for MAG-12-SP Fencer .... 93.08

### Special current taper chargers for solar fence batteries.

No. Price  
951 ..... 6V Taper Charger ..... \$24.47  
952 ..... 12V Taper Charger ..... 24.47

### Replacement Solar Panels

Complete with steel back, battery case lid, and wire connectors.

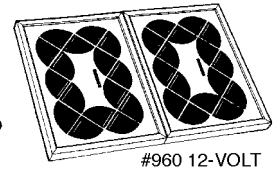
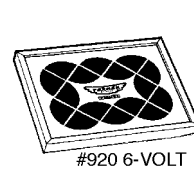

No. Price  
920 ..... 6V Solar Panel for DF-SP-SS ..... \$134.60  
960 ..... 12V Solar Panel for MAG-12-SP ..... 221.60

### Multi-Power Mark-8

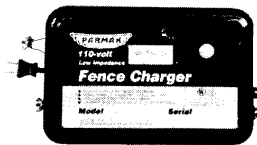

Low impedance for medium to large pastures - single or multi-wire high tensile fence. Advanced solid state circuitry featuring Parmak's exclusive built-in performance meter. Shocks through wet weeds and brush. Ideal for livestock & predator control. Furnished complete ready to plug into AC line. Fully warranted. 110-120 volts, AC. UL listed. Charges up to 30 miles of fence. Indoor installation.

No. Price  
MARK-8 ..... Multi-Power Electric Fencer ..... \$200.35

### Fieldmaster

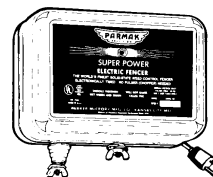

The all new low impedance model for small to medium pastures. Advanced solid state circuitry. Shocks through wet weeds & brush. Built-in operational light. For indoor installation. Charges up to 15 miles of fence UL listed.

No. Price  
FM3 ..... Fieldmaster Electric Fencer ..... \$172.92

### 12 Volt Battery Operated (Low Impedance)



12-V Battery Operated. Advanced solid state circuitry. New compact design. Equipped with performance meter that shows condition of fence. Low impedance - for livestock of predator control - medium to large pastures. Shocks through wet weeds and brush. Weatherproof, portable outdoor model. Use with 12 volt storage battery. Charges up to 30 miles. Complete with battery clamps. UL listed.

No. Price  
MAG-12UO .... 12 Volt Electric Fencer ..... \$150.80

### Super Energizer Model

The most powerful Parmak model. Low Impedance designed specifically for large pastures - single or multi-wire high tensile fences. Advanced solid state circuitry featuring Parmak's exclusive built-in performance meter. Shocks through wet weeds and brush. Ideal for controlled grazing of livestock including sheep and predator control. For indoor installation. Charges over 50 miles of fence. UL listed



No. Price  
SE-5 ..... Super Energizer Electric Fencer ..... \$227.10

PRICES AS OF 5/10/2021

## DARE FENCING PRODUCTS

### Electric Fence Energizers



Order No.	Description	Price
DA-DE400	1 joule, 25 mile - controls up to 25 acres of overgrown fence, 110V ...	\$192.50
DA-DS300	.75 joule, 20 mile - controls up to 75 acres of clean fence, 6V or 12V	181.90
DA-DS400	1 joule, 25 mile - controls up to 100 acres of overgrown fence, 12V	228.75

### Studded T-Post Insulators

For 1.25 & 1.33 lb. per ft. steel T-posts



Order No.	Description	Per Pkg.
DA-2027	T-post topper safety cap insulator, yellow, 10/pkg.	\$10.90
DA-2550-25	Pinlock, black, 25/pkg.	11.90
DA-SNUG-RT-25	3" reversed, yellow, 25/pkg.	13.90
DA-SNUG-STP-25	Standard clip-on, yellow, 25/pkg.	6.15
DA-SNUG-X5TP-25	5" extension, yellow, 25/pkg.	14.40

### Round Post Insulators

For 1/4"- 9/16" diameter posts & 5/8" fiberglass T-posts



Order No.	Description	Per Pkg.
DA-WEVERN-RP25	1" screw-tight round post insulator, yellow, 25/pkg.	\$7.75

### Studded T-Post Fastening Clips

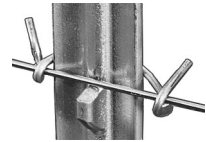

For 1.25 and 1.33 lb. per ft. steel T-posts

Order No.	Description	Per Pkg.
DA-440	Used to fasten fence or barbed wire to T-posts, 11 gauge galv. wire, 25/pkg.	\$2.20

### Wood Post Insulators



Order No.	Description	Per Pkg.
DA-1728-25	1" wood post insulator w/nails, yellow, 25/pkg.	\$4.00
DA-2285-25	Pinlock wood post insulator less nails, black, 25/pkg.	11.25
DA-2671-25	Wood post ring insulator, black, 25/pkg.	14.65
DA-SNUG-SWP-25	2" wood post insulator w/nails, yellow, 25/pkg.	6.15
DA-WOOD-5WP10	5" ext. wood post insulator w/nails, yellow, 10/pkg.	7.25
DA-3003	Power driver for wood post ring insulator (use with electric drill), 1/pkg.	7.50

### U-Post and Chain Link Fence Insulators

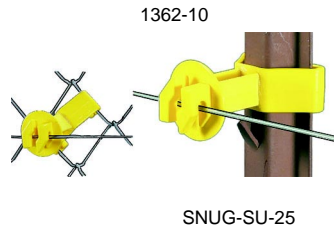

Order No.	Description	Per Pkg.
DA-1362-10	5" extension "essex" bracket insulator for T-post, U-post, and chain link fence, w/cotter pin and screw, 10/pkg.	\$10.65
DA-SNUG-SU-25	1" u-post and chain link fence insulator, yellow, 25/pkg.	10.15

For 1-3/4" to 2-1/8" wide u-posts

### DARE FENCING PRODUCTS



**Porcelain Line Insulators**

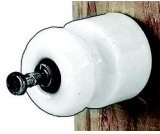

Order No.	Description	Per Pkg.
DA-16-25 .....	Std. size single groove porcelain insulator, white, 25/pkg.	\$7.85
DA-2799-25 .....	Heavy-Duty porcelain insulator with lag bolt, white, 25/pkg.	60.65



**Tubular Corner Post and End Post Insulator**

Order No.	Description	Per Pkg.
DA-1779 .....	Tubular insulator provides insulation for 90 degree turn or end loop on any style post, 19-1/2" long w/ metal insert, must be slid onto wire, molded black polyethylene, 10/pkg.	\$17.75

### Porcelain and Plastic Corner and End Insulators



1752-10



2210-10

Order No.	Description	Per Pkg.
DA-1752-10 .....	Molded high strength polymer donut style, suitable for high tensile fence, black, 10/pkg.	\$7.40
DA-2210-10 .....	Double U end and corner insulator, high strength polymer, suitable for high tensile fence, black, 10/pkg.	11.40
DA-2356-10 .....	H.D. porcelain, donut style, white, 10/pkg. (Not Pictured)	8.35

### Insulator Tubing

For use under driveways and gates.



Order No.	Description	Price
DA-2453 .....	Insulator tubing, accommodates up to 12-1/2 gauge wire, polyethylene, black, 5 ft. roll	\$15.65

### Gate Handles



503



1247



1793

Order No.	Description	Price
DA-503 .....	Plastic gate handle, red (Old Faithful)	\$2.40
DA-1247 .....	Rubber gate handle, yellow (Rub'rgate)	3.65
DA-1793 .....	H.D. molded vinyl gate handle, black (Old Ironsides)	6.65

### Equine Polywire

400 meter white polyethylene cord w/ woven U resistant polyethylene and 3 strands of stainless steel wire



Order No.	Description	Price
DA-3177 .....	Equine Polywire, 400 meter, white	\$63.50

NEW PRICES AS OF 9/10/2018

### High Tensile Fence Supplies and Accessories



2420

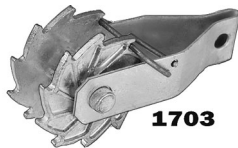

1703

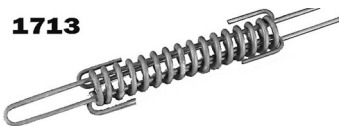

1713



2290



1701

Order No.	Description	Price
DA-1701 .....	Strainer handle for use with DA-1703 strainer, tension measuring scale on handle, zinc plated	\$9.00
DA-1703 .....	Wire Strainer / tightener, heavy cast clog w/ spring loaded latch, zinc plated	4.65
DA-1713 .....	Tension measuring spring, keeps wire taut during temperature changes, hot dip galvanized	8.75
DA-2290 .....	9" wire cutting pliers w/ hardened jaws for cutting high tensile	37.25
DA-2420 .....	Wire dereeler / spinning jenny w/ brake pad to prevent over-running, adjusts to fit 17" to 24" I.D. coils	94.50

## DARE FENCING PRODUCTS

### Splicing Equipment - Sleeves, taps and tools

2083



2154



SPLICING SLEEVES

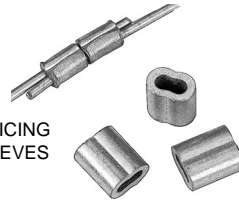

FENCE TAP

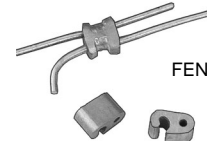

Order No.	Description	Price
DA-2083	Split bolt / line tap, used to connect hook-up or grounding wire to fence - this is not a splice, 10 / pkg.	\$20.00
DA-2154	Four slot hand crimping tool for use w/DP 1-2 thru DP 4-5 sleeves and DPT 3-4 & DPT 4-5 fence taps, 21" OAL	92.25
DA-DP 1-2/100	Splicing sleeve for 14-1/2 & 15-1/2 ga. smooth wire, 100 / pkg.	18.40
DA-DP 2-3/100	Splicing sleeve for 12-1/2 ga. smooth wire, 100 / pkg.	21.25
DA-DP 3-4/100	Splicing sleeve for 10 & 11 ga. smooth wire, 14-1/2 & 15-1/2 ga. barbed wire, 100 / pkg.	67.00
DA-DP 4-5/100	Splicing sleeve for 9 ga. smooth wire, 12-1/2 & 13-1/2 ga. barbed wire, 100 / pkg.	82.50
DA-DPT 3-4/10	Fence tap used to connect 12-1/2 - 14 ga. fence wire to 12 - 14 ga. hook-up wire, 10 / pkg.	5.71

### Miscellaneous Fencing Accessories

1360



2199



3001



482-3  
483-4



485-1

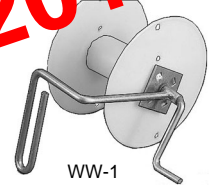

WW-1

Order No.	Description	Price
DA-1360	Multi-light graduated electric fence tester shows how many volts are at the charger or on the fence wire voltages are marked on the case from 600 to 7000 volts	\$16.75
DA-2199	Double throw electric fence switch for outdoor use, install several in each electric fence to switch off areas for testing and to allow repairs	15.15
DA-221	Single throw electric fence switch (same description as double throw switch) (Not Pictured)	12.75
DA-3001	20-1/2" fencing pliers w/ hammerhead, wire cutter and staple puller. (Will not cut high tensile wire)	17.00
DA-482-3	3 prong weed chopper to fit weed chopper-type electric fences	20.65
DA-483-4	4 prong weed chopper to fit weed chopper-type electric fences	21.25
DA-485-1	1 amp fencer fuse, 1/4" x 1-1/4", 5/pkg.	2.90
DA-WW-1	Hand-held wire and polytape winder, capacity = 22 lbs. of steel wire or 1/4 mile of polywire or tape, includes spool	26.65
DA-EFS-1	Extra poly spool for DA-WW-1 winder, 4" wide x 6-1/2" O.D. (Not Pictured)	7.25

### DARE LIVESTOCK TANK FLOAT VALVES

Universal farm tank watering valves convert tanks or barrels into automatic stock waterers. Requires little attention and keeps open tanks filled with fresh water. Adjustable to several heights, they are easily installed by hanging plated brackets over edge of tank. Brackets for Poly tanks included as well. Designed to operate from gravity flow or up to 70 PSI.

Order No.	Description	Price
DA-798	300 g.p.h. plastic housed float valve	\$14.75
DA-1780	300 g.p.h. aluminum housed float valve	24.40
DA-1800*	300 g.p.h. aluminum housed, non-siphoning float valve	32.40
DA-2175*	300 g.p.h. plastic housed, non-siphoning float valve	23.50
DA-1041	Replacement Float Ass'y	6.00

\*Complies with basic anti-siphoning regulations.



1780



798



1800



2175

# MARADYNE Cab Heaters

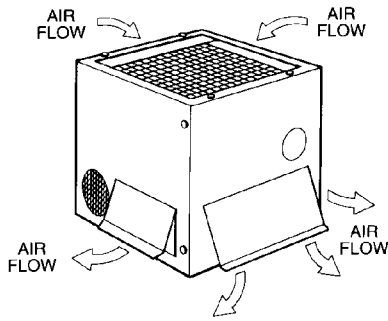

### MODELS 5001 & 8100 (12 Or 24 Volt)

Popular heater for truck, tractor, cab, etc. Provides windshield defrosting with optional defroster kit. Air enters top, heated air exits thru three adjustable doors on front and two 1-3/4" defroster holes. Mounting studs & water hose connectors at rear.

### MODEL 5001 SPECIFICATIONS

12,500 BTU per hour output\*. 130 CFM heater air capacity. 35 CFM defroster air capacity. Power requirements: 1.5A @ 12V, 7.5A @ 24V. 6-7/8" high, 6-7/8" wide, 7-1/4" deep.

### MODEL 8100 SPECIFICATIONS

Same basic design as model 5001, except higher output and slightly larger size. 20,000 BTU per hour output\*. 250 CFM heater air capacity. 60 CFM defroster air capacity. Power requirements: 5A @ 12V, 2.5A @ 24V. 8-1/8" high, 8-1/2" wide, 8-1/8" deep.

\* All heaters are rated at 150 degrees F. temperature differential. 180 degrees water temperature. 30 degrees ambient air temperature.

### A Complete Heater Requires:

1 Heater, 1 w/3' Harness, 1 Installation Kit

No.	Description	Price
MH-5001-12 ...	Heater Only (12 Volt) .....	\$181.82
MH-5001-24 ...	Heater Only (24 Volt) .....	225.20
MH-8100-12 ...	Heater Only (12 Volt) .....	281.00
MH-8100-24 ...	Heater Only (24 Volt) .....	281.00
MH-64006 .....	Installation Kit w/5/8" x12' Hose ....	85.25
MH-5670004 ..	Switch Kit w/3' wire harness .....	50.35
MH-601-70 .....	Defroster Kit .....	98.78

### PARTS FOR HEATERS (12 & 24 Volt)

MH-61316 .....	356, 5001 Core Assembly .....	169.50
MH-60339G1 ..	556, 8100 Core Assembly .....	139.80
MH-60000G2 ..	356, 5001 Fan Assembly .....	15.30
MH-60590G3 ..	556, 8100 Fan Assembly .....	15.30
MH-61319 .....	5000 Fan Assembly .....	11.70
MH-62321G1 ..	3 Spd. Switch Only (12V & 24V) ...	14.21
MH-4670215 ..	3 Spd. 12V Motor Only .....	97.50
MH-4670216 ..	3 Spd. 24V Motor Only .....	97.50
MH-53005 .....	356 Motor 12V (Old Style) .....	73.50
MH-62005 .....	556 Motor 12V (Old Style) .....	79.00
MH-62006 .....	556 Motor 24V (Old Style) .....	86.10
MH-61661G2 ..	556 Switch 12V & 24V (Old Style)	35.60

Dealer Schedule.....152

ALL PRICES SUBJECT TO CHANGE WITHOUT NOTICE.

# HEATER HOSE

Sold Only In  
25 ft. Lengths



Can be used on the following: cars, trucks, tractors and combines. Remains flexible at low temperature. Available in 5/8", 22 lbs. per 100 ft. and 3/4", 26 lbs. per 100 ft.

No.		Per Ft.
HH-581 .....	5/8" x 1 Braid Heater Hose .....	\$1.51
HH-341 .....	3/4" x 1 Braid Heater Hose .....	1.91

Dealer Schedule.....203

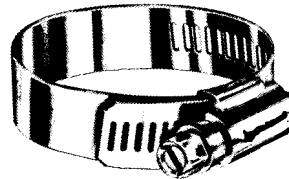

# WORM DRIVE HOSE CLAMPS

Sold Only In Full Packages!

No.	Min. Dia.	Max. Dia.	Band Width	Pkg. Qty.	Each
HC-04 .....	1/4" .....	5/8" .....	5/16" .....	10 ...	\$ .79
HC-06 .....	5/16" .....	29/32" .....	5/16" .....	10 ...	.79
HC-08 .....	7/16" .....	29/32" .....	1/2" .....	10 ...	.80
HC-10 .....	9/16" .....	1-1/16" .....	1/2" .....	10 ...	.83
HC-12 .....	11/16" .....	1-1/4" .....	1/2" .....	10 ...	.86
HC-16 .....	3/4" .....	1-1/2" .....	1/2" .....	10 ...	.86
HC-20 .....	13/16" .....	1-3/4" .....	1/2" .....	10 ...	.86
HC-24 .....	1-1/16" .....	2" .....	1/2" .....	10 ...	.86
HC-28 .....	1-5/16" .....	2-1/4" .....	1/2" .....	10 ...	.92
HC-32 .....	1-9/16" .....	2-1/2" .....	1/2" .....	10 ...	.92
HC-36 .....	1-13/16" .....	2-3/4" .....	1/2" .....	10 ...	1.16
HC-40 .....	2-1/16" .....	3" .....	1/2" .....	10 ...	2.10
HC-48 .....	2-9/16" .....	3-1/2" .....	1/2" .....	10 ...	2.32
HC-64 .....	3-9/16" .....	4-1/2" .....	1/2" .....	10 ...	2.60

Dealer Schedule: Full Package ..... 504



# Lower Radiator Hose Heaters

Caution: Not recommended for any engine unless specifically listed in application guide. Do not use on flexible wire reinforced hose.

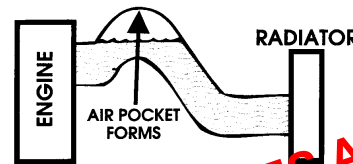
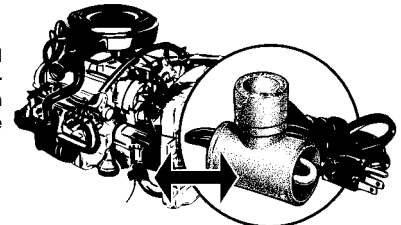

WARNING: Do not use on lower hose which enters the engine lower than the highest point of the hose.

Fast easy installation. Thermostatically controlled. Cords permanently attached for best electrical connection. Includes two gear type hose clamps.

No.	Hose Dia.	Watts	Volts	Price
K-14500 .....	1-1/4" .....	600 .....	120 .....	\$52.20
K-14600 .....	1-1/2" .....	600 .....	120 .....	52.20
K-14700 .....	1-3/4" .....	600 .....	120 .....	52.20
K-14800 .....	2" .....	600 .....	120 .....	56.10

Dealer Schedule....See Next Page For KATS Schedule

NEW PRICES AS OF 4/5/2018

NEW PRICES AS OF 4/5/2018

# Magnetic Heaters

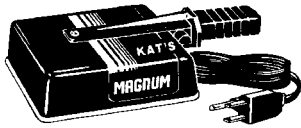

K-1160



K-1153

**Applications include:** Oil Pan, intake manifold, battery holder or engine block. Snowblowers, chain saws, snowmobiles, or other small engines. May be used for warming hydraulic systems or thawing frozen locks, pipes, gutters, livestock feeders, etc. **The Magnum** features two powerful magnets and an expanded heating surface. It can be used in many of the same applications as Handi-Heat, plus its larger size makes it ideal for use on trucks, diesels and farm machinery. Cord 4 ft.

No.	Heating Area	Watts	Volts	Price
K-1153	3-3/4" x 2-1/4"	200	110	\$71.95
K-1160	5" x 4"	300	110	112.25



# Tank-Type Engine Heaters



Circulate warmed engine coolant through engine. Preheating engines means instant starting, longer life and better service. Faster defroster and heater action. Thermostatically controlled external type. Fits most liquid cooled engines. Equipped with check valve. All connections are 5/8" & 3/4".

No.	Cooling System Capacity	Watts	Volts	Price
K-13080	Up to 18 Quarts	500	120	\$108.90
K-13100	16 to 25 Quarts	1000	120	108.90
K-13150	26 to 40 Quarts	1500	120	125.40
K-13200	41 to 60 Quarts	2000	120	190.35
K-1225	Over 50 Quarts	2500	240	122.00

No.	Description	Size	Price
K-22500	Pad Style Battery Heater, 60W	8 5/8" x 11.5"	\$26.10
K-24100	Hot Pad Oil Pan Heater, 100W	4" x 5"	41.25
K-24150	Hot Pad Oil Pan Heater, 150W	4" x 5"	48.50
K-24250	Hot Pad Oil Pan Heater, 250W	4" x 5"	103.60
K-24500	Hot Pad Oil Pan Heater, 500W	5.5" x 8.5"	126.15



Use as Oil Pan heater, Transmission Pan heater



NEW PRICES AS OF 4/5/2018



# Frost Plug Engine Heaters

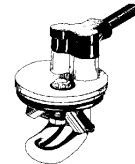

No.	Old #	Model Application	Watts	Plug Size	Price
<b>John Deere</b>					
K-11409	K4FR	50, 60, 70, 730, A, B, D, G	400	3/4" NPT	\$46.75
K-30602		All tractors since 1976 with large hex plug outside engine	1000	1-5/8" NPT	163.30
K-30603	K10J	4230, 4430, 4630, 6030, 7020, 7250 (w/ Smooth Bore Frost Plug Hole) 3020, 4000, 4320, 4520, 4620, 4640, 6404, 6466, 6619	1000	2" Rd.	80.40
<b>Ford</b>					
K-10609	K7FR	(1968-1970 3000, 4000, 5000, 8000, 9000)	600	1-3/4" Rd.	32.70
K-10610	K7GR	(1971 & Newer 3000, 4000, 5000, 7000, 8000, 9000)	600	1-1/2" Rd.	32.70
<b>IHC</b>					
K-10603	K6L	(All 460, 660, 706, TD62, TD92), (1963-1967 806, 1206), (1964 & Later 504 (153G & 188D)), (1964 & Later 606 (221G & 236D))	600	1-5/8" Rd.	32.70
K-30108		830	1000	2-1/4" Rd.	102.40
K-30501	IH1	966, 1066, 1086, 1466	750	1-1/4" Rd.	54.30
K-30502		966, 1066, 1086, 1466	1250	1-1/4" Rd.	81.55
<b>Massey Ferguson</b>					
K-10603	K6L	All 445P, 333, 444, 555, 88 (40HV)	600	1-5/8" Rd.	32.70
K-30501	IH1	All 35, 50, 150, 203, 205, 235, 2135, 2200 (AD3-152), 175, 180, 265 (AD4-236), 1100, 1105, 1130, 1135 (A6-354)	750	1-1/4" Rd.	54.30
K-11409	K4FR	90, 1080, 1085, 285 (A4-300), 65, 302, 304, 165, 255, 365, 3165, (AD4-203)	400	3/4" NPT	46.75
K-28216		Replacement Cord, 5 ft. long, for #K-11409			28.80
K-28500		Replacement Cord, 5 ft. long, for #K-30501			27.18

DEALER SCHEDULE ON KAT'S HEATERS: 1 TO 4.....152 5 TO 11.....203 12 OR MORE.....253  
(Quantities May Be Assorted)

# Femco Custom Fit Weatherbrakes

**Custom Fit:** Tailored to the make and model of tractors listed for a tight fit.

**Windshield:** Rigid, clear vinyl with heavy steel frame, no loose gaps to let in cold or wind.

Windshield is plate polished, wrinkle and distortion free for maximum visibility.

**Reinforced Vinyl Laminate:** Vinyl is resistant to ripping and rotting. It is sewn with nylon thread using double lock seams in stress areas.

**Installation:** Fewer pieces and precision tooled metal parts that slip easily into place. No special tools needed.

*A Convenient Way to  
Stay Out of the Wind & Cold!*



Order No.	Description	Price
Specify .....	ALL WEATHERBRAKES .....	\$406.60
305021225 .....	Front Windshield Only (20"x25") .....	37.35
305021226 .....	Front Windshield Only (20"x32") .....	56.95
305021231 .....	Front & Side Windshield Ass'y .....	230.00
305021233 .....	Front & Side Windshield Ass'y .....	127.00
305021234 .....	Front & Side Windshield Ass'y .....	204.00
305021235 .....	Front & Side Windshield Ass'y .....	190.50
305021243 .....	Front & Side Windshield Ass'y .....	186.00
305021251 .....	Front & Side Windshield Ass'y .....	164.20
305021252 .....	Front & Side Windshield Ass'y .....	164.20
305021256 .....	Front & Side Windshield Ass'y .....	201.00
305021260 .....	Front & Side Windshield Ass'y .....	168.50
305021263 .....	Front & Side Windshield Ass'y .....	168.50
305021271 .....	Front & Side Windshield Ass'y .....	190.50
305021274 .....	Front & Side Windshield Ass'y .....	131.35
305021279 .....	Front & Side Windshield Ass'y .....	149.00
305021282 .....	Front & Side Windshield Ass'y .....	170.65
305021296 .....	Front & Side Windshield Ass'y .....	175.00
305022183 .....	Front & Side Windshield Ass'y .....	204.00
305022184 .....	Front & Side Windshield Ass'y .....	204.00

Dealer Schedule.....152

Order No.		Front Windshield Only	Front & Side Windshield Assy
<b>ALLIS CHALMERS (With/Without 2 Post ROPS)</b>			
307020900+ .....	WD & WD45 (Rear Entry) .....	305021225 .....	305021251
307021122 .....	D-17 (1958-59-60-61 & 62 Gas) .....	305021225 .....	305021252
307021186 .....	D-17 Series III & IV (Gas & Diesel) .....	305021225 .....	305021243
307021412 .....	170 & 175 (Gas & Diesel) .....	305021225 .....	305021252
307021422 .....	190, 190XT & 200 (Gas, Diesel & LPG) .....	305021225 .....	305021252
<b>CASE (With/Without 2 Post ROPS)</b>			
307021338 .....	930, 931(Diesel), 940, 941 (Gas & LPG) (Serial #8253501 and up), 1030, 1031 Diesel .....	305021225 .....	305021252
307021341 .....	731, 731c, 831, 831c (Diesel), 741, 741c, 841, 841c (Gas), 730 & 830 (serial #8253501 & up) .....	305021225 .....	305021252
307021432 .....	770, 870, 970, 1070, 1170, 1175 Row Crop (Gas & Diesel) .....	305021225 .....	305021282
307021485 .....	1490, 1690 Low Platform, Upright Exhaust .....	305021226 .....	305021231
307052286 .....	C Series (Black Vinyl) .....	305021226 .....	305021231
307052287 .....	CX Series (Black Vinyl) .....	305021226 .....	305021231
<b>CASE IH (With/Without 2 Post ROPS)</b>			
307022104 .....	5120, 5130, 5140 (Maxxum) (with/without loader) .....	305021226 .....	305021279
<b>CASE/DAVID BROWN (With/Without 2 Post ROPS)</b>			
307021451 .....	880, 885, 990, 995, 4600 (1965 to Date) .....	305021226 .....	305021256

+ Rear Entry Models  
ROPS = Roll Over Protection System

(Continued of the next page.)

# Femco Custom Fit Weatherbrakes

Order No.		Front Windshield Only	Front & Side Windshield Assy
<b>CENTURY / BRANSON (With/Without 2 Post ROPS)</b>			
307022150	2028, 2535, 3035, 3040, 3045, Branson: 2910i, 3820i, 4220i, 4720i, BL20A loader, 3510i BL10A	305021226	305022183
<b>JOHN DEERE (With/Without 2 Post ROPS (Unless Indicated))</b>			
307020982+	50, 60, 70, 520, 620, 720 (Distillate & Gas) Rear Entry	305021225	305021251
307021094+	530, 630, 730 (LPG, GAS, Diesel) With electric starter Rear Entry	305021225	305021251
307021317+	2510, 2520, 3010, 3020, 4000, 4010, 4020, (2510, 2520 requires kit#1278 to install rear entry) (NOT 4010 2003 model year)	305021225	305021251
307021425	4520, 4620 (Gas, Diesel, LPG)	305021225	305021252
307021436	2510, 2520, 3010, 3020, 4000, 4010, 4020, 4320 (2510, 2520 requires kit#1278 to install) (NOT 4010 Compact 2003 model year)	305021225	305021252
307021443	4030, 4040, 4050, 4055, 4230, 4240, 4250, 4255, 4430, 4440, 4450, 4455, 4555, 4630, 4640, 4650, 4755 (For Tractors WITHOUT 4-Post ROPS and rigid steering columns only)	305021225	305021252
307021470	820, 830, 920, 1020, 1140, 1840, 2050, 1120, 1520, 1530, 2020, 2030, 2120, 2630 (RU, HU, LU) 1030, 1630, 1830 & 1976 Models; 2040, 2240, 2440 & 2640 New Generation Models; 1140, 1840, 2050, 2150, 2155, 2350, 2355, 2550, 2555, 2750, 2755 Low Platform Models; Canadian 1130; Will not fit 140 series loaders	305021225	305021243
307021471	1050	305021225	305021282
307021475	2840, 2940, 2950 (2955 with rigid steering only) Canadian 3130, 3140	305021225	305021282
307021476	2750 2755 High Platform	305021225	305021252
307021477	850, 950 Up or Down Exhaust & Power Steering	305021225	305021282
307021482	650, 750 Up Exhaust Only, not w/loader	305021225	305021282
307022008	655,755, 855	305021226	305021235
307022022	2955, 3150, 4030, 4040, 4050, 4055,4 230, 4240, 4250, 4255, 4430, 4440, 4450, 4455, 4555, 4630, 4640, 4650, 4755 (ALL WITH 4-POST ROPS & JD CANOPY RE 19445)	CALL	CALL
307022097	870 970 1070 (With/Without loader)	305021225	305021282
307022125	5200, 5300, 5400, 5500 (2WD or 4WD w/wo JD 500 series loader) 5210, 5310, 5410 (NOT 5510 or 20 series)	305021226	305021231
307022131	6200, 6300 & 6400 High & Low Platform (Not 10 or 20 Series)	305021226	305022183
307022141	4200, 4300, 4400, 4500, 4600, 4700 & 10 series	305021226	305022183
307022143	JD Advantage Series 6405, 6605, 7405(BLK)	305021226	305022183
307022146	2210 Black Vinyl Only (NOT the 2305)	305021226	305022183
307022147	JD 4100 (Blk Vinyl Only) Not 4110 or 4105	305021226	305022183
307022161	5320, 5220 (Not Narrow Series), Blk Vinyl, Up/Down Exhaust (Not high platform, works on straddle mount) Year 2005 or older only	305021226	305022183
307022176	JD 3120, 3320, 3520, 3720 (w/wo 300x loader)	305021226	305022183
307022529	JD 5103, 5203, 5303 & 5403 (Not 5603)	305021226	305022183
<b>FORD (With/Without 2 Post ROPS)</b>			
307020914	8N (Not on Jubilee)	305021225	305021252
307021080	600, 800 (All) 2000, 4000 All Purpose 1964 & Prior	305021225	305021252
307021457	2000, 2100, 2600, 3000, 3100, 3600, 4000SU, 4600SU, All Purpose 1965 & Up	305021225	305021274
307021458	5000, 5100, 5600 (LA-1), 6600 (EA-1),7000, 7100, 7600 (FA-1) All Purpose	305021225	305021271
307021459	4000, 4100, 4600 (DA-1 All Purpose) (NOT Power Shift)	305021225	305021271
307021467	6700, 7700, TW10, TW20 (Flat Deck or Row Crop)	305021225	305021260
307022101	1720, 1920, (w/wo loader) (Not w/shuttle trans)	305021226	305021279
307022121	5640, 6640, 7740 (S, SL) w/wo 7411 loader(Low Platform only)	305021226	305022183
307022136	3430, 3930, 4630, 5030 (w/wo loader ,shell or high top fenders)	305021226	305022183
307022142	TC25/25D, TC29/29D, TC33/33D, TC35/35D, TC40/40D, TC45/45D (w/wo loader) Not DA,DX OK	305021226	305022183
307022145	TN65, 70, 75, JX65, (Not JX75)	305021226	305022183
307022178	TL80A, TL90A, TL100A W/WO LOADER	305021226	305022183

+ Rear Entry Models  
ROPS = Roll Over Protection System



# Femco Custom Fit Weatherbrakes

Order No.		Front Windshield Only	Front & Side Windshield Assy
<b>INTERNATIONAL (With/Without 2 Post ROPS)</b>			
307021012+	H & Super H, M& Super M, MD & Super MD, Super MTA, MDTA & Super MDTA, 300, 350, 400, 450 (Diesel & Gas)	305021225	305021251
307021072+	F460, F560 (Gas & Diesel& LPG)	305021225	305021251
307021331	F706, F806, F1206 (Gas, Diesel, LPG) Not Flat Fenders	305021225	305021252
307021421	F544, F656, F666, F686, Hy-Dro 70, 86 Includes Hydrostatic & Hi-Clear (Gas & Diesel)	305021225	305021252
307021429	F756, F826, F856, F1026, F1256, F1456, Includes Hydrostatic (Gas & Diesel)	305021225	305021282
307021439	F766, F966, F1066, F1466, F1566, Hydro100 Includes Hydrostatic (Gas & Diesel) Not 4-Post ROPS	305021225	305021282
307021440	I-454, I-464, I-574 ,I-674 Includes Hydrostatic (Gas & Diesel)	305021225	305021233
307022005	I-484, I-584, I-684, I784, H84, 884, 485, 585, 685, 885, 895 (Not 695)	305021225	305021282
<b>LAWN &amp; GARDEN UNIVERSAL</b>			
307022003	Fits 16 to 19 HP Must have flat fenders & footrests. Single brake pedal. No levers or boxes on fenders. Not the JD 318, 332, 400 Series	305021226	305021234
<b>MASSEY FERGUSON (With/Without 2 Post ROPS)</b>			
307021187	50, 60 (Matic Row Crop or Hi-Arch) (Gas, Diesel, LPG)	305021225	305021252
307021370	165 Row Crop & Std w/upright exhaust front of manifold (Gas, Diesel) Flat fenders only	305021225	305021252
307021455	255, 265, 275, 285 (Gas, Diesel, up or down exhaust)	305021225	305021271
307022000	240, 250	305021226	305021279
307022095	362, 375, 383, 390, 398 w/wo loader up exhaust only on left side	305021226	305022184
307022124	1125, 1140, 1145, 1240, 1250, 1260, 1433V, 1440V, 1433, 1440, 1429 (w/wo loader 1246) AGCO ST35x, ST40x, ST35 w/ L serial# & up, Challenger MT265, MT275, MT285 (w/wo loader) Not isolated deck, Not 1155/1455	305021226	305022183
307022172	AGCO GT series (307425330 Agco#)	305021226	305022183
307022173	MT295, MT297, MF1445, MF1455 & ST45 (307425331)	305021226	305022183
307022174	Fits 431,461 (Agco # 307425333)	305021226	305022183
307022175	MF1533, 1540, 1635,1643, 1648, 1652, 1655, 1660 AGCO ST34A, ST41A, Challenger MT265B, MT275B, MT285B (w/wo ML40B loader)	305021226	305022183
<b>MINNEAPOLIS MOLINE, OLIVER, WHITE, COCKSHUTT (With/Without 2 Post ROPS)</b>			
307021081+	Oliver 77, 88, 770, 880. Cockshutt 700 (Row Crop)(G&D)	305021225	305021251
307021325	Oliver & Cockshutt 1750,1800, Series C, 1850, 1950 Row Crop (G&D) (Adj. Steering Wheel)	305021225	305021252
307021460	Oliver & Cockshutt 1550, 1555, 1600, 1650, 1655; White 2-70; Minn. Moline-G-550, G-750 (Std. & fuel top fenders)	305021225	305021252
307021461	Oliver & Cockshutt 1755, 1855,1955(Row Crop); White 2-85, 2-105; Min.Moline G850, G940 (Std. & Fuel top fenders)	305021225	305021282
307022103	White 60 & 80 HP American Series (w/wo loader)	305021226	305021231
<b>KUBOTA (With/Without 2 Post ROPS )</b>			
307552123	L2900, L3010, L3300, L3410, L3600, L3710, L4200, L4310, L4610, Grand L Series(Works w/Kubota loader ONLY) Orange	305021226	305022183
307022144	M4900, M5700, M6800, M8200, M9000, M5700SD N, M8500SDNB (With Kubota Loader ONLY)	305021226	305022183
307022185	"B" Series: B7410, B7510, B7610, B7800, B2630	305021226	305022183
307022186	"BX" Series: BX1500, BX1830, BX2230, BX2350, not BX23, Not BX24	305021226	305022183
<b>ZETOR (With/Without 2 Post ROPS)</b>			
307872151	3320, 3340, 4320, 4340, 6320, 6340,7320,7340 (Black Vinyl)	305021226	305022183
307872152	3321, 3341, 4321, 4341, 6321, 6341, 7321, 7341 (Black Vinyl)	305021226	305022183

+ Rear Entry Models

ROPS = Roll Over Protection System

**DUO-GRIP  
TIRE CHAINS**

For off road use only!

Factory Warranty is void if used on concrete or solid surfaces.



**Laclede  
Tractor  
Tire Chains**



**Roadmaster  
TIRE CHAINS**

Tire Chain No.	Wt.	List Per Set	Use Cross Chain No.
DUO-214 -- 116		\$713.42	-- DUO-292
DUO-218 -- 152		803.00	-- DUO-293
DUO-226 -- 122		644.61	-- DUO-292
DUO-225 -- 109		670.52	-- DUO-293
DUO-229 -- 132		697.40	-- DUO-293
DUO-240 -- 143		879.45	-- DUO-295
DUO-242 -- 152		802.97	-- DUO-294
DUO-246 -- 181		943.52	-- DUO-294
DUO-250 -- 158		971.63	-- DUO-295
DUO-252 -- 173		1064.00	-- DUO-295
DUO-254 -- 196		1205.25	-- DUO-296
DUO-260 -- 164		1008.51	-- DUO-296
DUO-262 -- 170		1045.39	-- DUO-297
DUO-263 -- 143		842.48	-- DUO-297
DUO-264 -- 135		717.90	-- DUO-298
DUO-266 -- 187		988.07	-- DUO-297
DUO-268 -- 171		903.47	-- DUO-298
DUO-270 -- 203		1058.30	-- DUO-297
DUO-271 -- 190		1162.35	-- DUO-298
DUO-272 -- 225		1383.57	-- DUO-298
DUO-273 -- 209		1272.77	-- DUO-298
DUO-276 -- 259		1592.82	-- DUO-299
DUO-277 -- 261		1605.10	-- DUO-298
DUO-282 -- 270		1691.74	-- DUO-302

**DUO-Grip  
CROSS CHAINS**

Cross Chain No.	Chain No.	Size	Links	List Each
DUO-292	-- 9/0	-----	9	\$41.20
DUO-293	-- 9/0	-----	10	43.30
DUO-294	-- 9/0	-----	11	44.70
DUO-295	-- 9/0	-----	12	49.10
DUO-296	-- 9/0	-----	13	57.40
DUO-297	-- 9/0	-----	14	57.20
DUO-298	-- 9/0	-----	17	62.80
DUO-299	-- 9/0	-----	19	82.70
DUO-302	-- 9/0	-----	22	81.00

**Roadmaster  
CROSS CHAINS**

Cross Chain No.	Chain No.	Size	Links	List Each
RM-6434	--- 9/0	-----	11	12.58
RM-6445	--- 9/0	-----	14	18.45
RM-7420	--- 9/0	-----	16	21.40
RM-7426	--- 9/0	-----	19	24.10
RM-9562	--- 11/0	-----	17	39.80

Tire Chain No.	Wt.	List Per Set	Use Cross Chain No.
RM-0822 ---- 68		\$409.88	-- RM-6434
RM-0829 ---- 56		337.54	-- RM-6434
RM-0832 ---- 73		446.19	-- RM-6434
RM-0836 ---- 86		518.39	-- RM-6445
RM-0838 ---- 99		596.71	-- RM-6445
RM-0846 ---- 120		597.75	-- RM-6445
RM-0850 ---- 79		476.16	-- RM-6445
RM-0852 ---- 91		548.55	-- RM-6445
RM-0856 ---- 104		627.04	-- RM-6445
RM-0858 ---- 108		650.96	-- RM-7420
RM-0862 ---- 126		664.32	-- RM-6445
RM-0859 ---- 114		699.17	-- RM-7420
RM-0866 ---- 144		724.77	-- RM-7420
RM-0869 ---- 122		735.00	-- RM-7420
RM-0874 ---- 127		765.93	-- RM-7426
RM-0876 ---- 133		819.72	-- RM-7426
RM-0877 ---- 142		715.45	-- RM-7426
RM-0879 ---- 151		766.52	-- RM-7426
RM-0883 ---- 167		994.80	-- RM-9562
RM-0884 ---- 181		1093.35	-- RM-9562
RM-0885 ---- 191		1181.54	-- RM-9562
RM-0887 ---- 211		1229.85	-- RM-9562
RM-0889 ---- 222		1356.56	-- RM-9562
RM-0894 ---- 250		1465.02	-- RM-9562

**NEW PRICES AS OF 10/20/2020**

Dealer Schedule:

1 Pair.....203      2-3 Pair.....203 & 101  
4 Pair Or More.....604      Cross Chains.....203

**ALL COMPLETE TIRE CHAINS  
ARE SHIPPED FREIGHT PRE-PAID.**

CROSS CHAINS ARE FREIGHT PRE-PAID IF ORDERED WITH COMPLETE CHAINS.

**Laclede Tractor Tire Chain Fit Chart**

Tire Size	Roadmaster	DUO Grip	Tire Size	Roadmaster	DUO Grip	Tire Size	Roadmaster	DUO Grip	Tire Size	Roadmaster	DUO Grip
7.2-24	---- RM-0832	----- N.A.	12.4-24	---- RM-0838	--- DUO-229	14.9-28	---- RM-0869	--- DUO-252	18.4-30	---- RM-0885	--- DUO-271
8.3-24	---- RM-0822	----- N.A.	12.4-28	---- RM-0838	--- DUO-218	14.9-30	---- RM-0876	--- DUO-252	18.4-34	---- RM-0887	--- DUO-273
9.5-16	---- RM-0829	----- N.A.	12.4-36	---- RM-0862	--- DUO-232	14.9-38	----- N.A.	---- DUO-254	18.4-38	---- RM-0889	--- DUO-272
9.5-24	---- RM-0832	--- DUO-214	12.4-38	---- RM-0862	--- DUO-232	15-19.5	---- RM-0836	----- N.A.	18.4-42	---- RM-0894	--- DUO-277
9.5-28	---- RM-0836	--- DUO-214	12.4-40	---- RM-0866	----- N.A.	15.5-38	---- RM-0879	--- DUO-254	18.4-46	----- N.A.	---- DUO-277
9.5-32	---- RM-0838	--- DUO-226	12.4-42	---- RM-0866	----- N.A.	16.9-24	---- RM-0874	--- DUO-260	19.5L-24	---- RM-0883	--- DUO-268
9.5-36	---- RM-0862	--- DUO-218	12.4-48	----- N.A.	---- DUO-259	16.9-26	---- RM-0876	--- DUO-262	20.8-34	----- N.A.	---- DUO-272
9.5-38	---- RM-0862	--- DUO-218	12.5/80-18	--- RM-0832	----- N.A.	16.9-28	---- RM-0876	--- DUO-262	20.8-38	----- N.A.	---- DUO-276
10-16.5	---- RM-0829	----- N.A.	13.6-16	---- RM-0850	----- N.A.	16.9-30	---- RM-0877	--- DUO-266	20.8-42	----- N.A.	---- DUO-276
10.5/80-18	--- RM-0822	--- DUO-225	13.6-24	---- RM-0858	--- DUO-240	16.9-30	---- RM-0885	--- DUO-266	21L-24	----- RM-885	----- N.A.
11-38	----- N.A.	---- DUO-246	13.6-26	---- RM-0858	--- DUO-240	16.9-32	----- N.A.	---- DUO-266	24.5-32	----- N.A.	---- DUO-282
11.2-24	---- RM-0836	--- DUO-214	13.6-28	---- RM-0859	--- DUO-242	16.9-34	---- RM-0879	--- DUO-270	23.1-34	----- N.A.	---- DUO-282
11.2-28	---- RM-0838	--- DUO-226	13.6-36	---- RM-0866	--- DUO-246	16.9-38	----- N.A.	---- DUO-272	28.1-34	----- N.A.	---- DUO-282
11.2-32	---- RM-0846	--- DUO-218	13.6-38	---- RM-0866	--- DUO-246	17.5-24	---- RM-0874	--- DUO-263	30.5L-32	----- N.A.	---- DUO-283
11.2-34	---- RM-0846	--- DUO-224	13.9-36	----- N.A.	---- DUO-242	17.5L-24	--- RM-0874	--- DUO-263	320/85-34	----- N.A.	---- DUO-242
11.2-36	---- RM-0846	--- DUO-224	14.9-24	---- RM-0859	--- DUO-240	18.4-16.1	----- N.A.	---- DUO-264	355/80-24	-- RM-0836	--- DUO-226
11.2-38	---- RM-0862	----- N.A.	14.9-26	---- RM-0869	--- DUO-250	18.4-24	---- RM-0883	--- DUO-268	390/90-55	----- N.A.	---- DUO-255
12-16.5	---- RM-0822	--- DUO-225	380/85R24	--- RM-0859	----- N.A.	18.4-26	---- RM-0883	--- DUO-271	420/80-46	----- N.A.	---- DUO-256
						18.4-28	---- RM-0884	--- DUO-271	420/85-R30	--- RM-0885	----- N.A.

**NOTE: Because the dimensions of Agricultural and Industrial Tires vary between Tire Manufacturers and tread design profiles, it is recommended that you pre-fit chains prior to use. These chains may be designed to fit the largest tire profile within the tire size.**



# Laclede Grader & Equipment Tire Chains

**ALL COMPLETE TIRE CHAINS ARE SHIPPED FREIGHT PRE-PAID.**  
CROSS CHAINS ARE FREIGHT PRE-PAID IF ORDERED WITH COMPLETE CHAINS.

NEW PRICES AS OF 10/20/2020

Tire Sizes	Grader Chain No.	Wt.	List Per Set.	Use Grader Cross Chain
13.00-24, 13.00-25, 14.00-20, 14.00-21, 15.5-25	GE-2612	110	\$717.40	GE-6630
14.00-24, 14.00-25	GE-2615	125	809.60	GE-6630
16.00-20, 16.00-21, 17.5-25	GE-2624	157	1273.40	GE-6640
16.00-24, 16.00-25	GE-2627	181	1479.60	GE-6940
20.5-25	GE-2633	198	1564.20	GE-6650
18.00-24, 18.00-25, 18.00-26	GE-2636	211	1420.20	GE-6650
23.5-25	GE-2645	328	3152.80	GE-6660
26.5-25, 30.5R32, 710/70R 38, 755/70R25, 800/65R32	GE-2657	419	3558.20	GE-6670

**Fax Toll-Free  
1-800-342-7252**

## Grader & Equipment Cross Chains

Cross Chain No.	Chain Size	No. of Links	List Each
GE-6630	9/0 (3/8")	17	\$21.20
GE-6640	11/0 (7/16")	15	42.90
GE-6650	11/0 (7/16")	19	51.00
GE-6660	14/0 (.531)	20	100.20
GE-6670	14/0 (.531)	23	113.00

Dealer Schedule: 1 Pair.....203      2-3 Pair.....203 & 101      4 Pair Or More.....604      Cross Chains.....203

## Bead Breaker

A revolutionary hand tool that makes the dismounting of tires quick and easy.

Applies up to 5 tons of pressure on the bead.  
Portable and small enough to fit into a tool box.  
Simple to operate and comes fully assembled.

Construction uses:

backhoes, loaders and graders, skid steer loaders,  
trucks (tube type and tubeless)

Farm uses:

tractor tires (front & rear),  
implements (manure spreaders, wagon grain carts)

Other applications:

all terrain vehicles, four wheel drive vehicles, fork lifts &  
industrial mine tires, wheelbarrows and more



No.	Description	Wt.	List
MK11	Bead Breaker	9.9 lbs.	\$258.70

Dealer Schedule.....102

### Laclede Swivel Cross Chain Hook



NOTE - - - Most competitive brands of cross chains WILL NOT FIT Laclede Swivel hooks. But Laclede Swivel hooks and cross chains CAN BE USED as replacement on most other brands of tractor chain.

No.	Each
7990-451-25..... Cross Chain Swivel Hook .....	\$4.60

Dealer Schedule.....103



### Laclede Cross Chain End Hooks

Order No.	Size	Description	Each
7901-290-02 .....	3/8" .....	H.D. Truck Chain Hook .....	\$2.10
7901-320-02 ....	13/32" ...	Tractor Chain Hook .....	2.60
7901-317-02 .....	7/16" ....	Roadmaster Hook .....	4.60

Dealer Schedule.....103

### Laclede Hardened Cross Chain

**Sold In Standard 25' Lengths Only!**



Order No.	Size	Wt. Per C/Ft.	Price Per Ft.
2563-500-25 .....	9/0 (3/8" Round) .....	115 lbs. ....	\$9.88
2569-502-25 .....	11/0 (7/16" Round) .....	180 lbs. ....	16.64

2964-512-25 .....	9/0 (3/8" Straight) .....	160 lbs. ....	18.90
-------------------	---------------------------	---------------	-------

Dealer Schedule.....103

### Laclede Welded Side Chain

**Sold In Standard Lengths Only!**

Polished Non-Hardened



No.	Size	Wt. Per C/Ft.	Per Ft.
2256-500-02 .....	7/0 (5/16") .....	66 lbs. ....	\$4.90
2263-512-02 .....	9/0 (3/8") .....	104 lbs. ....	5.65
2269-512-02 .....	11/0 (7/16") .....	140 lbs. ....	8.22

Standard Length 25'

Dealer Schedule.....103

### Laclede Tire Chain Repair Pliers

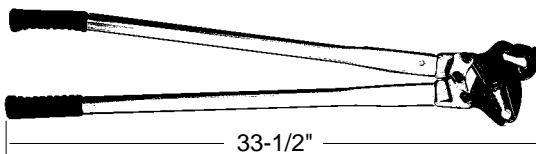

Order No.	Each
7017-302-23..... Tire Chain Repair Pliers .....	\$305.70

Dealer Schedule.....103

### Laclede

### Side Chain Fasteners

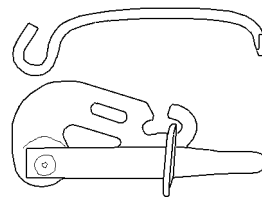

For DUO & Swivel

For Roadmaster

Order No.	Each
7015-310-02 .....	Fastener f/Swivel & DUO .....
6804-714-02 .....	Fastener f/Roadmaster .....

Dealer Schedule.....103

All Laclede items on This Page Are Freight Pre-Paid If Ordered With Complete Tire Chains.

**Shipping Over 95%  
Of Our Orders  
The Same Day!**

## Weather Station

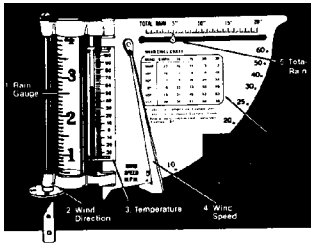

Outdoor, Rain/Wind/Temperature. Single unit mounts outdoors and indicated temperature, wind speed, wind direction, and actual rainfall as collected in glass measuring tube. Cumulative rainfall up to 20 inches can be marked with pointer. Wind chill chart included. Approx. Dimensions (HxHxD) 5" x 5" x 1-1/2"

No.	Price
1283 ..... Weather Station .....	\$9.90
1284 ..... Rain Gauge Vial Only .....	1.56

Dealer Schedule:  
 1 to 5.....152    6 or more.....203  
 Rain Gauge Vial.....152

## Purolator Polyfiber Air Filters premium quality

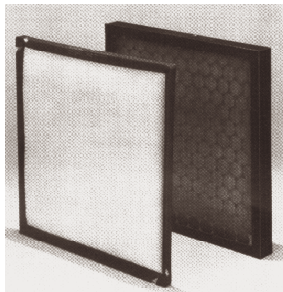

Purolator Polyfiber filters are produced using specially developed polyester fibers bonded together to form an interlocking pattern of tiny lint and dust traps. Dust loading is accompanied by a uniform buildup in resistance. Media is designed to minimize surface loading.

The Purolator Polyfiber frame is constructed of heavy duty kraft board. Purolator's monobond seal provides a strong unitized bond for residential, commercial, or light industrial use.

**Purolator Polyfiber filters provide superior performance where large quantities of lint and dust predominate.** Rugged construction has made this an industry leader as a pre-filter for higher velocity systems.

**Stock Sizes: 16x20x1, 16x25x1, 20x25x1**

**Sold in Cartons Of 12 Only!**  
**Call for availability of other sizes!**

No.	Each
P312-(Specify HxWx1) .. Polyfiber Air Filter .....	\$2.99

Dealer Schedule.....152



## "E-Z READ" Jumbo Rain Gauge

Gauge is 21" tall and its 1-3/4" clear plastic tube has brilliant yellow markings with a 2 color float. Can be read from a distance of up to 50 feet! Molded from high impact plastics and a U-V protected tube for long life. Comes completely assembled with instructions and screws for easy mounting.

No.	Price
RG-1 ..... E-Z READ Jumbo Rain Gauge .....	\$16.50

Dealer Schedule: 1 to 11.....182    12 or more.....123

## RURAL MAIL BOX & FAN MAILER

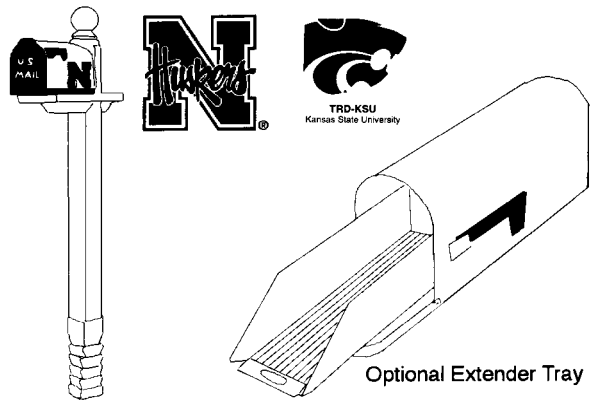

**NEW PRICES AS OF 5/16/2020**

**Mail boxes** are molded in one piece from top-grade copolymer materials. Interior strut construction for years of use and reliability. Assembled with pre-drilled holes for mounting. Color: black. Standard #1 size Dimensions: 20"x7"x10".

**Fan Mailer** box is white with black base and lid. Red and Black Nebraska "Huskers" Logo or Purple Kansas State "Wildcat" Logo on both sides.

**Extender tray** makes for easier mail retrieval and allow box to be further from the curb to reduce damage from maintenance vehicles.

Model	Description	Price
UT-R4501BL .....	Standard #1 Rural Mail Box .....	\$21.56
UT-TRD-UNE ....	"Huskers" Fan Mailer .....	33.98
UT-TRD-KSU ....	"Wildcat" Fan Mailer .....	33.98
UT-EZM-10 .....	Extender Tray f/Mail Box .....	12.32

Dealer Schedule.....152

PRICES SUBJECT TO CHANGE WITHOUT NOTICE.

Visit Us On The Web:  
[www.centraisupplyandrubber.com](http://www.centraisupplyandrubber.com)

*Centralize with Central!*  
**Call: 1-800-444-8666**

# Hypno ROLLER PUMPS

## Series 4000

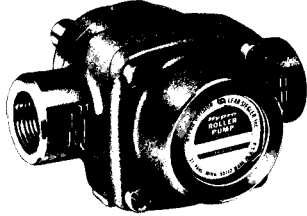

4 Roller Pump.  
Pressures to 150 PSI  
Output at 50 PSI.  
**Series 4001**  
1800 RPM=8 GPM.  
**Series 4101**  
2600 RPM=7 GPM.  
Ports=3/4" NPTF.  
Shaft=5/8" O.D.

Model	Description	Price
N4101LC	Pump, Ni-Resist, Less Coupling	\$360.36

## Series 6500

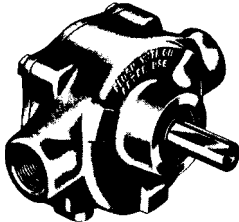

6 Roller Pump.  
Pressures to 300 PSI  
Output at 50 PSI.  
540 RPM=8.1 GPM.  
1000 RPM=16.4 GPM.  
Ports=3/4" NPTF.  
Shaft=5/8" O.D.

### For 540 RPM & 1000 RPM Tractor PTO

No.	Description	Price
N6500	Pump (Ni-Resist), Less Coupler	\$493.78
1321-0008	Quick Coupler, 1000 RPM	65.13

## Series 7700

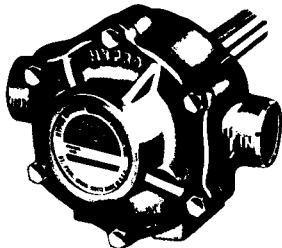

7 Roller Pump  
Pressures to 200 PSI.  
Output at 50 PSI:  
540 RPM=12.5 GPM  
Ports= 3/4" NPTF  
Shaft=15/16" O.D.

No.	Description	Price
C7700	Pump Less Coupler	\$291.02
3430-0219	Parts Kit	65.43

(Parts Kit Contains: 7 #1002-0004 poly rollers,  
1 #1720-0014 O-ring for end plate, 2 #2112-0003 Viton seals)

#### DEALER SCHEDULE:

Pumps.....253 Couplers and Parts.....33/133

# Hypno Piston Pump Series 5300

**The Small Twin**  
Outputs to 3gpm -  
Pressures to 500 psi -  
Speeds to 1800 rpm

Economical Pumps  
for Portable Car  
Wash Units.  
Excellent Pump for  
Low Cost

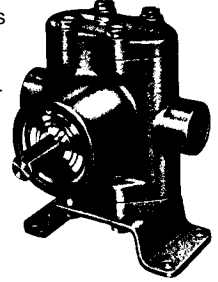

## HIGH PRESSURE PERFORMANCE

Model	Output	Shaft	Price
C5320R	2 GPM @ 1800 RPM	Solid	\$505.34
C5330R	3 GPM @ 1800 RPM	Solid	505.34

### Repair Kits Available.

Dealer Schedule.....253

## SNAP HITCH PUMP ADAPTER

1-3/8 x 6 spline Snap Hitch to Round Bore.

Round Bore  
with Keyway  
and Set Screw.

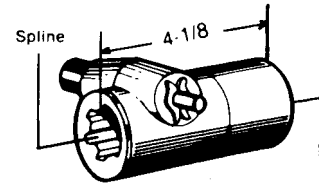

Order No.	Spline	Rd. Bore	Keyway	Price
114-1000	1-3/8 x 6	5/8	3/16	\$62.08
114-1200	1-3/8 x 6	3/4	3/16	62.08
114-1400	1-3/8 x 6	7/8	3/16 & 1/4	67.08
114-1500	1-3/8 x 6	15/16	1/4	62.08
114-1600	1-3/8 x 6	1	1/4	62.08
115-1000	1-3/8 x 21	5/8	3/16	66.30
115-1200	1-3/8 x 21	3/4	3/16	66.30
115-1400	1-3/8 x 21	7/8	3/16 & 1/4	71.38
115-1500	1-3/8 x 21	15/16	1/4	66.30
115-1600	1-3/8 x 21	1	1/4	66.30

Dealer Schedule.....203

*Centralize  
with  
Central Supply!*

**Rely on Central Supply For Fast Order Shipment!**

**CENTRIFUGAL PUMP REPAIR KIT**

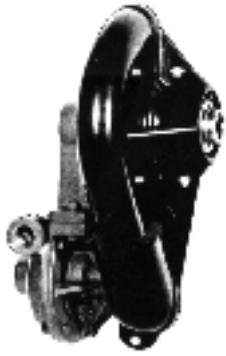

Mounts directly on tractor PTO.  
 Ace 10-groove belt drive.  
 PORTS:  
 1-1/4" Suction  
 1" Discharge

Ace PTO mounted belt drive centrifugal pump with belt and shaft guard installed.

**GREATER CAPACITY FOR AGITATION**

Straight centrifugal pump with pulleys and belts arranged for direct mounting on 1-3/8" PTO shaft. 600 & 1000 R.P.M. Pressure to 60 PSI - - - Output to 75 G.P.M.

No.	Repair Kit	Price
RK-PTOC-600-10 .....	Includes belt, seal, O-Ring Gasket ....	\$121.34
RK-PTOC-1000-10 .....	Includes belt, seal, O-Ring Gasket .....	121.34

Dealer Schedule.....33/133



**ACE HYDRAULIC MOTOR DRIVEN CENTRIFUGAL PUMP REPAIR KIT**

For ACE 204, 210, 410 Hydraulic Pumps.

No.	Price
RK-BAC-HYD .....	Hyd. Motor Repair Kit ..... \$63.65

Dealer Schedule.....253

**DELEVAN TURBO 90 PUMP**

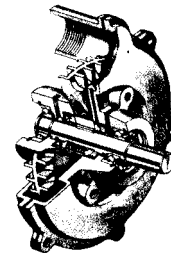
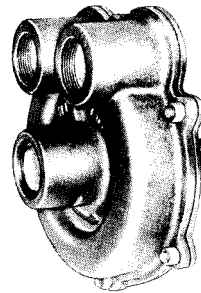

The high volume Turbo 90 pump was designed specifically for pumping wettable powders and suspensions. Capacities up to 60 GPM at 30 PSI (90 GPM at 0 PSI). It was also designed for direct drive from

a 1000 RPM PTO shaft, which means it operates at much slower speeds than centrifugal pumps.

Longer life for seals and other wearing parts. Self-flushing seal cavities virtually eliminate chances for clogging.

Ports: 1-1/2" IPTF, Specification: 50 GPM at 30 PSI, Shaft: 15/16" Diameter, Seal: Viton.

No.	Description	Price
35992 .....	1-3/4" 1000 RPM Quick Coupler .....	\$159.00
28455-1 .....	Repair Kit (Face Seals) .....	159.00
28455-2 .....	Repair Kit (Lip Seals) .....	55.86

Dealer Schedule: Pumps.....253 Parts.....33/133

*Centralize  
 with  
 Central Supply!*

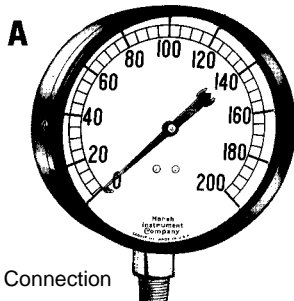

Lower Connection

**PRESSURE GAUGES**

Pressure Gauges  
 2-1/2" Dial, 1/4" MPT

**Standard Gauge Damper**



Order No.	Ref.	Description	Price
GL25-(specify) ... A .....		Lower Aluminum Connection (1/4"), (Specify - 100, 200, 400, 600 PSI) .....	\$17.50
2404-0047 .....		Damper Gauge .....	13.15

Dealer Schedule.....203

ALL PRICES ARE SUBJECT TO CHANGE WITHOUT NOTICE.

# ELECTRIC OPERATED SOLENOID VALVES.....

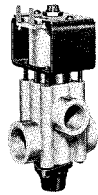

No. 144-1  
For Planters

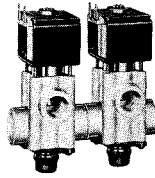

No. 144-2  
For Discs & Incorporators

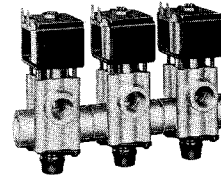

No. 144-3  
For Boom Sprayers

The No. 144 Directo Valve is specifically designed for agricultural spray boom control. It is activated by the vehicle's 12 volt DC electrical system. This permits remote locating on the sprayer and allows quick and convenient control of the spray boom.

10 GPM flow rate with 5PSI pressure drop.  
Terminals can be located at any of four positions of 90 degrees apart.  
Coil can be removed without removing valve form line.  
Valve can be manually actuated.  
Coil cover, straps, and bottom plate are epoxy painted steel.

No.		Price
144-1	..... 1 Section, 3/4" .....	\$177.62
144-2	..... 2 Section, 3/4" .....	359.83
144-3	..... 3 Section, 3/4" .....	542.08

Dealer Schedule.....152

## MODEL RC-10

12V DC Electric Pressure Regulator

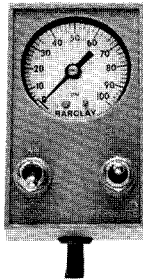

### FEATURES

- \*Remote controlled pressure regulator permits operation from inside the tractor cab.
- \*Valve is operated by a two-way electrical switch connected to any 12 Volt (DC) power source.
- \*Valve cycle from open-to-closed is 30 seconds. Any setting in between can be precisely achieved by jogging the switch forward and backward.
- \*Energy consumption is extremely low (10 milliamps.) and only when settings are being changed.

## RC-1 REMOTE CONTROL SYSTEM

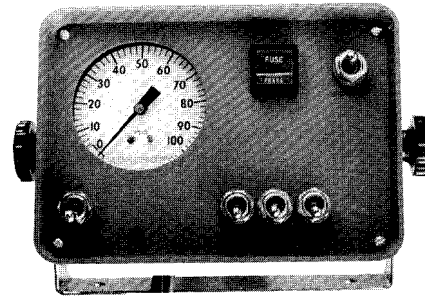

### FEATURES

- \*Constant "eyes-front" monitoring of sprayer pressure.
- \*Simple "finger-tip control" of sprayer pressure with mounted switch.
- \*Quick disconnect in system wiring harness permits permanent installation of monitor & control Module in tractor cab and permanent mounting of Control Unit on sprayer.
- \*Simple "do-it-yourself" installation.
- \*Complete - nothing else to buy - operates on any 12 volt system.

### RC UNITS INCLUDE:

Monitor, butterfly, valve & wiring. 144 solenoids are NOT included with below kits. Order Separately

No.	Soloinoids	Price
RC-10N-1	..... One .....	\$273.00

Dealer Schedule.....203

## DELEVAN NYLON MANIFOLD



With 3/4" NPTF inlet, eight 1/2" NPTF outlets and 1/4" NPTF gauge outlet.

No.		Price
36516-3	..... Nylon Manifold .....	\$23.75

Dealer Schedule.....152

**Call Toll-Free**  
**1-800-444-8666**  
**Fax Toll-Free**  
**1-800-342-7252**



**SPRAYING SYSTEMS**

**Tee Valve**

for selective control of multiple section boom sprayers

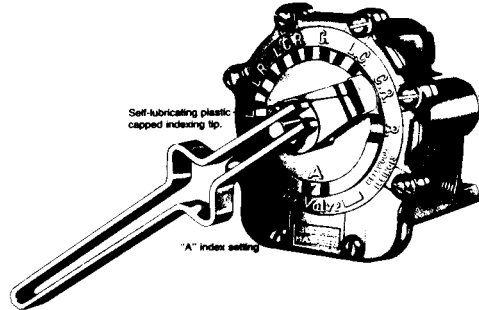

With handle in down position, selection is made of any of the seven indexed valve positions to control operation of any combination of boom sections. Handle is raised to open the valve - - - and lower again for shut-off. TeeValve has auxiliary ports for pressure gauge, pressure relief valve and spray gun connections. Body made of aluminum with stainless steel and other corrosion resistant parts. For pressures up to 300 psi.

No.	Price
17H-SPK .....	Repair Kit .....
	(\$41.17)
	(Repair Kit includes: Cotter, Rivet, Washer, Tip, Screws, Gasket, Packing, Seat.)

Dealer Schedule.....152

**PRESSURE RELIEF VALVES**

to control desired pressure settings in spray lines for assuring more uniform rates of chemical application



Pressure Up To 300 PSI

**Model 8460**  
**Diaphragm Type Relief Valves**  
 Offer maximum corrosion resistance to all farm chemicals since diaphragm seals off operating parts from liquid flow. Special diaphragm material remains resilient, assures chatter-free, responsive pressure control. Dual stainless steel internal springs.

No.	Price
8460-1/2 .....	Nylon .....
	(\$72.62)

Dealer Schedule.....203

**Rely on Central Supply For Fast Order Shipment!**

**MODEL FMK PTO-BELT DRIVE KIT**

Mounts Pump On John Deere 1000 RPM Front PTO Shaft



PTO belt Drive Includes: Brackets, sheaves, belts and cap screws, nuts washers etc. for mounting on tractor.

**FACTS ABOUT JOHN DEERE FRONT PTO**

The front PTO is available only on John Deere tractors. Front PTO operates at 1000 RPM. Both front and rear PTO may be used at the same time, but do not have to be operated at the same speeds.

No.	Each
FMK-28-2M .....	Polyflex Belt (2 Required) .....
	(\$39.00)

Dealer Schedule.....33/133



**Belts for Model #CPK Centrifugal Sprayer Pump Kit**

**FOR USE ON International Harvester PTO Driven-Cyclo Planter**

No.	Each.
CPK-28-2 ....	Polyflex Belt (2 Required) .....
	(\$39.00)

Dealer Schedule.....33/133



**Directo Valve**

**FEATURES:** Large capacity 12.5 GPM at 5 psi pressure drop. Maximum pressure of 150 psi. One-piece valve body with mounting flange for 1/4" bolts. Built-in 1/4" slots blind gauge connection.

No.	Description	Price
6B .....	One Unit DirectoValve, Poly .....	(\$58.41)

Dealer Schedule.....203

PRICES ARE SUBJECT TO CHANGE WITHOUT NOTICE.

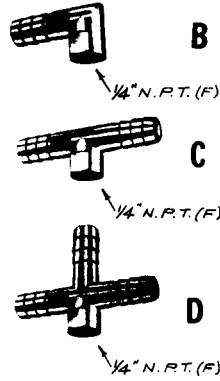
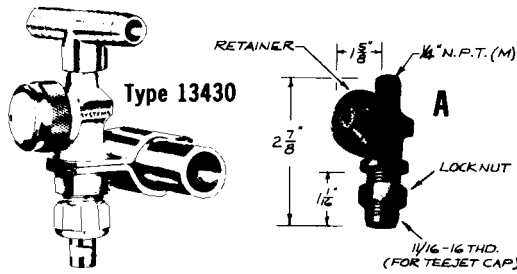

These Diaphragm TeeJet Nozzles Provide Quick Positive Shut-Off and are Recommended For Flow Rates Up To 3 GPM And Pressures Up To 125 PSI.

No.	Ref.	Description	Price
13430	A	1/4" with Lock Nut	\$16.80
13434	B	3/8" Nylon 1 Barb	3.70
13437	B	1/2" Nylon 1 Barb	3.70
13435	C	3/8" Nylon 2 Barb	3.70
13438	C	1/2" Nylon 2 Barb	3.70
13436	D	3/8" Nylon 3 Barb	3.70
13439	D	1/2" Nylon 3 Barb	3.70

Dealer Schedule.....203

**Diaphragm Check Valve Nozzles**

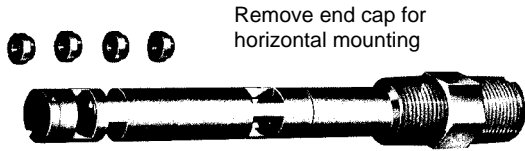

**Jet Agitator**  
Includes Four Sizes of Nozzles  
**Tank Mounted Venturi Type**

Order No.	Description	Price
3371-0019	Jet Agitator with 4 orifices	\$8.83
	Dealer Schedule.....	152



**Type 8360**

**NYLON**

**Diaphragm Check Valve**

No.	Description	Price
8360	1/4" (less Tip Cap, Strainer.) Opens at 7 PSI. Flow Rate Up To 2 GPM.....	\$15.70

Dealer Schedule.....203

**Nylon Elbow To Fit 3371-0019 Agitator**



3/4" IPTF x BARB

No.	Barb	Price
ELF3412	1/2"	\$1.89
ELF3458	5/8"	2.36
ELF3434	3/4"	2.36
	Dealer Schedule	152

**Spray Nozzle Components & Accessories**



**Type 7450 Compact**  
Double Swivel Nozzle

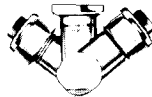

**Type 8600-2 Nylon**  
Double Swivel Nozzle

Brass No.	Inlet	Price
7450B-2T	1/8"	\$14.66
7450-2T	1/4"	14.66
Nylon No.	Inlet	Price
8600-2-18T	1/8"	\$11.70
8600-2-14T	1/4"	11.70

Note - Prices Do Not Include Tip, Strainer Assembly & Cap.

Dealer Schedule.....203

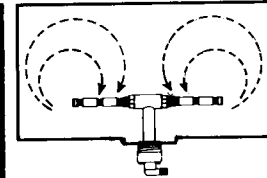

**AGITATOR TEE**

The agitator tee along with a 1-1/4"x3/4" Dbl. threaded bushing will fit into the bottom of the polyolefin tanks.

No.	Description	Price
T34-TEE	3/4" MPT x 3/4" FPT	\$8.10
BDT114-34	1-1/4" x 3/4" Double Threaded Bushing	12.25
	Dealer Schedule	152

**Nozzle Cap Adapter**

for attaching drop pipes or pipe extensions. Specify choice of 1/8", 1/4" & 3/8" NPT female outlet connections.



No.	Type	Price
4676-BR	Brass	\$3.19
4676-NY	Nylon	2.62

Dealer Schedule.....203

**Nozzle Blanks**



No.	Type	Price
3942-BR	Brass	\$ .33

Dealer Schedule.....203

PRICES ARE SUBJECT TO CHANGE WITHOUT NOTICE.



**Spray Nozzle  
Components & Accessories**



**Winged Cap**  
Can be hand tightened

#18032 Winged Cap

\$1.30

Tip NOT Included

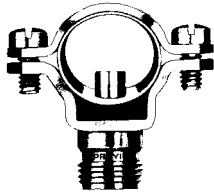

**TYPICAL  
TeeJet  
ASSEMBLIES**

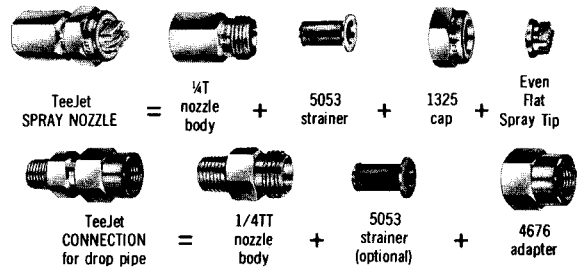

**TEEJET SPLIT - EYELET BODY ASSEMBLIES**

**Part No.**

TeeJet	Size	Material	Price
7421-BR12	1/2"	Brass	\$12.20
7421-NY12	1/2"	Nylon	6.05
7421-BR34	3/4"	Brass	12.20
7421-BR100	1"	Brass	12.20

Note - - Cap & Tip NOT Included.

**TeeJet Body Only.**

7417-BR	Body Only	Brass	4.40
7418-R	Gasket	Rubber	1.95

**TEEJET ASSEMBLIES**

**Male Bodies**

1336-BR	1/8" MPT	Brass	2.63
1322-BR	1/4" MPT	Brass	2.63
8028-NY	1/4" MPT	Nylon	1.88



**Female Bodies**

1335-BR	1/8" FPT	Brass	2.63
1321-BR	1/4" FPT	Brass	2.63
8029-NY	1/4" FPT	Nylon	1.82



**Caps**

8027-NY	Standard	Nylon	.35
---------	----------	-------	-----



**Strainer**

**Mesh**

5053-BR50	50	Brass	2.51
5053-BR100	100	Brass	2.51
8079-NY50	50	Nylon	.72
8079-NY100	100	Nylon	.72
2930-50	50 Screen Only		.45
2930-100	100 Screen Only		.45



**Check Valve Strainer**

4193-BR50	50	Brass	5.68
4193-BR100	100	Brass	5.68



**Slotted Strainer**

4514-NY25	25	Nylon	1.10
-----------	----	-------	------



DEALER SCHEDULE THIS PAGE.....403

**ALL PRICES SUBJECT TO CHANGE WITHOUT NOTICE.**

# FloodJet

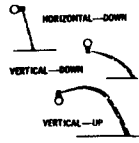

The FloodJet and Nozzles produce a very wide deflector type spray pattern.

Round orifice minimizes clogging.

Lower spraying pressures produce coarse particles minimizing drift. As shown here, nozzles may be mounted vertically or horizontally.

Spray overlap can be varied by raising or lowering boom - and by rotating boom.



(TKSS) FloodJet Nozzle 1/4-3/4"

# Tips Only For All Standard Nozzles

Tip Number*	Cap. Gal. Per Acre	Material Types
730077	5	Brass
730116	7.5	Brass
730385	25	Brass
730462	30	Brass
730616	40	Brass
8001	6.4	Brass, Stainless Steel
80015	9.7	Brass, Stainless Steel, Visi-Flow
8002	12.9	Stainless Steel, Visi-Flow
8003	19	Brass, Stainless Steel, Visi-Flow
8004	26	Brass, Stainless Steel
8005	32	Brass, Stainless Steel
8006	39	Brass, Stainless Steel
8008	52	Brass, Stainless Steel
8001E	4.3	Brass, Stainless Steel
80015E	6.4	Brass
8002E	8.6	Brass, Stainless Steel
8003E	12.9	Brass, Stainless Steel, Visi-Flow
8004E	17.2	Brass, Stainless Steel
8005E	21	Brass, Stainless Steel
8006E	26	Brass, Stainless Steel
8008E	34	Brass, Stainless Steel

NOTE - Letter "E" designates Pre-Emergence Brand Type.  
NOTE - Capacity figured at 4 mph, 30 psi, 30" row spacing.

Gallons per acre based on 40' Spacing



TYPE		Liquid Pressure in PSI	Capacity in GPM	4 MPH	5 MPH	6 MPH	8 MPH	10 MPH	12 MPH	14 MPH	16 MPH	20 MPH
TK-SS1 (100 Mesh)		10	.10	3.7	3.0	2.5	1.9	1.5	1.2	1.1	.93	.74
		20	.14	5.3	4.2	3.5	2.6	2.1	1.8	1.5	1.3	1.1
		30	.17	6.4	5.1	4.3	3.2	2.6	2.1	1.8	1.6	1.3
		40	.20	7.4	5.9	5.0	3.7	3.0	2.5	2.1	1.9	1.5
TK-SS1.5 (50 Mesh)		10	.15	5.6	4.5	3.7	2.8	2.2	1.9	1.6	1.4	1.1
		20	.21	7.9	6.3	5.3	3.9	3.2	2.6	2.3	2.0	1.6
		30	.26	9.7	7.7	6.4	4.8	3.9	3.2	2.8	2.4	1.9
		40	.30	11.1	8.9	7.4	5.6	4.5	3.7	3.2	2.8	2.2
TK-SS2 (50 Mesh)	% K-SS2	10	.20	7.4	5.9	5.0	3.7	3.0	2.5	2.1	1.9	1.5
		20	.28	10.5	8.4	7.0	5.3	4.2	3.5	3.0	2.6	2.1
		30	.35	12.9	10.3	8.6	6.4	5.1	4.3	3.7	3.2	2.6
		40	.40	14.9	11.9	9.9	7.4	5.9	5.0	4.2	3.7	3.0
TK-SS2.5 (50 Mesh)	%K-SS2.5	10	.25	9.3	7.4	6.2	4.6	3.7	3.1	2.7	2.3	1.9
		20	.35	13.1	10.5	8.8	6.6	5.3	4.4	3.8	3.3	2.6
		30	.43	16.1	12.9	10.7	8.0	6.4	5.4	4.6	4.0	3.2
		40	.50	18.6	14.9	12.4	9.3	7.4	6.2	5.3	4.6	3.7
TK-SS3 (50 Mesh)	%K-SS3	10	.30	11.1	8.9	7.4	5.6	4.5	3.7	3.2	2.8	2.2
		20	.42	15.8	12.6	10.5	7.9	6.3	5.3	4.5	3.9	3.2
		30	.52	19.3	15.4	12.9	9.7	7.7	6.4	5.5	4.8	3.9
		40	.60	22	17.8	14.9	11.1	8.9	7.4	6.4	5.4	4.5
TK-SS4		10	.40	14.9	11.9	9.9	7.4	5.9	5.0	4.2	3.7	3.0
		20	.57	21	16.8	14.0	10.5	8.4	7.0	6.0	5.3	4.2
		30	.69	26	21	17.2	12.9	10.3	8.6	7.4	6.4	5.1
		40	.80	30	24	19.6	14.9	11.9	9.9	8.5	7.4	5.9
TK-SS5	%K-SS5	10	.50	18.6	14.9	12.4	9.3	7.4	6.2	5.3	4.6	3.7
		20	.71	26	21	17.5	13.1	10.5	8.8	7.5	6.6	5.3
		30	.87	32	26	21	16.1	12.9	10.7	9.2	8.0	6.4
		40	1.0	37	30	25	18.6	14.9	12.4	10.6	9.3	7.4
TK-SS7.5	%K-SS7.5	10	.75	28	22	18.6	13.9	11.1	9.3	8.0	7.0	5.6
		20	1.1	39	32	26	19.7	15.8	13.1	11.3	9.8	7.9
		30	1.3	48	39	32	24	19.3	16.1	13.8	12.1	9.7
		40	1.5	56	45	37	28	22	18.6	15.9	13.9	11.1
TK-SS10	%K-SS10	10	1.0	37	30	25	18.6	14.9	12.4	10.6	9.3	7.4
		20	1.4	53	42	35	26	21	17.5	15.0	13.1	10.5
		30	1.7	64	51	43	32	26	21	18.4	16.1	12.9
		40	2.0	74	59	50	37	30	25	21	18.6	14.9
TK-SS15	%K-SS15	10	1.5	56	45	37	28	22	18.6	15.9	13.9	11.1
		20	2.1	79	63	53	39	32	26	23	19.7	15.8
		30	2.6	96	77	64	48	39	32	28	24	19.3
		40	3.0	111	89	74	56	45	37	32	28	22
TK-SS20	%K-SS20	10	2.0	74	59	50	37	30	25	21	18.6	14.9
		20	2.8	105	84	70	53	42	35	30	26	21
		30	3.5	129	103	86	64	51	43	37	32	26
		40	4.0	149	119	99	74	59	50	42	37	30
TK-SS30		10	3.0	111	89	74	56	45	37	32	28	22
		20	4.2	158	126	105	79	63	53	45	39	32
		30	5.2	193	154	129	96	77	64	55	48	39
		40	6.0	223	178	149	111	89	74	64	56	45

Order No.	Price
TKBR-(Specify No.) ... Brass Flood Jet Tip	\$7.81
TKSS-(Specify No.) ... Stainless Steel Flood Jet Tip	15.01
TKVS-(Specify No.) ... Visi-Flow Flood Jet Tip	13.52

## NYGLASS FLOODING TIPS

Numbers Interchange With Other Leading Nozzle Tip Manufacturers. See The Table Above For Tip Specifications.

Tip No.	Description	Price
FT02.5	NYGLASS Tip	\$1.20
FT03	NYGLASS Tip	1.20
FT05	NYGLASS Tip	1.20
FT07.5	NYGLASS Tip	1.20
FT10	NYGLASS Tip	1.20
FT15	NYGLASS Tip	1.20
FT20	NYGLASS Tip	1.20

## Prices For The Above Tips

Tip Type	Price
Brass Tips	\$4.83
S. Steel Tips	14.21
Visi-Flow Tips	7.08

\* To Order Specify Number and Material Type.

Tip Number	Cap. Gal. Per Acre	Description	Price
150015	6.4	Brass Double Outlet	\$10.36
15002	8.6	Brass Double Outlet	10.36
15003	12.9	Brass Double Outlet	10.36
15004	17.2	Brass Double Outlet	10.36
15006	25.8	Brass Double Outlet	10.36
15009	38.7	Brass Double Outlet	10.36
3942-BR		Brass Blank (Disc)	.33

NOTE - Capacity figured at 4 mph, 30 psi, 30" row spacing.

## FLOOD TIP ADAPTER

Tough corrosion resistant nylon.  
Easy change over from flat spray to flood tip in field.  
Cuts down on wind drift.  
Low initial cost.

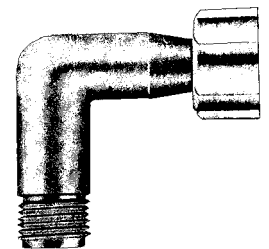

No.	Price
100FTA	Flood Tip Adapter \$3.20

**Call Toll-Free 1-800-444-8666**

DEALER SCHEDULE THIS PAGE.....403

## Wide Angle ConeJet Spray Tips

For livestock & poultry cooling

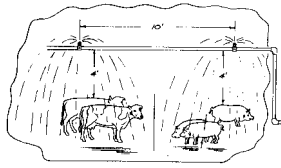

No.	GPM	Price
T2W .....	1.7 .....	\$6.17
T3W .....	2.6 .....	6.17

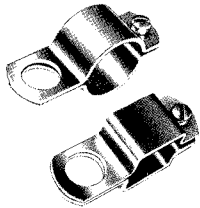

### Vari-Spacing Pipe Clamps

Boom Clamps  
(Square & Round)  
For Use With Hose  
Connections

No.	Description	Price
VSCR-34 .....	3/4" Round Pipe, Steel .....	\$5.17
VNYR-34 .....	3/4" Round Pipe, Nylon .....	2.05
VSCR-10 .....	1" Round Pipe, Steel .....	5.17
VSCR-125 .....	1-1/4" Round Pipe, Steel .....	8.67
VSCS-10 .....	1" Square Pipe, Steel .....	5.95

## TeeJet Vari-Spacing Nozzles

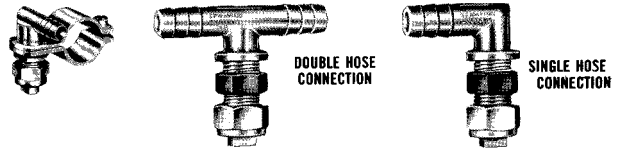

Note: Prices do not include tip, strainer assembly & cap.

No.	Size	Description	Price
DHC-38 .....	3/8" .....	Nylon "T" Connector .....	\$1.20
DHC-12 .....	1/2" .....	Nylon "T" Connector .....	1.38
DHC-34 .....	3/4" .....	Nylon "T" Connector .....	2.32
SHC-38 .....	3/8" .....	Nylon "L" Connector .....	1.20
SHC-12 .....	1/2" .....	Nylon "L" Connector .....	1.38
SHC-34 .....	3/4" .....	Nylon "L" Connector .....	2.32
DHC-38-BR .....	3/8" .....	Brass "T" Connector .....	12.04
DHC-12-BR .....	1/2" .....	Brass "T" Connector .....	9.11
SHC-38-BR .....	3/8" .....	Brass "L" Connector .....	12.04
SHC-12-BR .....	1/2" .....	Brass "L" Connector .....	9.11
TL .....		Nylon Lock Nut .....	.29

### Fused Bronze Filter



#9106 Fused Bronze Filter - - - Brass with fused bronze filter element equivalent to 300 mesh screen. For use with extra low capacity TeeJet Tips.

No.	Price	
9106 .....	Filter .....	\$2.61



### Gate Valves Non-Rising Stem Solid Wedge Celecon

No.	IPTF	Price
2004 .....	1-1/4" .....	36.80
2006 .....	2" .....	58.30

## BALL VALVES

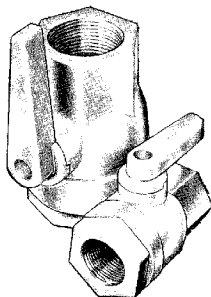

Precision Injection Molded.  
Large Flow Ports.  
Quarter Turn On-Off.  
Low Initial Cost.  
Furnished With Grease Fitting.  
Wiping Action Of Ball On Seals Pre-  
vents Deposit Build-Up.  
Viton Seals Standard

No.	IPTF	Price
H120 .....	1/2" .....	\$11.61
H100 .....	1" .....	18.31
H150 .....	1-1/2" .....	47.00



Nylon  
Single  
Hose  
Connection  
3/8" & 1/2"

No.	Size	Price
3838D .....	3/8" .....	\$1.20

No.	Size	Price
3812D .....	1/2" .....	\$1.38

### 3 BARB NOZZLE BODY

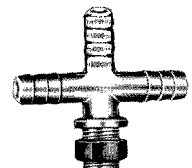

No.	Desc.	Price
T38CN ...	3/8" Barb ....	\$1.63
T12CN ...	1/2" Barb ....	2.08
T34CN ...	3/4" Barb ....	3.00

## Straight Compression Stop Valve



These inexpensive celcon valves are excellent throttling valves for low volume centrifugal systems

No.	IPTF	Price
900-12 .....	1/2" .....	\$8.00
900-34 .....	3/4" .....	8.35

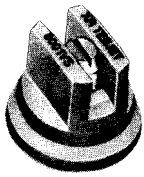

**XR TeeJet** EXTENDED RANGE  
FLAT SPRAY TIPS  
with *VisiFlo* color coding

**LOWER PRESSURE:**

Excellent spray distribution  
Larger droplets for better drift control  
Longer wearing

**HIGHER PRESSURE:**

Excellent spray distribution  
Smaller droplets for good coverage  
Excellent canopy penetration

**IDEAL FOR AUTOMATIC SPRAYER CONTROLS**

The patented design automatically compensates for changes in pressure actuated by today's automatic sprayer control systems. When the sprayer control drops pressure as you slow down, the tip maintains the necessary spray overlap. The same feature compensates for abrupt changes in boom height caused by rough or uneven terrain Result: less skips.

**Features:**

Excellent spray distribution over a wide range of pressures (15-60 psi).  
Idea for rigs equipped with sprayer controllers.  
Reduces drift at lower pressures, better coverage at higher pressures.

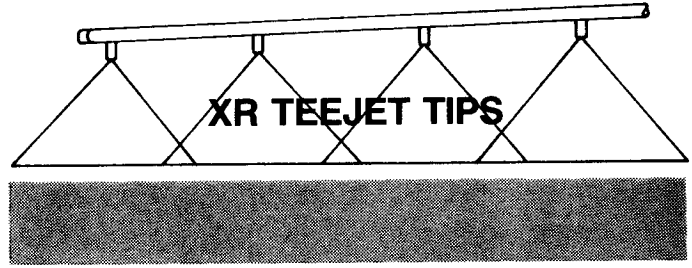
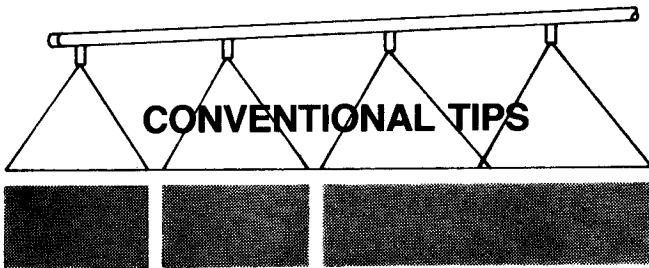

Spray skips with standard flat spray tips when boom is tilted or bounced.

Wider coverage of XR TeeJet spray patterns minimize spray skips . . . even at low pressures.

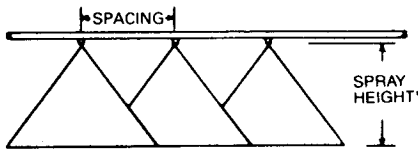

\*Adjust spray height in the field to overlap approximately 30% of each edge of pattern.

SUGGESTED MINIMUM SPRAY HEIGHT	
SPRAY ANGLE	SPRAY HEIGHT 20" SPACING
80°	17-19"
110°	10-12"

SEE p. 2 FOR A COMPLETE TABLE OF SPRAY HEIGHTS AND COVERAGES

**HOW TO ORDER:**

SPECIFY TIP NO.

Examples:

XR 8002VS—Stainless Steel with *VisiFlo* color coding

TIP COLOR	TIP NO. (Strainer Screen Size)		Liquid Pressure in PSI	Capacity 1 Nozzle in GPM	Capacity 1 Nozzle in oz./min.	GALLONS PER ACRE 20' SPACING				GALLONS PER ACRE 30' SPACING			
	80° SERIES	110° SERIES				5 MPH	6 MPH	7 MPH	8 MPH	5 MPH	6 MPH	7 MPH	8 MPH
Orange	XR8001 (100 Mesh)	XR11001 (100 Mesh)	15	.06	8	3.6	3.0	2.6	2.3	2.4	2.0	1.7	1.5
			20	.07	9	4.2	3.5	3.0	2.6	2.8	2.3	2.0	1.8
			30	.09	11	5.1	4.3	3.7	3.2	3.4	2.9	2.5	2.1
			40	.10	13	5.9	5.0	4.2	3.7	4.0	3.3	2.8	2.5
			60	.12	15	7.3	6.1	5.2	4.6	4.9	4.0	3.5	3.0
Green	XR80015 (100 Mesh)	XR110015 (100 Mesh)	15	.09	12	5.5	4.5	3.9	3.4	3.6	3.0	2.6	2.3
			20	.11	14	6.3	5.3	4.5	3.9	4.2	3.5	3.0	2.6
			30	.13	17	7.7	6.4	5.5	4.8	5.1	4.3	3.7	3.2
			40	.15	19	8.9	7.4	6.4	5.6	5.9	5.0	4.2	3.7
			60	.18	23	10.9	9.1	7.8	6.8	7.3	6.1	5.2	4.6
Yellow	XR8002 (50 Mesh)	XR11002 (50 Mesh)	15	.12	15	7.3	6.1	5.2	4.5	4.8	4.0	3.5	3.0
			20	.14	18	8.4	7.0	6.0	5.3	5.6	4.7	4.0	3.5
			30	.17	22	10.3	8.6	7.4	6.4	6.9	5.7	4.9	4.3
			40	.20	26	11.9	9.9	8.5	7.4	7.9	6.6	5.7	5.0
			60	.25	32	14.6	12.1	10.4	9.1	9.7	8.1	6.9	6.1
Blue	XR8003 (50 Mesh)	XR11003 (50 Mesh)	15	.18	23	10.9	9.1	7.8	6.8	7.3	6.1	5.2	4.5
			20	.21	27	12.6	10.5	9.0	7.9	8.4	7.0	6.0	5.3
			30	.26	33	15.4	12.9	11.0	9.7	10.3	8.6	7.4	6.4
			40	.30	38	17.8	14.9	12.7	11.1	11.9	9.9	8.5	7.4
			60	.37	47	22	18.2	15.6	13.6	14.6	12.1	10.4	9.1
Red	XR8004 (50 Mesh)	XR11004 (50 Mesh)	15	.24	31	14.5	12.1	10.4	9.1	9.7	8.1	6.9	6.1
			20	.28	36	16.8	14.0	12.0	10.5	11.2	9.3	8.0	7.0
			30	.35	45	21	17.2	14.7	12.9	13.7	11.4	9.8	8.6
			40	.40	51	24	19.8	17.0	14.9	15.8	13.2	11.3	9.9
			60	.49	63	29	24	21	18.2	19.4	16.2	13.9	12.1
Brown	XR8005 (50 Mesh)	XR11005 (50 Mesh)	15	.31	40	18.2	15.2	13.0	11.4	12.1	10.1	8.7	7.6
			20	.35	45	21	17.5	15.0	13.1	14.0	11.7	10.0	8.8
			30	.43	55	26	21	18.4	16.1	17.2	14.3	12.3	10.7
			40	.50	64	30	25	21	18.6	19.8	16.5	14.1	12.4
			60	.61	78	36	30	26	23	24	20	17.3	15.2
Gray	XR8006 (50 Mesh)	XR11006 (50 Mesh)	15	.37	47	22	18.2	15.6	13.6	14.5	12.1	10.4	9.1
			20	.42	54	25	21	18.0	15.8	16.8	14.0	12.0	10.5
			30	.52	67	31	26	22	19.3	21	17.2	14.7	12.9
			40	.60	77	36	30	25	22	24	19.8	17.0	14.9
			60	.74	95	44	36	31	27	29	24	21	18.2
White	XR8008 (50 Mesh)	XR11008 (50 Mesh)	15	.49	63	29	24	21	18.2	19.4	16.2	13.9	12.1
			20	.57	73	34	28	24	21	22	18.7	16.0	14.0
			30	.69	88	41	34	29	26	27	23	19.6	17.2
			40	.80	102	48	40	34	30	32	26	23	19.8
			60	.98	125	58	49	42	36	39	32	28	24

Now! - - Change Spray Tips  
Hand-Twist Quick

THE  
**Quick TeeJet**  
SYSTEM

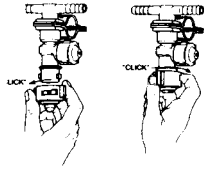

FOR USE WITH DRY BOOMS

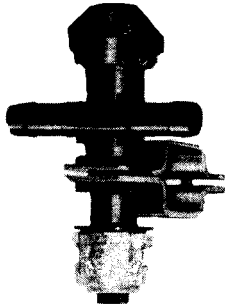

The QJ series low profile design allows maximum protection against damage. Available with single and double hose shanks for 3/8, 1/2 and 3/4" I.D. hose. Drip free shut-off. Opens at 10 psi. Standard diaphragm is EPDM with Viton optional. Maximum operating pressure 125 psi with optional 300 psi when used with high pressure Quick TeeJet Caps.

For Complete Assembly Order (1) Nozzle Body, (2) Clamp and (3) Cap and Gasket Set. Order Tips Separately.

ADAPTERS FOR RETROFITTING

Permit usage of Quick TeeJet caps and TeeJet tips with standard TeeJet Nozzle Bodies.

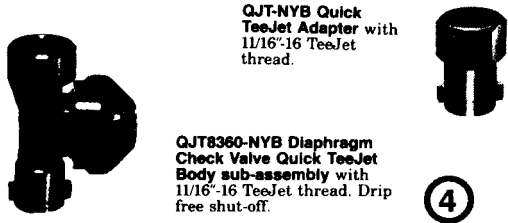

**QJT8360-NYB Diaphragm Check Valve Quick TeeJet Body sub-assembly with 11/16\"/>**

TYPICAL USE

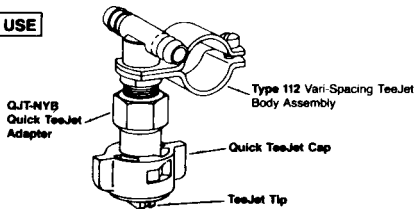

No.	Description	Price
QJT-NYB .....	Bodies using 8027 cap ...	\$4.91
QJT-8360-NYB ...	Bodies using 8027 cap ...	18.80

Retrofit Adapters are used with Standard TeeJet Nozzle Bodies and Clamps. Order 4 Retrofit Adapter and 3 Cap & Gasket Set (see above). Order Tips Separately.

**Quick TeeJet** NOZZLE BODY  
SUB-ASSEMBLIES

Quick TeeJets are carefully constructed in a reinforced design that utilizes extra tough nylon and Celon....weather and chemical resistant materials that withstand toughest field conditions....Easy to install on any boom system. Auto-align of flat spray tips.

		FOR DRY BOOMS	
No.	Description		Price
<b>Quick TeeJet nozzle body with Diaphragm Check Valve</b>			
22251-311-500NYB .....	1/2" Single hose shank .....		\$9.37
22251-311-750NYB .....	3/4" Single hose shank .....		9.37
-----			
22252-312-375NYB .....	3/8" Double hose shank .....		9.37
22252-312-500NYB .....	1/2" Double hose shank .....		9.37
22252-312-750NYB .....	3/4" Double hose shank .....		9.37
-----			
<b>Quick TeeJet nozzle body only.</b>			
18635-111-375NYB .....	3/8" Single hose shank .....		4.57
18638-111-500NYB .....	1/2" Single hose shank .....		4.57
-----			
18636-112-375NYB .....	3/8" Double hose shank .....		4.57
18639-112-500NYB .....	1/2" Double hose shank .....		4.57
-----			
18637-113-375NYB .....	3/8" Triple hose shank .....		4.57
18640-113-500NYB .....	1/2" Triple hose shank .....		4.57
-----			
<b>Vari-Spacing Quick TeeJet clamp - - For Above</b>			
QJ111-RD (Specify) .....	1/2, 3/4 or 1" Rd. clamp .....		3.00
QJ111-RD-114 .....	1-1/4" Round clamp .....		4.38
-----			
QJ111-SQ (Specify) .....	3/4 or 1" Square clamp .....		3.00
QJ111-SQ114 .....	1-1/4" Square clamp .....		3.00

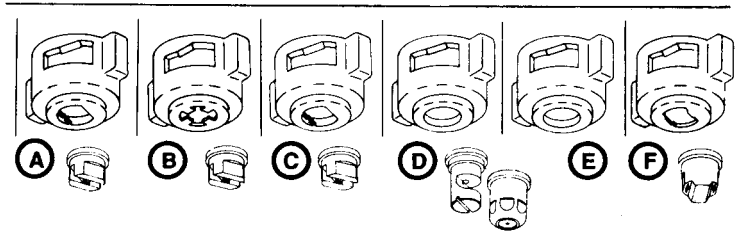

CAP & GASKET SET		FOR USE WITH TIPS	Price
A .....	25612-NYR-(Color)-CELR ...	Standard tips smaller than 8010 (Smaller Capacities) .....	LP (Brass) 8001 thru 8004
		One Spray plane direction ... LP (SS) 8001 thru 8005, XR 8001 thru 8008 ....	\$1.39

**Call Toll-Free**  
**1-800-444-8666**  
**Fax Toll-Free**  
**1-800-342-7252**

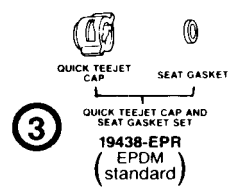

\*STANDARD WITH COLOR/CODE.... YELLOW (6). AVAILABLE WITH.... (1) BLACK, (2) WHITE, (3) RED, (4) BLUE, (5) GREEN, (6) YELLOW, (7) BROWN, (8) ORANGE

**HIGH QUALITY NYLON FITTINGS**

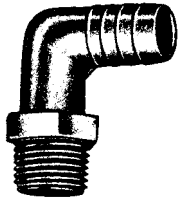

**NYLON ELBOWS**

No.	IPTM	Barb	Each
EL1412	1/4"	1/2"	\$ .86
EL1438	1/4"	3/8"	.92
EL3838	3/8"	3/8"	1.00
EL3812	3/8"	1/2"	.92
EL1238	1/2"	3/8"	.92
EL1212	1/2"	1/2"	.92
EL1258	1/2"	5/8"	1.17
EL1234	1/2"	3/4"	1.17
EL3438	3/4"	3/8"	1.12
EL3412	3/4"	1/2"	1.17
EL3458	3/4"	5/8"	1.17
EL3434	3/4"	3/4"	1.20
EL3410	3/4"	1"	1.30
EL1012	1"	1/2"	1.72
EL1034	1"	3/4"	1.55
EL1010	1"	1"	1.55
EL1141	1-1/4"	1"	2.80
EL114	1-1/4"	1-1/4"	2.95
EL112	1-1/2"	1-1/2"	4.10

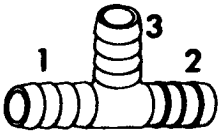

**NYLON INSERT TEES  
Three Hose Barbs**

No.	1	2	3	Price
3HB-14	1/4"	1/4"	1/4"	\$ .85
3HB-38	3/8"	3/8"	3/8"	.97
3HB-3812	1/2"	1/2"	3/8"	.97
3HB-12	1/2"	1/2"	1/2"	.95
3HB-58	5/8"	5/8"	5/8"	.98
3HB-3412	1/2"	1/2"	3/4"	2.95
3HB-34	3/4"	3/4"	3/4"	1.15
3HB-100	1"	1"	1"	1.43
3HB-114	1-1/4"	1-1/4"	1-1/4"	3.28
3HB-112	1-1/2"	1-1/2"	1-1/2"	3.94
3HB-200	2"	2"	2"	11.50

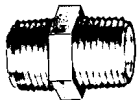

**NYLON  
Hex Center Close Nipples**

No.	IPTM	IPTM	Each
M-1400	1/4"	1/4"	\$ .47
M-3800	3/8"	3/8"	.52
M-1200	1/2"	1/2"	.53
M-3400	3/4"	3/4"	.80
M-1000	1"	1"	1.10
M-1140	1-1/4"	1-1/4"	2.10
M-1120	1-1/2"	1-1/2"	3.46
M-2000	2"	2"	4.21

**NYLON  
Hose Coupling**

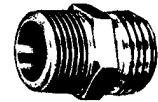

No.	IPTM	GHTM	Each
HC1434	1/4"	1/4"	\$ .98
HC3834	3/8"	3/4"	.70
HC1234	1/2"	3/4"	.70
HC3434	3/4"	3/4"	.81

**NYLON  
Hose Mender**

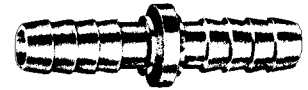

No.	Barb	Barb	Each
SHM1400	1/4"	1/4"	\$ .46
SHM3800	3/8"	3/8"	.52
SHM1200	1/2"	1/2"	.54
SHM5800	5/8"	5/8"	.60
SHM3400	3/4"	3/4"	.81
SHM1000	1"	1"	1.03
SHM114	1-1/4"	1-1/4"	1.97
SHM112	1-1/2"	1-1/2"	3.06
SHM200	2"	2"	8.90

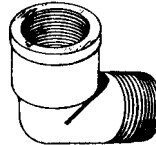

**NYLON  
Street Elbows  
Female Taper Pipe Thread  
Male Taper Pipe Thread**

No.	IPTF	IPTM	Each
SE12	1/2"	1/2"	\$2.50
SE34	3/4"	3/4"	3.60
SE100	1"	1"	7.30
SE114	1-1/4"	1-1/4"	9.18
SE112	1-1/2"	1-1/2"	9.45
SE200	2"	2"	11.50

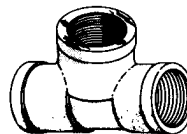

**NYLON TEE  
Female Taper  
Pipe Threads**

No.	IPTF	IPTF	IPTF	Price
TT12	1/2"	1/2"	1/2"	\$3.63
TT34	3/4"	3/4"	3/4"	4.55
TT100	1"	1"	1"	8.14
TT114	1-1/4"	1-1/4"	1-1/4"	11.21
TT112	1-1/2"	1-1/2"	1-1/2"	12.62
TT200	2"	2"	2"	17.23

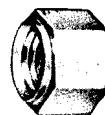

**NYLON Thread Caps-Female NPT-GHT**

No.	Price
N3400	GHTF Cap \$ .72
CP3400	IPTF Cap .88



**NYLON  
Hose Fittings  
Male Pipe Thread**

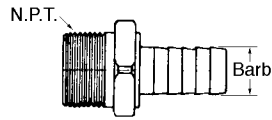

No.	IPTM	Barb	Each
A1414	1/4"	1/4"	\$ .48
A1438	1/4"	3/8"	.56
A1412	1/4"	1/2"	.52
A3814	3/8"	1/4"	.52
A3838	3/8"	3/8"	.52
A3812	3/8"	1/2"	.52
A1214	1/2"	1/4"	.57
A1238	1/2"	3/8"	.61
A1212	1/2"	1/2"	.66
A1258	1/2"	5/8"	.61
A1234	1/2"	3/4"	.72
A3438	3/4"	3/8"	.70
A3412	3/4"	1/2"	.70
A3458	3/4"	5/8"	.75
A3434	3/4"	3/4"	.80
A3410	3/4"	1"	1.03
A1034	1"	3/4"	1.26
A1010	1"	1"	1.26
A1114	1"	1-1/4"	1.76
A1141	1-1/4"	1"	1.86
A114	1-1/4"	1-1/4"	2.25
A114-112	1-1/4"	1-1/2"	2.26
A112-114	1-1/2"	1-1/4"	2.25
A112	1-1/2"	1-1/2"	2.60
A200	2"	2"	3.65

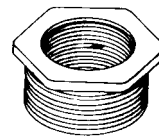

**NYLON  
Reducer Bushings**

No.	Male	Female	Each
RB3814	3/8"	1/4"	\$1.23
RB1238	1/2"	3/8"	1.20
RB3414	3/4"	1/4"	1.30
RB3412	3/4"	1/2"	1.35
RB1034	1"	3/4"	1.70
RB114-34	1-1/4"	3/4"	3.28
RB114-1	1-1/4"	1"	3.28
RB112-114	1-1/2"	1-1/4"	3.00
RB200-112	2"	1-1/2"	3.28
RB212-200	2-1/2"	2"	6.93
RB300-200	3"	2"	10.30

**NYLON  
Hose Couplings**



No.	GHTM	Barb	Each
D3438	3/4"	3/8"	\$ .78
D3412	3/4"	1/2"	.76
D3458	3/4"	5/8"	.76
D3434	3/4"	3/4"	.78

**Nylon Nuts  
GHTF & IPTF**



No.	Size	Each
B3400	3/4" GHTF Nut Only	\$ .57
B3500	3/4" IPTF Nut Only	.99

**Barbs For GHTF Or IPTF Nuts**



No.	Barb	Price
C1400	1/4"	\$ .40
C3800	3/8"	.40
C1200	1/2"	.40
C5800	5/8"	.48
C3400	3/4"	.48

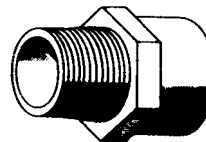

**Female Taper Pipe Thread  
And  
Male Garden Hose Thread**

No.	MGHT	FPT	Each
G3412	3/4"	1/2"	\$2.43
G3434	3/4"	3/4"	1.95

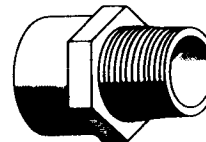

**Male Taper Pipe Thread  
And  
Female Garden Hose Thread**

No.	FGHT	MPT	Each
H3434	3/4"	3/4"	\$1.95

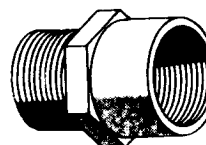

**Male Garden Hose Thread  
And  
Female Garden Hose Thread**

No.	MGHT	FGHT	Each
I3434	3/4"	3/4"	\$2.40

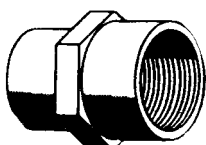

**Female Garden Hose Thread  
And  
Female Taper Pipe Thread**

No.	FGHT	FPT	Each
J3412	3/4"	1/2"	\$2.40

## High Quality Chemical Resistant Agricultural Spray Hose

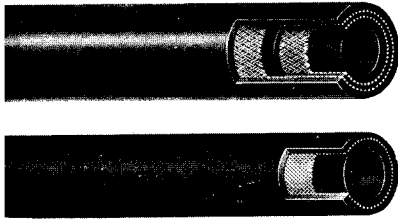

No.	Size	Pressure	Reel Range	Per C/Ft.
SH-04-2	1/4" x 2 Spiral	225	500'-700'	\$193.00
SH-06-2	3/8" x 2 Spiral	200	500'-700'	216.00
SH-08-2	1/2" x 2 Spiral	200	500'-700'	282.00
SH-10-2	5/8" x 2 Spiral	200	500'-700'	292.00
SH-12-2	3/4" x 2 Spiral	200	500'-700'	302.00
SH-16-4	1" x 4 Spiral	200	250'-400'	322.00
SH-20-4	1-1/4" x 4 Spiral	200	250'-400'	632.50
SH-24-4	1-1/2" x 4 Spiral	200	250'-400'	637.00

Dealer Schedule: 1' To 50' ..... 102  
 51' To Less Than A Full Reel ..... 203  
 Full Reel Or More ..... 33/133

## Flexible Plastic E.V.A. Tubing

Applying all NH<sub>3</sub> and Liquid Fertilizer Solutions

No.	Size	Reel Size	Per C/Ft.
EVA-04	1/4"	500'	\$91.00
EVA-06	3/8"	500'	134.25
EVA-08	1/2"	500'	155.70
EVA-10	5/8"	500'	216.59
EVA-12	3/4"	250'	282.80
EVA-16	1"	100'	358.00

Dealer Schedule: 1' to 50' ..... 102  
 51' To Less Than A Full Reel ..... 203  
 Full Reel Or More ..... 33/133

## PVC Clear Tubing - FDA Grade



Transparent tubing permits visual inspection of flow. Extremely flexible even at 0° F. Excellent flow characteristics. Chemical resistant. Packaged in 100 foot lengths.

No.	I.D.	O.D.	Wall	PSI*	Per C/Ft.
2T10-0608	3/8"	1/2"	1/16"	45	\$28.10
2T10-0812**	1/2"	3/4"	1/8"	45	78.70
2T10-1014	5/8"	7/8"	1/8"	45	94.40
2T10-1216**	3/4"	1"	1/8"	45	101.20
2T10-1620	1"	1-1/4"	1/8"	45	141.63

\*Maximum working pressure at room temperature.

\*\* Frequently used as drop tubes on granular applicators.

Dealer Schedule:

Full Package.....153 Broken Package.....203

## POLYPROPYLENE OPW KAMLOCK COUPLINGS

Polypropylene items should operate within the following temperatures.

0 Degrees F ..... Pressure Should Not Exceed 100 PSI.  
 100 Degrees F ..... Pressure Should Not Exceed 125 PSI.  
 150 Degrees F ..... Pressure Should Not Exceed 70 PSI.



No.	Size	Price	No.	Size	Price
KL-075A	3/4"	\$6.20	KL-075B	3/4"	\$15.05
KL-100A	1"	6.70	KL-100B	1"	18.55
KL-150A	1-1/2"	7.55	KL-150B	1-1/2"	21.40
KL-200A	2"	8.70	KL-200B	2"	25.25



No.	Size	Price	No.	Size	Price
KL-075C	3/4"	\$15.05	KL-075D	3/4"	\$15.05
KL-100C	1"	18.55	KL-100D	1"	18.55
KL-150C	1-1/2"	21.40	KL-150D	1-1/2"	21.40
KL-200C	2"	25.25	KL-200D	2"	25.25



No.	Size	Price	No.	Size	Price
KL-075E	3/4"	\$6.70	KL-075F	3/4"	\$6.70
KL-100E	1"	7.55	KL-100F	1"	7.55
KL-150E	1-1/2"	7.85	KL-150F	1-1/2"	7.85
KL-200E	2"	10.10	KL-200F	2"	10.10



No.	Size	Price	No.	Size	Price
KL-075DP	3/4"	\$6.50	KL-075DC	3/4"	\$15.05
KL-100DP	1"	6.60	KL-100DC	1"	18.00
KL-150DP	1-1/2"	7.25	KL-150DC	1-1/2"	21.40
KL-200DP	2"	9.80	KL-200DC	2"	25.25

Dealer Schedule.....403



## Nylon Plugs Style TPS -Square Head-NPT

No.	IPTM	Price	No.	IPTM	Price
NP-002	1/8"	\$.46	NP-100	1"	.91
NP-004	1/4"	.52	NP-104	1-1/4"	1.65
NP-006	3/8"	.50	NP-108	1-1/2"	2.20
NP-008	1/2"	.54	NP-200	2"	2.96
NP-012	3/4"	.72			

Dealer Schedule.....103

# LINE STRAINERS

**Repair Parts**

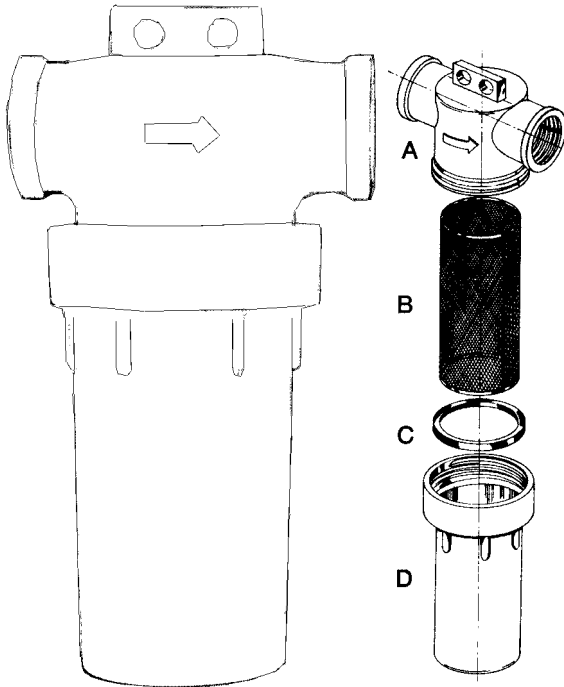

**SPECIFICATIONS:** Strainer made from tough corrosion resistant nylon. Stainless steel screens in 40 or 80 mesh. Strainers easily cleaned without tools. High capacity - - - minimum pressure drop. Hypalon gasket. Screen ends soldered dipped. Working pressure 100 PSI. Install strainer on suction side of roller pumps and piston pumps. Install strainer on discharge side of centrifugal pumps.

Order No.	Ports	Mesh	Price
PKNS-34040	3/4"	40	\$16.50
PKNS-34080	3/4"	80	16.75
PKNS-10040	1"	40	16.50
PKNS-10080	1"	80	16.75
PKNS-11440	1-1/4"	40	40.80
PKNS-11240	1-1/2"	40	40.80

**"B" Replacement Screens**

BNS-341-40	3/4" & 1" Screen (40 Mesh)	4.60
BNS-341-80	3/4" & 1" Screen (80 Mesh)	4.85

**"C" Cover Gasket**

CNS-341R	3/4" & 1" Gasket (Rubber)	2.55
CNS-341V	3/4" & 1" Gasket (Viton)	3.90

DEALER SCHEDULE: Whole Goods.....203      Parts.....152

## Suction Strainers

TYPE 7130  
SUCTION STRAINERS



No.	Barb	Mesh	Price
7130-2	3/4"	40	\$45.20
7130-4	5/8"	80	45.20



**Nylon**

7130-7	3/4"	40	14.89
--------	------	----	-------

DEALER SCHEDULE: Strainers.....203

## PVC Tubing / Hose Cutter

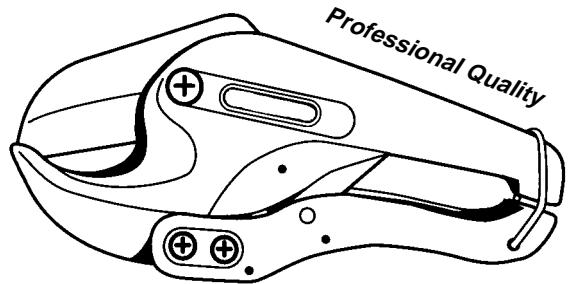

**Features:** Cast Alloy Construction, Chrome Plated High Carbon Steel Blade, Exclusive Angle Cutting Feature, Locking Handle For Safety, Capacity 1/8" to 1-5/8"

No.	Description	Price
GH-119	PVC Tubing/Hose Cutter	\$33.50

Dealer Schedule.....402

**ALL PRICES ARE SUBJECT TO CHANGE WITHOUT NOTICE.**

**Call Toll-Free 1-800-444-8666**

*Centralize*  
With  
*Central!*

# GunJet SPRAY GUNS

## Series #143



3/4" F.G.H.T. connection and mounting ring.

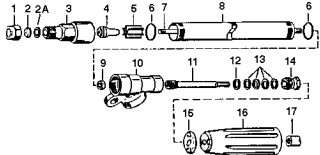

Heavy duty spray gun for livestock, orchard and field spot spraying and all related uses. Designed for pressures up to 800 PSI. Spray adjustable from straight stream through full cone spray. Complete selection of capacity ranges, with special hardened stainless steel orifice disc tips. Choice of trigger action or turn-handle control.

Order No.	Ref.	Description	Price
143-D6	2	Orifice Disc, S-Steel	\$1.48
143-10566	3	Nozzle Housing, Alum.	17.18
143-10571	5	Guide Vane, Alum.	7.82
143-6943	6	Gasket, Alum. (2 Req'd)	1.46
143-5882	11	Hand Grip Stud, Plated	10.62
143-5883	12	Packing Washer, Alum.	1.46
143-5811	14	Packing Screw, Alum.	3.27
143-5994	16	Hand Grip, Poly. Chloride	9.05
143-SPK		Parts Kit (Ref. 2A, 4, 13)	28.50

## Series #23

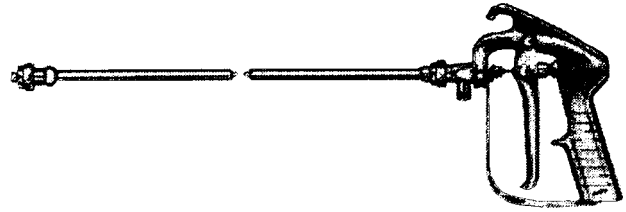

Flow Rates Up To 5 GPM  
Pressures From 250 To 1000 PSI  
Pistol Grip With Trigger Lock

Designed so that only inlet body, cap and spray tip are touched by spray chemicals. Supplied in choice of brass or stainless steel 1/4" NPS (M) inlet connection. Strong Aluminum alloy handle. Teflon valve seat and packing and packing and stainless steel valve stem. For use with TeeJet spray tip or adjustable ConeJet and MuliteeJets.

No.	Description	Price
23HBR	Brass Gun, with cap, less tip	\$68.71
23L-7676-24	Gun for Riding Sprayer, less tip	112.19
5500X3	Adjustable Tip, Stream to Cone	18.83
23L-7676-SPK	Parts Kit	16.80

## #23 Hand Gun Extension Tubing



No.	Description	Price
7715-18	18" Extension	\$14.52
7715-24	24" Extension	15.68
7715-36	36" Extension	19.86

## #23 Hand Gun Extension Swivel Adapters



No.	Description	Price
1414F	1/4" IPTF x 1/4" IPTF	\$4.06
1438F	1/4" IPTF x 3/8" IPTF	5.36

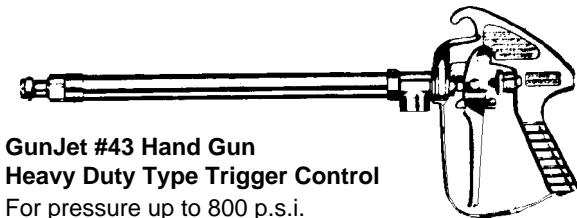

**GunJet #43 Hand Gun Heavy Duty Type Trigger Control**

For pressure up to 800 p.s.i.

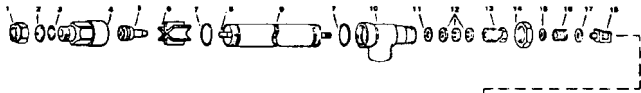

As trigger is drawn back, valve moves from shut-off position to initial wide angle cone spray to continuously narrower cone sprays to final straight stream. Knurled ring is adjustable to stop trigger at any desire position.

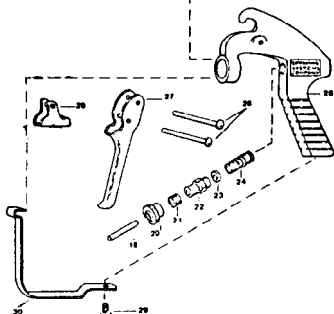

No.	Ref.	Description	Price
43H-D	2	Orifice Disc	\$1.50
43H-4743*	3	Gasket, Nylon	1.45
43H-6492	10	Inlet Body	28.67
43H-6602*	12	Packing	3.36

\* Included In Repair Kit

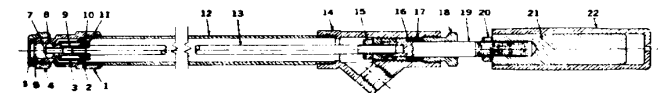

GunJet #18AL -- Length 20" -- Weight 1 lb., Aluminum 1/4" NPT (F) Inlet Connection.

No.	Ref.	Description	Price
5798-NY*	10	Seat, Nylon	\$5.78

DEALER SCHEDULE THIS PAGE:  
Complete Guns.....203  
Repair Parts.....152

PRICES ARE SUBJECT TO CHANGE WITHOUT NOTICE.

**G&G**

**Aetna**

**Elston Gopher-Getter**

***Drives Roller Chain***

***Pioneer***

**HUB CITY**

***IPTCI***

**DARE**

**Kondex**

**Neapco**

**National**

***SPRAY-ON***

**Seals**

***Products***

# Central Supply & Rubber Company

Toll-Free: 1-800-444-8666 Fax: 1-800-342-7252

Visit Our Web Site at: [www.centralsupplyandrubber.com](http://www.centralsupplyandrubber.com)

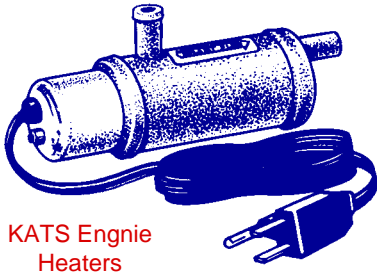

KATS Engine Heaters

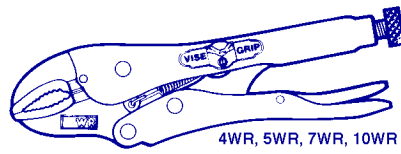

4WR, 5WR, 7WR, 10WR  
Vise-Grip Tools

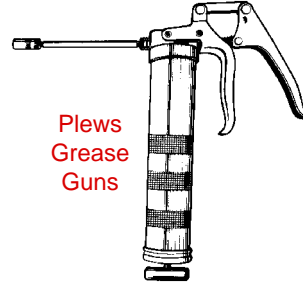
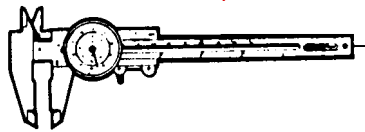

Plews Grease Guns

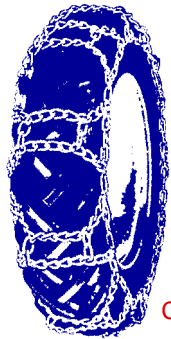
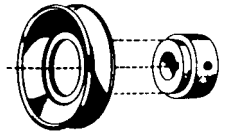

Tire Chains

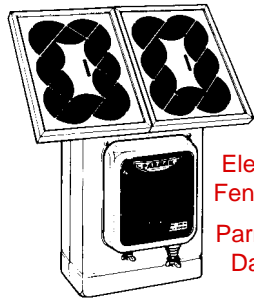

Electric Fencers  
Parmak Dare

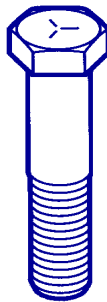

Fasteners

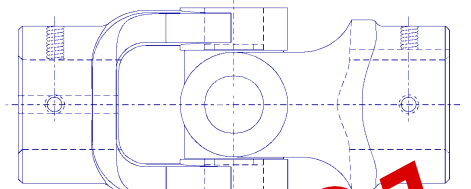
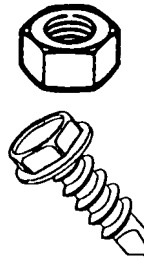

U-bolts

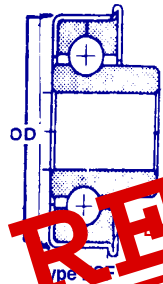

Bearing

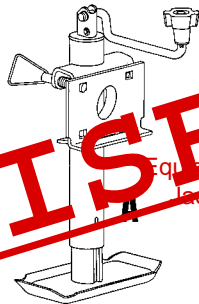

Equipment Jacks



Drill Bits

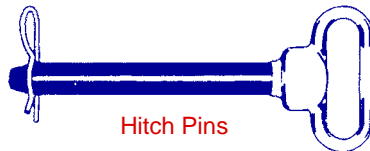

Hitch Pins

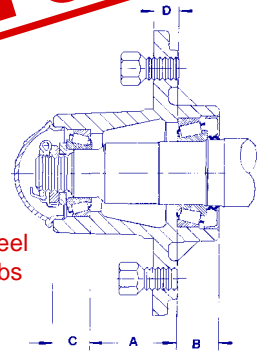

Wheel Hubs

506-3192  
50603192

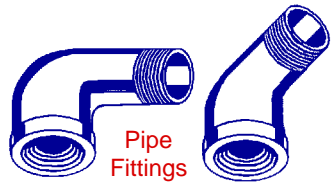

Pipe Fittings



Hydraulic Cylinders

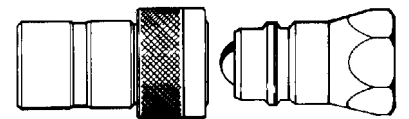

Parker/Pioneer Hyd. Couplers

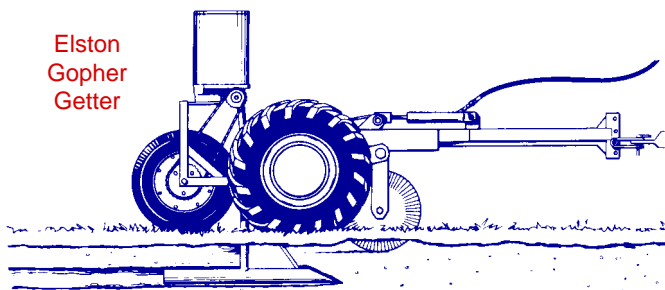

Elston Gopher Getter



Hydraulic Hose

